

1200V 12A 1.25Ω N-ch Power MOSFET

Description

WMOS™ D1 is Wayon's 1st generation VDMOS family that is dramatic reduction in on-resistance and ultra-low gate charge for applications requiring high power density and high efficiency. And it is very robust and RoHS compliant.

Features

- Typ. $R_{DS(on)}=1.25\Omega@V_{GS}=10V$
- 100% avalanche tested
- Pb-free, Halogen free

Applications

- SMPS
- Charger
- DC-DC

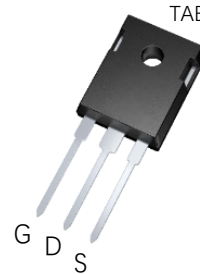
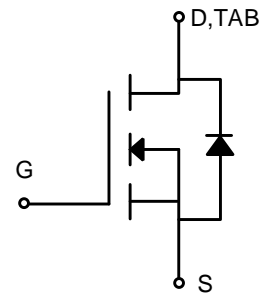
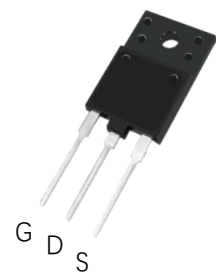
TO-247

TO-3PF

Absolute Maximum Ratings ($T_C=25^\circ\text{C}$)

Parameter	Symbol	WMJ12N120D1	WMX12N120D1	Unit
Drain-source voltage	V_{DS}	1200		V
Gate-source voltage	V_{GS}	± 30		V
Continuous drain current	I_D	12		A
Pulsed drain current	I_{DM}	48		A
Avalanche energy, single pulse	E_{AS}	700		mJ
Power dissipation	P_D	278	90.6	W
Derate above 25°C		2.22	0.7	W/°C
Operating junction temperature	T_j	-55~150		°C
Storage temperature	T_{stg}	-55~150		°C
Continuous diode forward current	I_S	12		A
Diode pulse current	I_{Spulse}	48		A

Thermal Characteristic

Thermal resistance, junction-to-case	$R_{\theta JC}$	0.45	1.38	°C/W
Thermal resistance, junction-to-ambient	$R_{\theta JA}$	50	50	°C/W

Electrical Characteristics of MOSFET

				Min.	Typ.	Max.	
Drain-source break down voltage	BV_{DSS}	$I_D=250\mu A, V_{GS}=0V$	$T_C=25^\circ C$	1200	-	-	V
Gate threshold voltage	$V_{GS(th)}$	$I_D=250\mu A, V_{DS}=V_{GS}$	$T_J=25^\circ C$	2.5	3.5	4	V
Drain-source leakage current	I_{DSS}	$V_{DS}=1200V, V_{GS}=0V$	$T_J=25^\circ C$	-	-	1	μA
		$V_{DS}=960V, V_{GS}=0V$	$T_J=125^\circ C$	-	-	400	μA
Gate-source leakage current,forward	I_{GSSF}	$V_{DS}=0V, V_{GS}=30V$	$T_J=25^\circ C$	-	-	100	nA
Gate-source leakage current,reverse	I_{GSSR}	$V_{DS}=0V, V_{GS}=-30V$	$T_J=25^\circ C$	-	-	-100	nA
Drain-source on-state resistance	$R_{DS(ON)}$	$V_{GS}=10V, I_D=6A$	$T_J=25^\circ C$	-	1.25	1.4	Ω
Transconductance	G_{fs}	$V_{DS}=15V, I_D=6A$	$T_J=25^\circ C$	-	11.6	-	S

Dynamic Characteristics of MOSFET ($T_C=25^\circ C$)

				Min.	Typ.	Max.	
Input capacitance	C_{iss}	$f=1MHz, V_{DS}=25V, V_{GS}=0V$		-	3624	-	pF
Output capacitance	C_{oss}			-	243	-	pF
Reverse transfer capacitance	C_{rss}			-	28.7	-	pF
Gate to source charge	Q_{gs}	$V_{DD}=600V$		-	24.7	-	nC
Gate to drain charge	Q_{gd}	$I_D=6A$		-	32.8	-	nC
Total gate charge	Q_g	$V_{GS}=0$ to 10V		-	94	-	nC

Switching Characteristics of MOSFET ($T_C=25^\circ C$)

				Min.	Typ.	Max.	
Turn-on delay time	$t_{d on}$	$V_{DS}=600V, I_D=6A,$ $R_G=4.7\Omega, V_{GS}=15V$		-	66.2	-	ns
Rise time	t_r			-	58	-	ns
Turn-off delay time	$t_{d off}$			-	286	-	ns
Fall time	t_f			-	62	-	ns

Characteristics of Body Diode ($T_C=25^\circ C$)

				Min.	Typ.	Max.	
Forward voltage	V_{SD}	$I_{SD}=12A, V_{GS}=0V$		-	-	1.5	V
Reverse recovery time	t_{rr}	$I_S=12A, V_{GS}=0V$ $di/dt=100A/\mu s$		-	1.9	-	μs
Reverse recovery current	I_{rr}			-	26.3	-	A
Recovery charge	Q_{rr}			-	25	-	μC

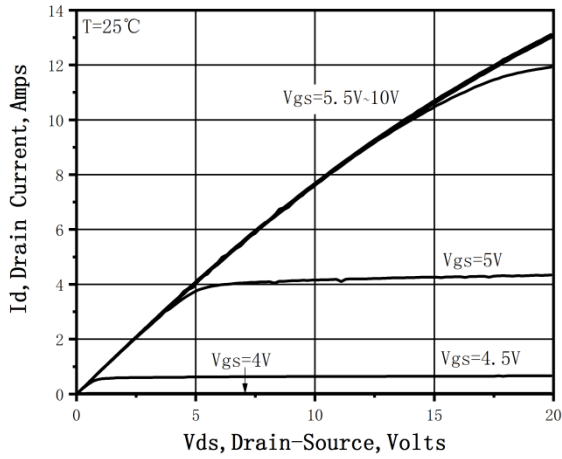

Figure 1. On-Region Characteristics

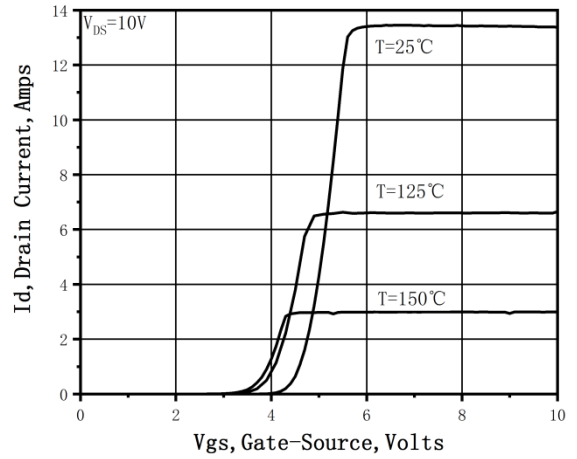

Figure 2. Transfer Characteristics

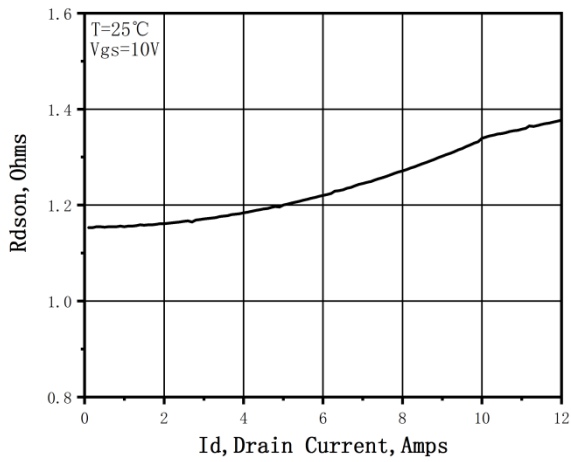

Figure 3. Static Drain-Source On Resistance

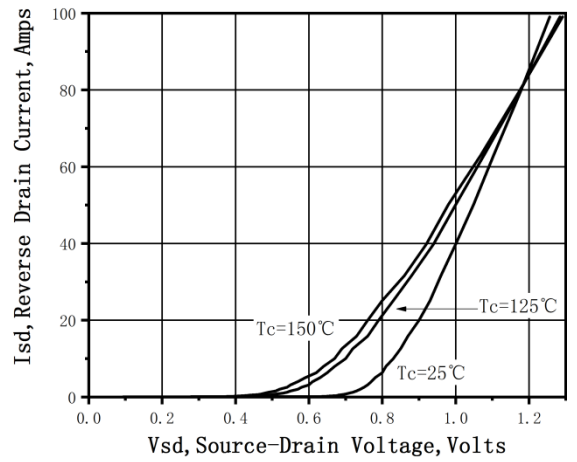

Figure 4. Typical Body Diode Transfer Characteristics

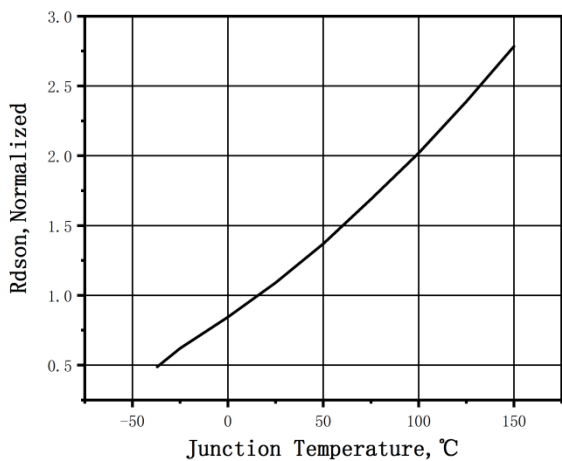

Figure 5. Normalized R_{DS(on)} vs. Temperature

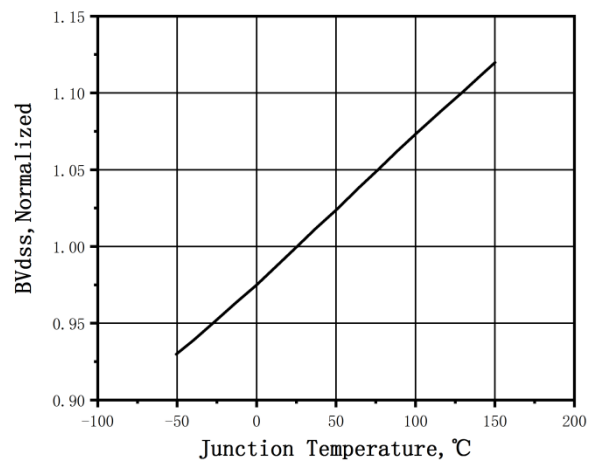

Figure 6. Normalized BV_{DSS} vs. Temperature

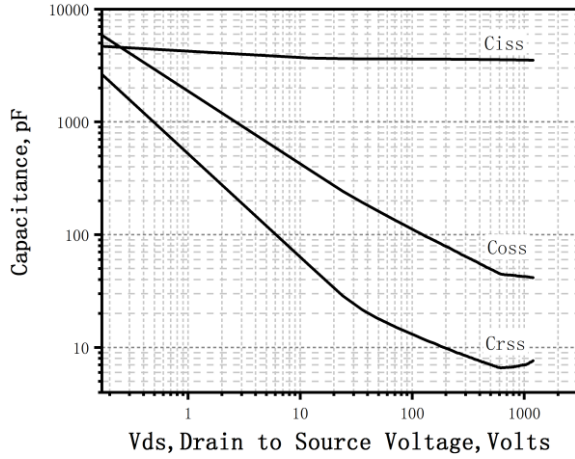

Figure 7. Capacitance Characteristics

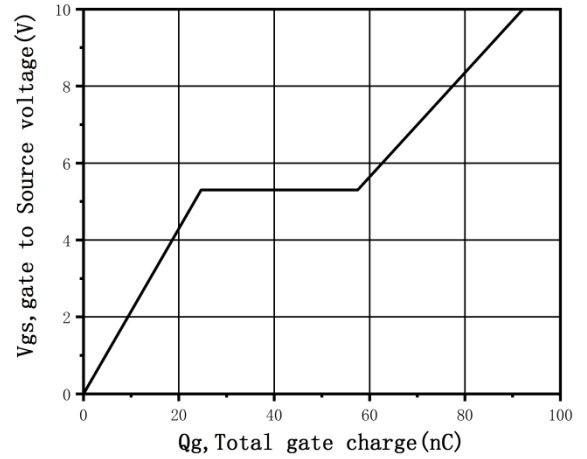

Figure 8. Gate Charge Characteristics

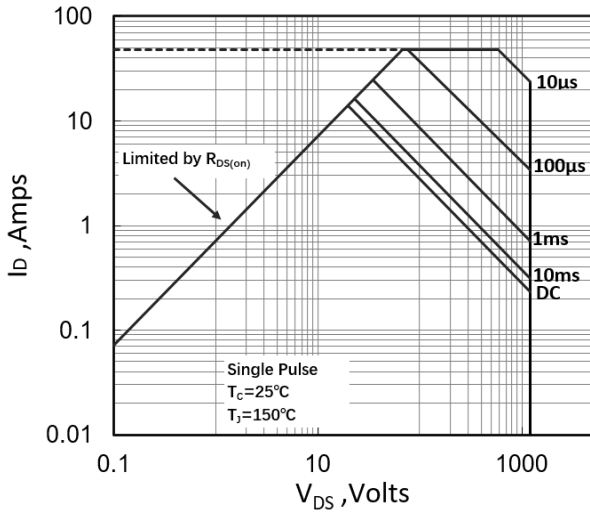

Figure 9. Maximum Safe Operating Area (TO-247)

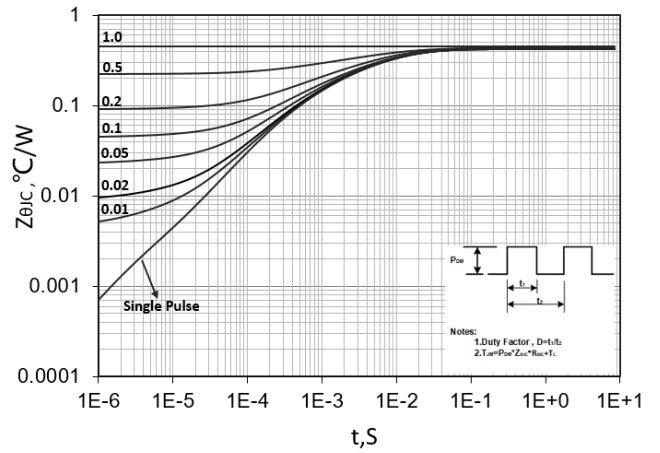

Figure 10. Transient Thermal Response Curve (TO-247)

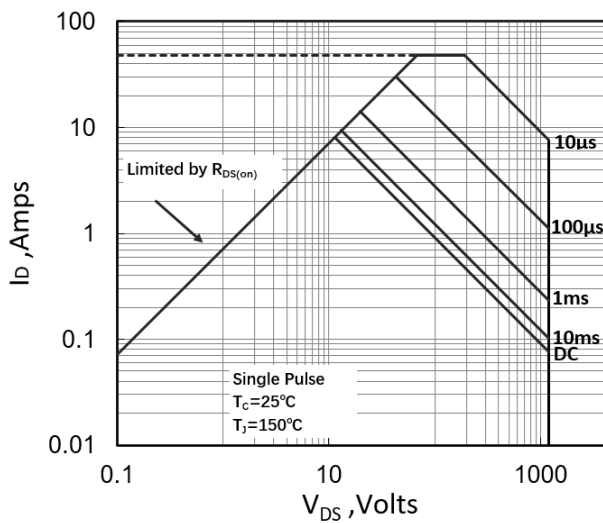

Figure 11. Maximum Safe Operating Area (TO-3PF)

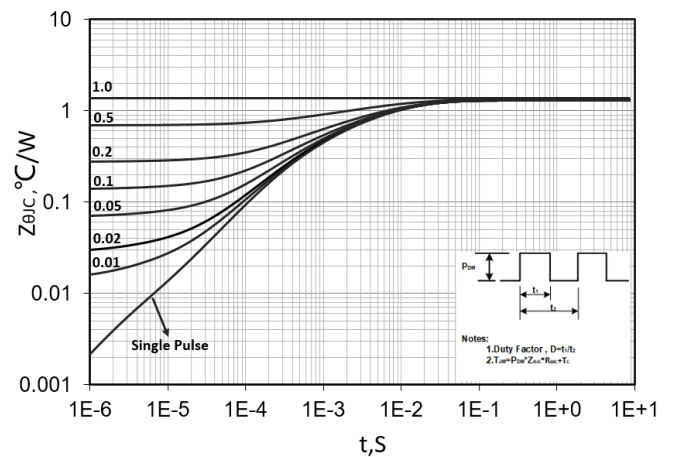
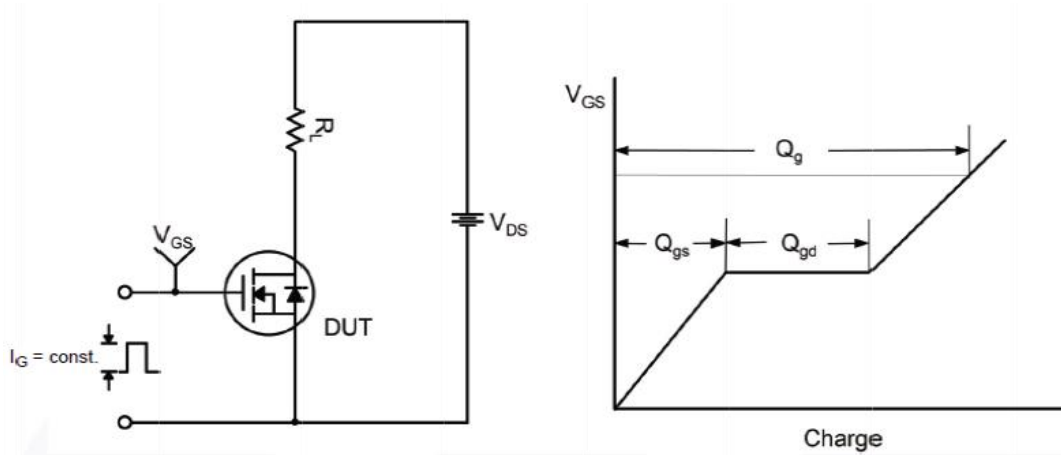
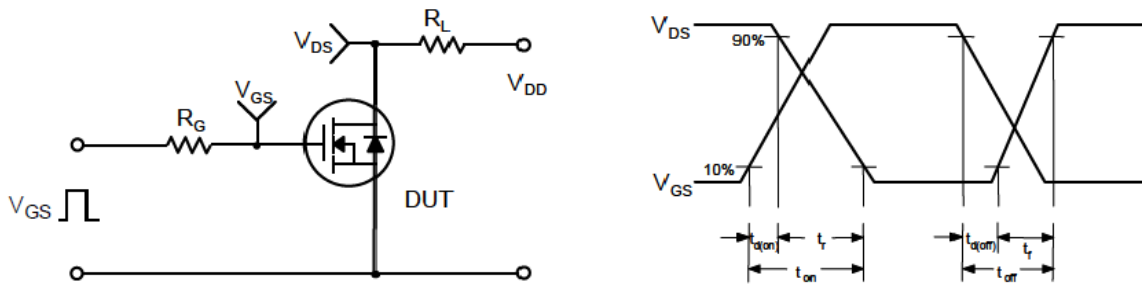

Figure 12. Transient Thermal Response Curve (TO-3PF)

Gate Charge Test Circuit & Waveform



Switching Test Circuit & Waveforms



Unclamped Inductive Switching Test Circuit & Waveforms

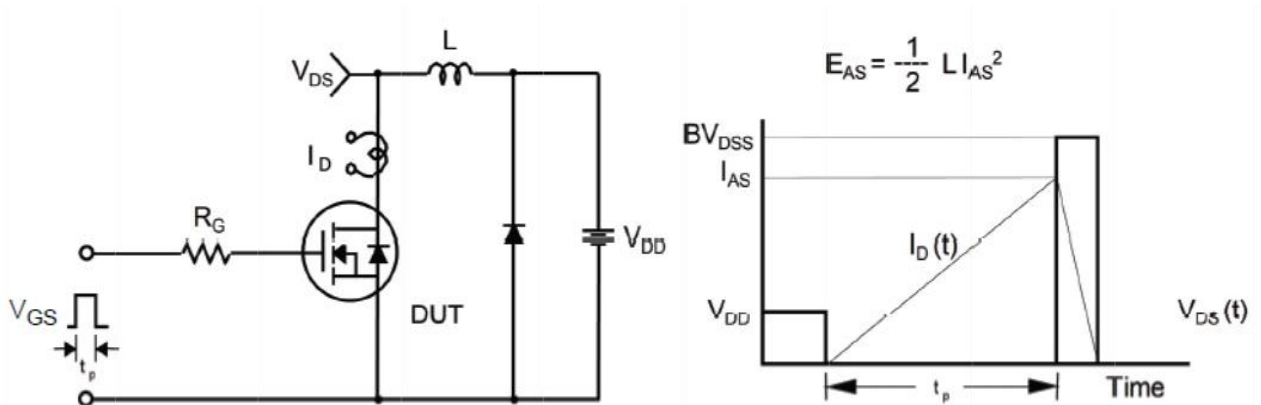

Mechanical Dimensions for TO-247

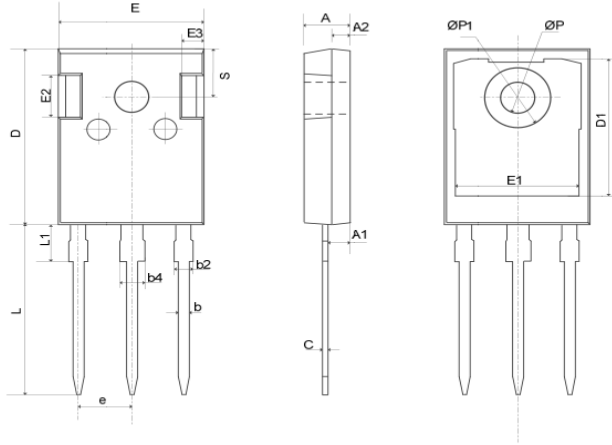

COMMON DIMENSIONS

SYMBOL	MM	
	MIN	MAX
A	4.80	5.20
A1	2.21	2.61
A2	1.85	2.15
b	1.11	1.36
b2	1.91	2.21
b4	2.91	3.21
c	0.51	0.75
D	20.70	21.30
D1	16.25	16.85
E	15.50	16.10
E1	13.00	13.60
E2	4.80	5.20
E3	2.30	2.70
e	5.44BSC	
L	19.62	20.22
L1	—	4.30
ØP	3.40	3.80
ØP1	—	7.30
S	6.15BSC	

Mechanical Dimensions for TO-3PF

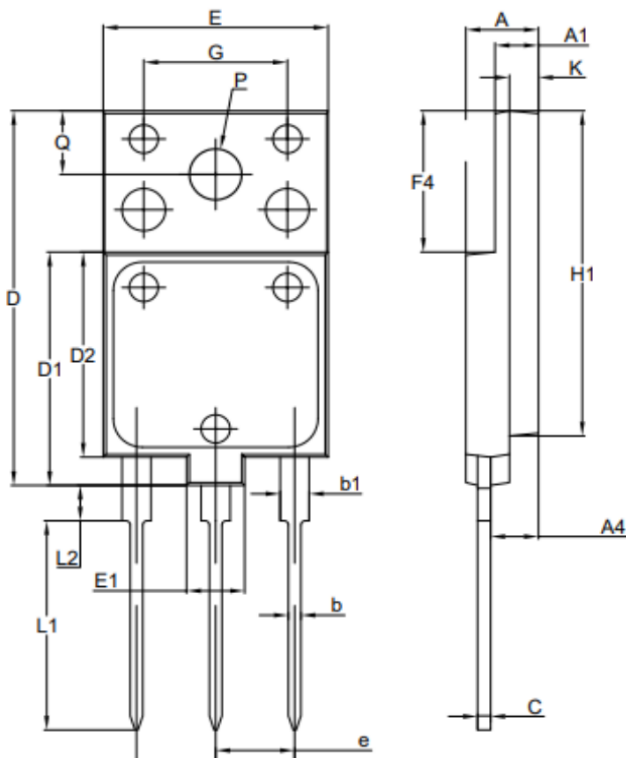

COMMON DIMENSIONS

SYMBOL	MM		
	MIN	NOM	MAX
A	5.3	5.5	5.7
A1	2.8	3	3.2
b	0.66	0.86	1.06
b1	1.8	2	2.2
A4	3.1	3.3	3.5
C	0.8	0.9	1
D	26.3	26.5	26.7
D1	16.3	16.5	16.7
D2	14.3	14.5	14.7
P	3.4	3.6	3.8
E	15.3	15.5	15.7
E1	3.8	4	4.2
e	5.15	5.45	5.75
G	9.7	9.9	10.1
Q	4.35	4.5	4.65
L1	14.6	14.8	15
L2	2.3	2.5	2.7
K	1.8	2	2.2
F4	9.8	10	10.2
H1	22.8	23	23.2
K	1.8	2	2.2

Ordering Information

Part	Package	Marking	Packing method
WMJ12N120D1	TO-247	WMJ12N120D1	Tube
WMX12N120D1	TO-3PF	WMX12N120D1	Tube

Contact Information

No.1001, Shiwan(7) Road, Pudong District, Shanghai, P.R.China.201202

Tel: 86-21-50310888 Fax: 86-21-50757680 Email: market@way-on.com

WAYON website: <http://www.way-on.com>

For additional information, please contact your local Sales Representative.

 is registered trademarks of Wayon Corporation.

Disclaimer

WAYON reserves the right to make changes without further notice to any Products herein to improve reliability, function, or design. The Products are not designed for use in hostile environments, including, without limitation, aircraft, nuclear power generation, medical appliances, and devices or systems in which malfunction of any Product can reasonably be expected to result in a personal injury. The information given in this document shall in no event be regarded as a guarantee of conditions or characteristics. WAYON does not assume any liability for infringement of patents, copyrights, or other intellectual property rights of third parties by or arising from the use of Products or technical information described in this document.