

Features

- Way-on Small Signal MOSFETs
- $V_{DS} = 60V$, $I_D = 3A$
 $R_{DS(on)} < 83m\Omega @ V_{GS} = 10V$
 $R_{DS(on)} < 90m\Omega @ V_{GS} = 4.5V$
- Trench LV MOSFET Technology

Mechanical Characteristics

- SOT-23 Package
- Marking : Making Code
- RoHS Compliant

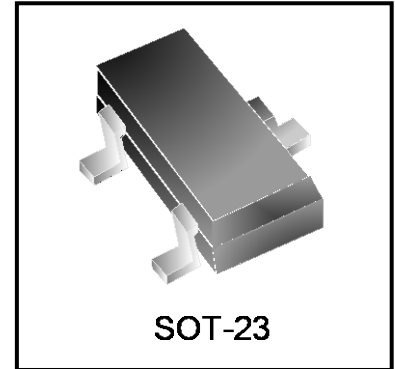

Schematic & PIN Configuration

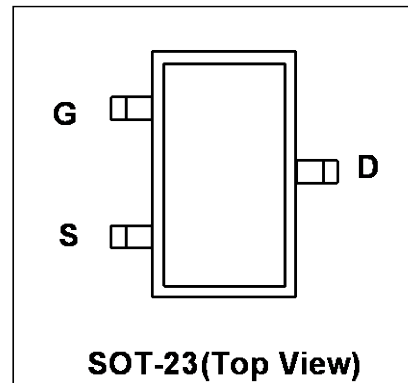
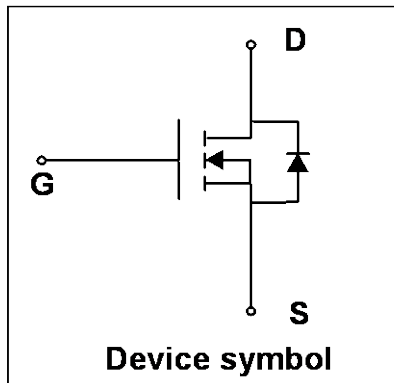

Absolute Maximum Rating ($T_A=25^\circ C$ unless otherwise noted)

Parameter	Symbol	Value	Unit
Drain-Source Voltage	V_{DS}	60	V
Gate-Source Voltage	V_{GS}	± 20	V
Continuous Drain Current	I_D	3	A
Pulsed Drain Current ¹	I_{DM}	12	A
Power Dissipation	P_D	1.5	W
Operating Junction and Storage Temperature Range	T_J, T_{STG}	-55 to 150	$^\circ C$

Thermal Characteristics

Parameter	Symbol	Value	Unit
Thermal Resistance from Junction-to-Ambient ²	$R_{\theta JA}$	83.3	$^\circ C/W$

Electrical Characteristics ($T_J=25^{\circ}\text{C}$ unless otherwise noted)

Parameter	Symbol	Test Condition	Min.	Typ.	Max.	Unit
Static Characteristics						
Drain-Source Breakdown Voltage	$V_{(BR)DSS}$	$V_{GS} = 0\text{ V}, I_D = 250\mu\text{A}$	60	-	-	V
Zero Gate Voltage Drain Current	I_{DSS}	$V_{DS} = 60\text{V}, V_{GS} = 0\text{V}$	-	-	1	μA
Gate-body Leakage Current	I_{GSS}	$V_{DS} = 0\text{ V}, V_{GS} = \pm 20\text{V}$	-	-	± 100	nA
Gate Threshold Voltage	$V_{GS(th)}$	$V_{DS} = V_{GS}, I_D = 250\mu\text{A}$	1.2	1.7	2.2	V
Drain-Source On-state Resistance ³	$R_{DS(on)}$	$V_{GS} = 10\text{V}, I_D = 2\text{A}$	-	67	83	m Ω
		$V_{GS} = 4.5\text{V}, I_D = 1\text{A}$	-	75	90	
Dynamic Characteristics⁴						
Input Capacitance	C_{iss}	$V_{GS} = 0\text{V}, V_{DS} = 30\text{V}, f = 1\text{MHz}$	-	635	-	pF
Output Capacitance	C_{oss}		-	26	-	
Reverse Transfer Capacitance	C_{rss}		-	20	-	
Switching Characteristics⁴						
Total Gate Charge	Q_g	$V_{GS} = 10\text{V}, V_{DS} = 30\text{V}, I_D = 3\text{A}$	-	11.3	-	nC
Gate-Source Charge	Q_{gs}		-	1.7	-	
Gate-Drain Charge	Q_{gd}		-	1.6	-	
Turn-on Delay Time	$t_{d(on)}$	$V_{GS} = 10\text{V}, V_{DD} = 30\text{V}, I_D = 3\text{A}, R_G = 3\Omega$	-	1.6	-	ns
Turn-on Rise Time	t_r		-	2.5	-	
Turn-off Delay Time	$t_{d(off)}$		-	13.4	-	
Turn- off Fall Time	t_f		-	2.6	-	
Source-Drain Diode characteristics						
Body Diode Voltage ³	V_{SD}	$I_S = 1\text{A}, V_{GS} = 0\text{V}$	-	-	1.2	V
Continuous Source Current	I_S		-	-	3	A

Notes:

1. Repetitive rating, pulse width limited by junction temperature $T_{J(MAX)}=150^{\circ}\text{C}$.
2. The data tested by surface mounted on a 1 inch² FR-4 board with 20Z copper, The value in any given application depends on the user's specific board design.
3. Pulse Test: Pulse width $\leq 300\mu\text{s}$, duty cycle $\leq 2\%$.
4. This value is guaranteed by design hence it is not included in the production test.

Typical Characteristics

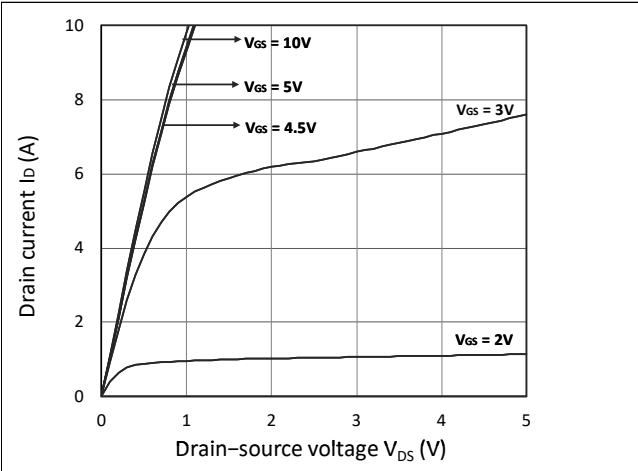

Figure 1. Output Characteristics

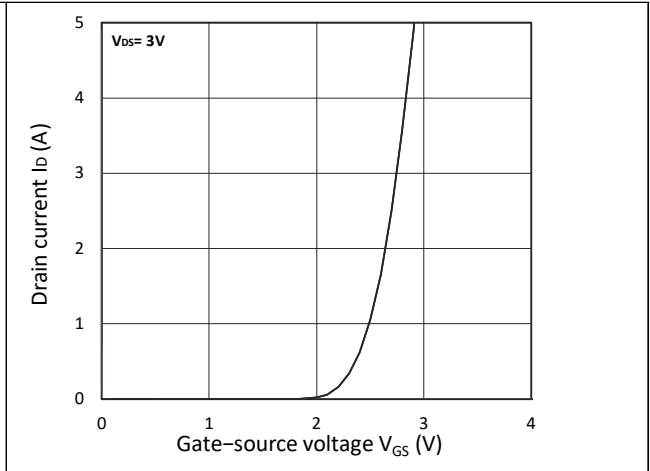

Figure 2. Transfer Characteristics

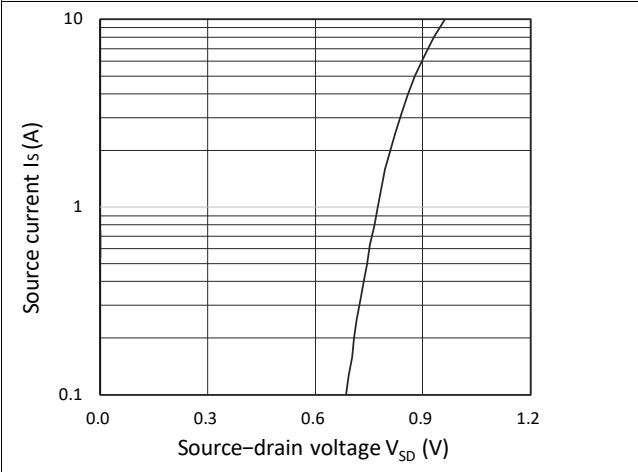

Figure 3. Forward Characteristics of Reverse

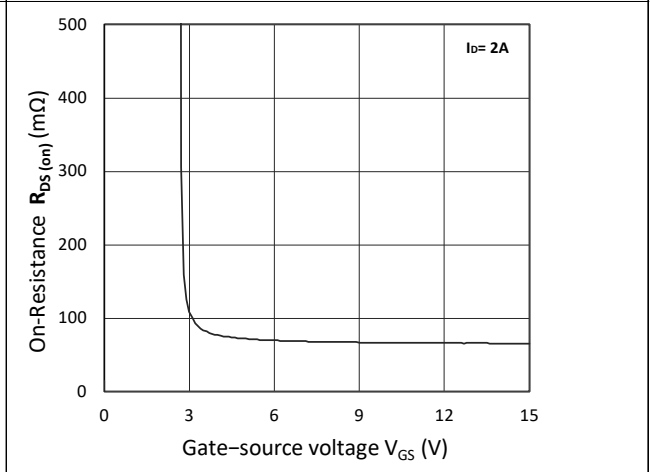

Figure 4. $R_{DS(ON)}$ vs. V_{GS}

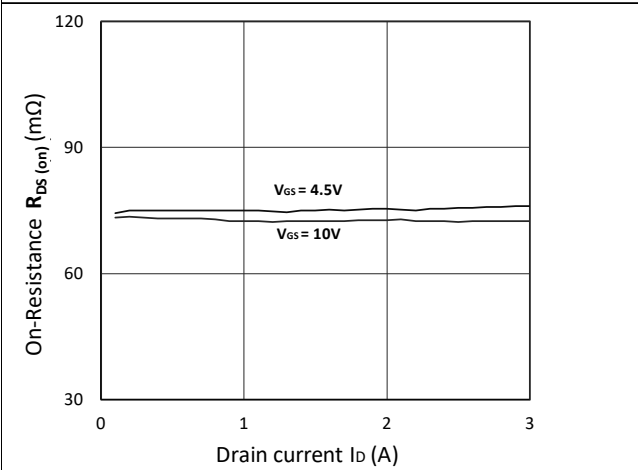

Figure 5. $R_{DS(ON)}$ vs. I_D

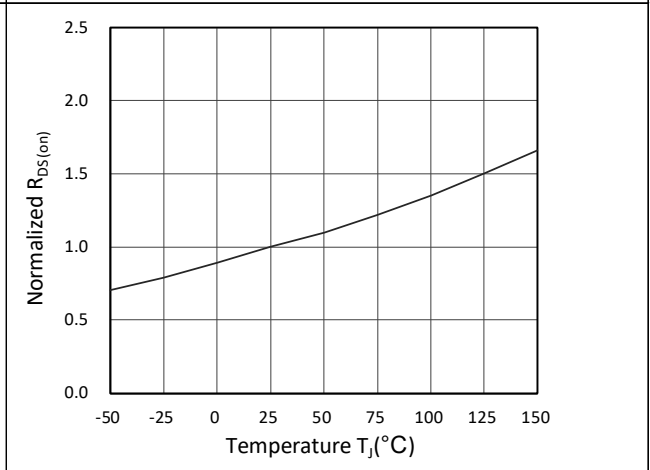

Figure 6. Normalized $R_{DS(ON)}$ vs. Temperature

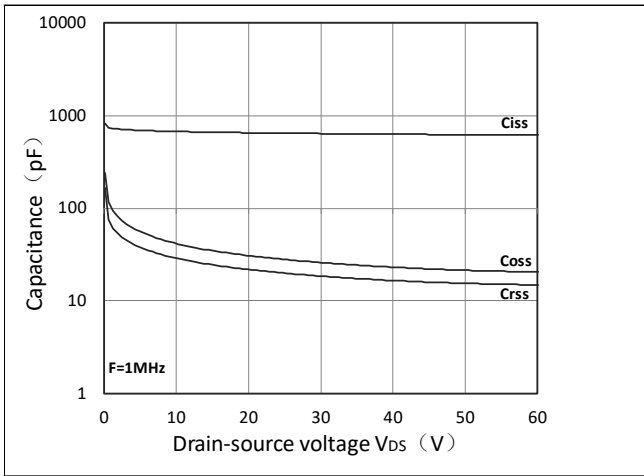

Figure 7. Capacitance Characteristics

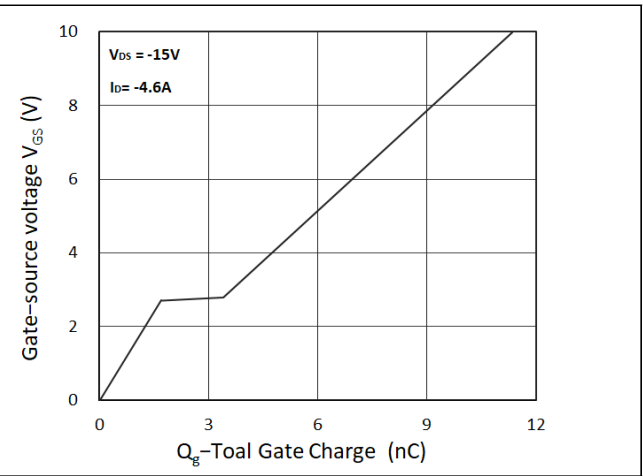
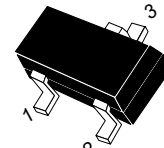
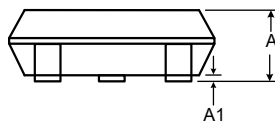
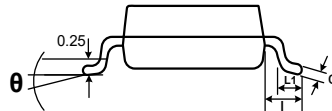
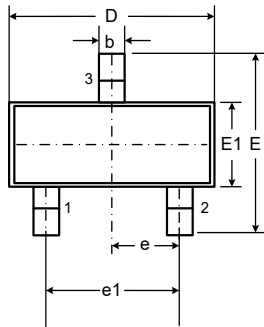

Figure 8. Gate Charge Characteristics

Outline Drawing – SOT-23

PACKAGE OUTLINE



SOT-23

DIMENSIONS

SYMBOL	MILLIMETER		INCHES	
	MIN	MAX	MIN	MAX
A	0.90	1.15	0.035	0.045
A1	0.00	0.10	0.000	0.004
b	0.30	0.50	0.012	0.020
c	0.08	0.15	0.003	0.006
D	2.80	3.00	0.110	0.118
E	2.25	2.55	0.089	0.100
E1	1.20	1.40	0.047	0.055
e	0.95 BSC		0.037BSC	
e1	1.80	2.00	0.071	0.079
L	0.55REF		0.022REF	
L1	0.30	0.50	0.012	0.020
θ	0°	8°	0°	8°

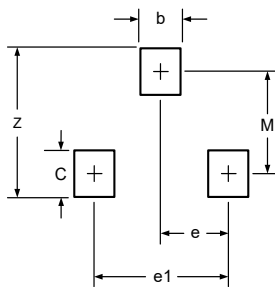

DIMENSIONS		
DIM	INCHES	MILLIMETERS
M	0.080	2.02
C	0.032	0.80
Z	0.111	2.82
e	0.037 BSC	0.95 BSC
e1	0.075 BSC	1.90 BSC
b	0.032	0.80

Notes

1. Dimensioning and tolerances per ANSI Y14.5M, 1985.
2. Controlling Dimension: Inches
3. Pin 3 is the cathode (Unidirectional Only).
4. Dimensions are exclusive of mold flash and metal burrs.

Marking Codes

Part Number	WM06N30MS
Marking Code	

Package Information

Qty: 3k/Reel

CONTACT INFORMATION

No.1001, Shiwan (7) Road, Pudong District, Shanghai, P.R.China.201207

Tel: 86-21-68969993 Fax: 86-21-50757680 Email: market@way-on.com

WAYON website: <http://www.way-on.com>

For additional information, please contact your local Sales Representative.

WAYON® is registered trademark of Wayon Corporation.

Specifications are subject to change without notice.

The device characteristics and parameters in this data sheet can and do vary in different applications and actual device performance may vary over time. Users should verify actual device performance in their specific applications.