

Features

- Way-on Small Signal MOSFETs
- $V_{DS} = 60V$, $I_D = 0.34A$
 $R_{DS(on)} < 2\Omega @ V_{GS} = 10V$
 $R_{DS(on)} < 2.5\Omega @ V_{GS} = 4.5V$
- Trench LV MOSFET Technology
- ESD Protected

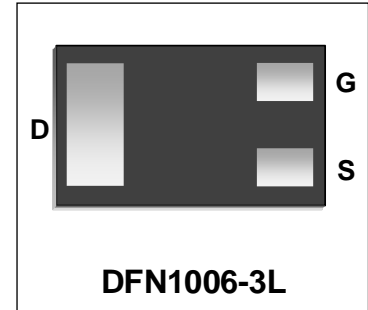

Mechanical Characteristics

- DFN1006-3L Package
- Marking : Making Code
- RoHS Compliant

Schematic & PIN Configuration

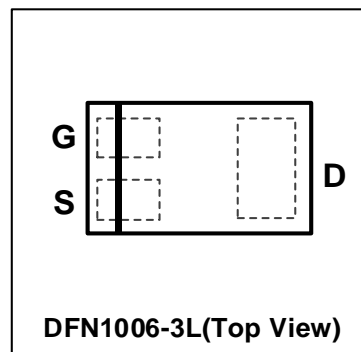
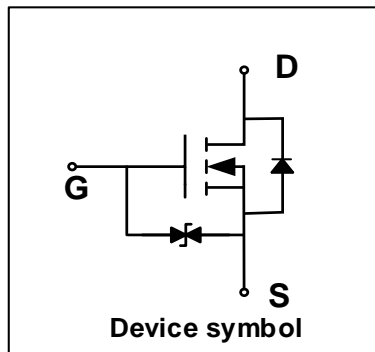

Absolute Maximum Rating ($T_A=25^\circ C$ unless otherwise noted)

Parameter	Symbol	Value	Unit
Drain-Source Voltage	V_{DS}	60	V
Gate-Source Voltage	V_{GS}	± 20	V
Continuous Drain Current	I_D	0.34	A
Pulsed Drain Current ¹	I_{DM}	1.36	A
Power Dissipation	P_D	350	mW
Operating Junction and Storage Temperature Range	T_J, T_{STG}	-55 to 150	$^\circ C$

Thermal Characteristics

Parameter	Symbol	Value	Unit
Thermal Resistance from Junction to Ambient ²	$R_{\theta JA}$	357	$^\circ C/W$

Electrical Characteristics (T_J=25°C unless otherwise noted)

Parameter	Symbol	Test Condition	Min.	Typ.	Max.	Unit
Static Characteristics						
Drain-Source Breakdown Voltage	V _{(BR)DSS}	V _{GS} = 0V, I _D = 250μA	60	-	-	V
Gate leakage Current	I _{GSS}	V _{GS} = ±20V, V _{DS} = 0V	-	-	±10	μA
Drain Cut-off Current	I _{DSS}	V _{DS} = 60V, V _{GS} = 0V	-	-	1	μA
Gate Threshold Voltage	V _{GS(th)}	V _{DS} = V _{GS} , I _D = 250μA	1	1.4	2	V
Drain-Source On-state Resistance ³	R _{DS(on)}	V _{GS} = 10V, I _D = 0.3A	-	1.3	2	Ω
		V _{GS} = 4.5V, I _D = 0.2A	-	1.4	2.5	Ω
Dynamic characteristics⁴						
Input Capacitance	C _{iss}	V _{DS} = 30V, V _{GS} = 0V, f = 1MHz	-	25	-	pF
Output Capacitance	C _{oss}		-	5.6	-	
Reverse Transfer Capacitance	C _{rss}		-	2.2	-	
Switching Characteristics⁴						
Total Gate Charge	Q _g	V _{GS} = 4.5V, V _{DS} = 30V, I _D = 0.3A	-	0.61	-	nC
Gate-Source Charge	Q _{gs}		-	0.27	-	
Gate-Drain Charge	Q _{gd}		-	0.23	-	
Turn-on Delay Time	t _{d(on)}	V _{GS} = 10V, V _{DD} = 30V, I _D = 0.3A, R _G = 3Ω	-	4.3	-	ns
Turn-on Rise Time	t _r		-	2.4	-	
Turn-off Delay Time	t _{d(off)}		-	21	-	
Turn- off Fall Time	t _f		-	14.5	-	
Source-Drain Diode characteristics						
Diode Forward Voltage ³	V _{SD}	I _S = 0.3A , V _{GS} =0V,	-	-	1.5	V
Continuous Source Current	I _S	-	-	-	0.34	A

Notes:

1. Repetitive rating, pulse width limited by junction temperature T_{J(MAX)}=150°C.
2. The data tested by surface mounted on a 1 inch² FR-4 board with 2OZ copper, The value in any given application depends on the user's specific board design.
3. Pulse Test: Pulse width≤300μs, duty cycle≤2%.
4. This value is guaranteed by design hence it is not included in the production test.

Typical Characteristics

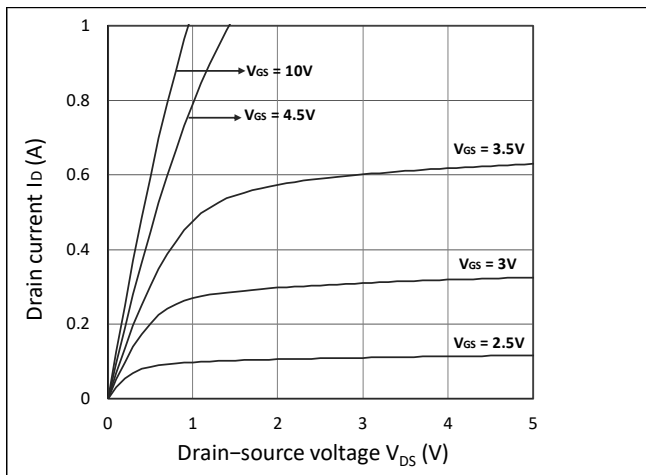

Figure 1. Output Characteristics

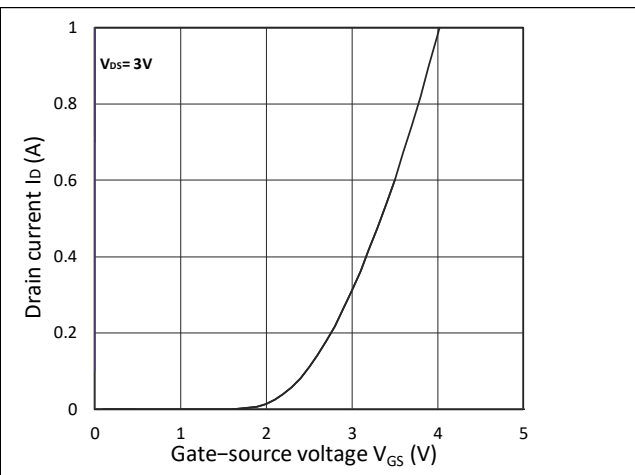

Figure 2. Transfer Characteristics

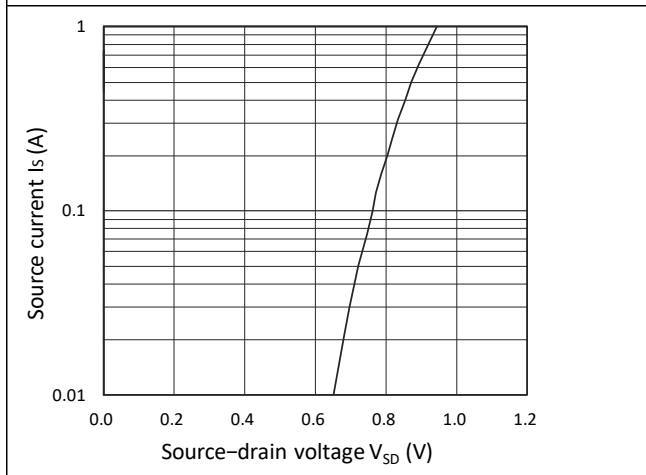

Figure 3. Forward Characteristics of Reverse

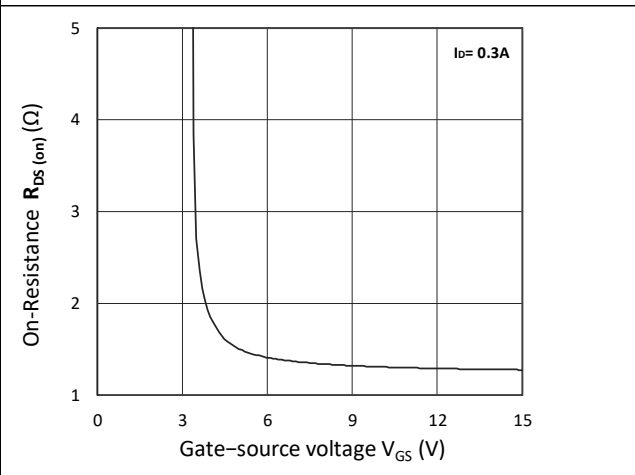

Figure 4. $R_{DS(ON)}$ vs. V_{GS}

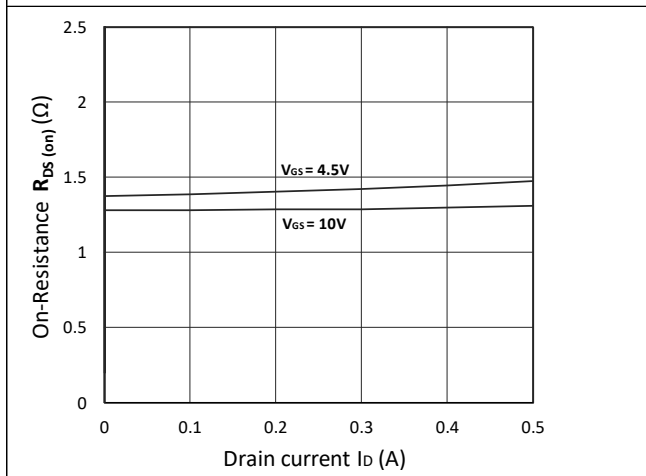

Figure 5. $R_{DS(ON)}$ vs. I_D

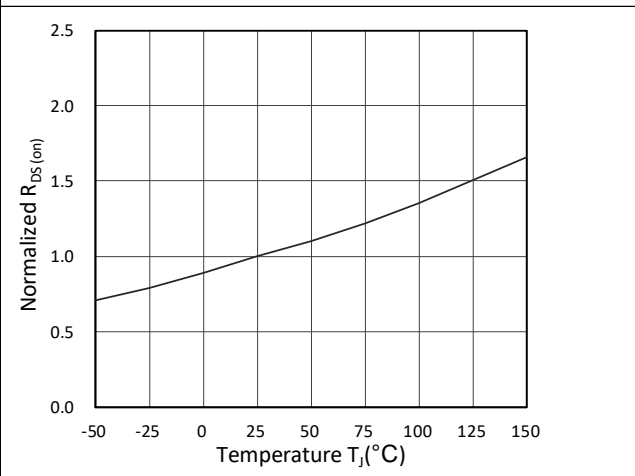

Figure 6. Normalized $R_{DS(ON)}$ vs. Temperature

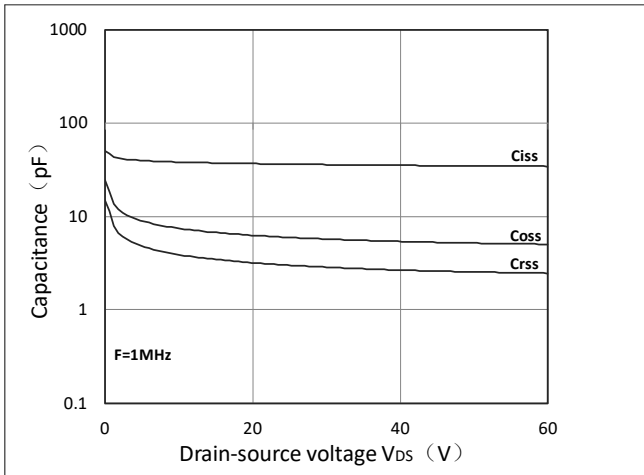

Figure 7. Capacitance Characteristics

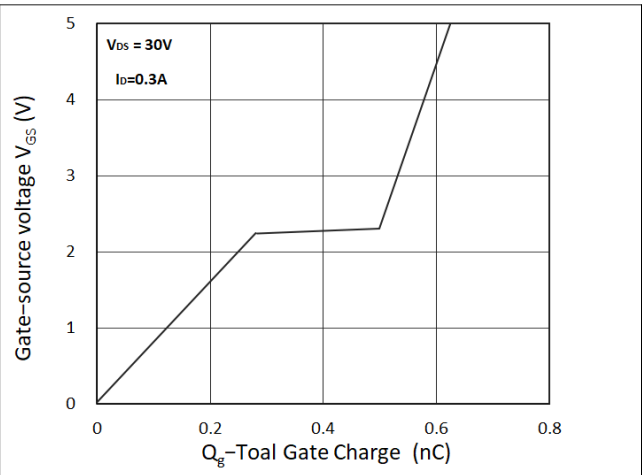
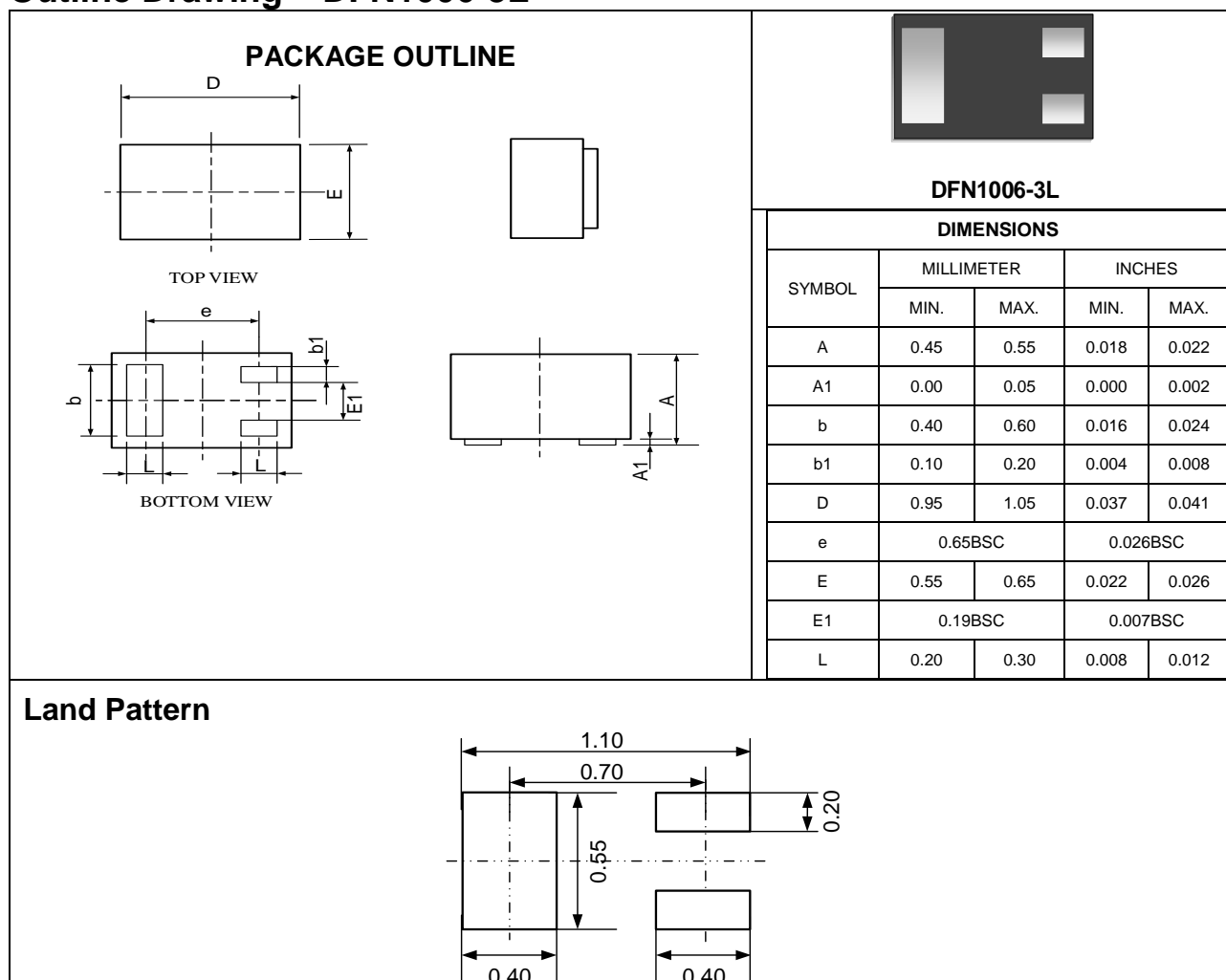

Figure 8. Gate Charge Characteristics

Outline Drawing – DFN1006-3L



Marking Codes

Part Number	WM06N03FE
Marking Code	

Package Information

Qty: 10k/Reel

CONTACT INFORMATION

No.1001, Shiwan (7) Road, Pudong District, Shanghai, P.R.China.201207

Tel: 86-21-68969993 Fax: 86-21-50757680 Email: market@way-on.com

WAYON website: <http://www.way-on.com>

For additional information, please contact your local Sales Representative.

WAYON® is registered trademark of Wayon Corporation.

Specifications are subject to change without notice.

The device characteristics and parameters in this data sheet can and do vary in different applications and actual device performance may vary over time. Users should verify actual device performance in their specific applications.