

## N-Channel Enhancement MOSFET

### Features

- Way-on Small Signal MOSFETs
- $V_{DS} = 20V$ ,  $I_D = 2.5A$   
 $R_{DS(on)} < 80m\Omega @ V_{GS} = 4.5V$   
 $R_{DS(on)} < 120m\Omega @ V_{GS} = 2.5V$
- Trench LV MOSFET Technology

### Mechanical Characteristics

- SOT-23 Package
- Marking : Making Code
- RoHS Compliant

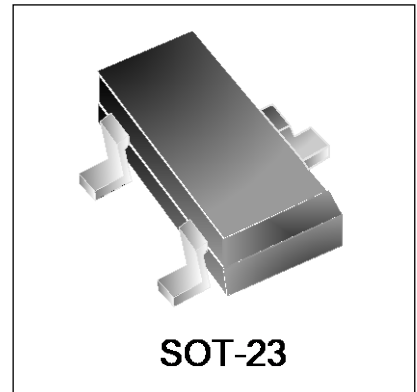

### Schematic & PIN Configuration

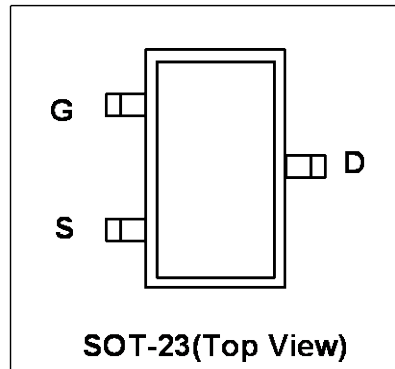
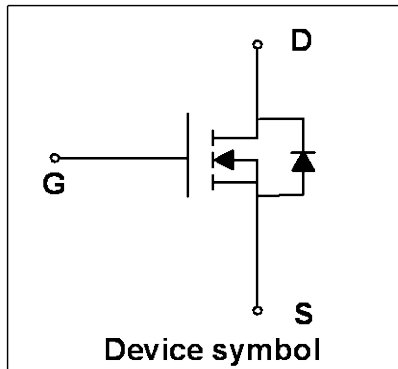

### Absolute Maximum Rating ( $T_A=25^\circ C$ unless otherwise noted)

Parameter	Symbol	Value	Unit
Drain-Source Voltage	$V_{DS}$	20	V
Gate-Source Voltage	$V_{GS}$	$\pm 12$	V
Continuous Drain Current	$I_D$	2.5	A
Pulsed Drain Current <sup>1</sup>	$I_{DM}$	10	A
Power Dissipation	$P_D$	450	mW
Operating Junction and Storage Temperature Range	$T_J, T_{STG}$	-55 to 150	$^\circ C$

### Thermal Characteristics

Parameter	Symbol	Value	Unit
Thermal Resistance from Junction to Ambient <sup>2</sup>	$R_{\theta JA}$	278	$^\circ C/W$

**Electrical Characteristics** ( $T_J=25^\circ\text{C}$  unless otherwise noted)

Parameter	Symbol	Test Condition	Min.	Typ.	Max.	Unit
<b>Static Characteristics</b>						
Drain-Source Breakdown Voltage	$BV_{DSS}$	$V_{GS}=0V, I_D=250\mu A$	20	-	-	V
Gate leakage Current	$I_{GSS}$	$V_{GS}=\pm 12V, V_{DS}=0V$	-	-	$\pm 100$	nA
Drain Cut-off Current	$I_{DSS}$	$V_{DS}=20V, V_{GS}=0V$	-	-	1	$\mu A$
Gate Threshold Voltage	$V_{GS(th)}$	$V_{DS}=V_{GS}, I_D=250\mu A$	0.4	0.65	1	V
Drain-Source On-state Resistance <sup>3</sup>	$R_{DS(on)}$	$V_{GS}=4.5V, I_D=2.5A$	-	54	80	m $\Omega$
		$V_{GS}=2.5V, I_D=2A$	-	76	120	
		$V_{GS}=1.8V, I_D=2A$	-	136	200	
<b>Dynamic characteristics<sup>4</sup></b>						
Input Capacitance	$C_{iss}$	$V_{GS}=0V, V_{DS}=10V,$ $f=1MHz$	-	125	-	pF
Output Capacitance	$C_{oss}$		-	26	-	
Reverse Transfer Capacitance	$C_{rss}$		-	20	-	
<b>Switching Characteristics<sup>4</sup></b>						
Total Gate Charge	$Q_g$	$V_{GS}=4.5V, V_{DS}=10V,$ $I_D=2.5A$	-	5.5	-	nC
Gate-Source Charge	$Q_{gs}$		-	0.6	-	
Gate-Drain Charge	$Q_{gd}$		-	1.3	-	
Turn-on Delay Time	$t_{d(on)}$	$V_{GS}=4.5V, V_{DD}=10V,$ $I_D=2.5A, R_G=3\Omega$	-	9.6	-	ns
Turn-on Rise Time	$t_r$		-	15.8	-	
Turn-off Delay Time	$t_{d(off)}$		-	27.4	-	
Turn- off Fall Time	$t_f$		-	7.8	-	
<b>Source-Drain Diode characteristics</b>						
Diode Forward Voltage <sup>3</sup>	$V_{SD}$	$I_S=2.5A, V_{GS}=0V$	-	-	1.2	V
Continuous Source Current	$I_S$		-	-	2.5	A

**Notes:**

1. Repetitive rating, pulse width limited by junction temperature  $T_{J(MAX)}=150^\circ\text{C}$ .
2. The data tested by surface mounted on a 1 inch2 FR-4 board with 20Z copper, The value in any given application depends on the user's specific board design.
3. Pulse Test: Pulse width $\leq 300\mu s$ , duty cycle $\leq 2\%$ .
4. This value is guaranteed by design hence it is not included in the production test.

### Typical Characteristics

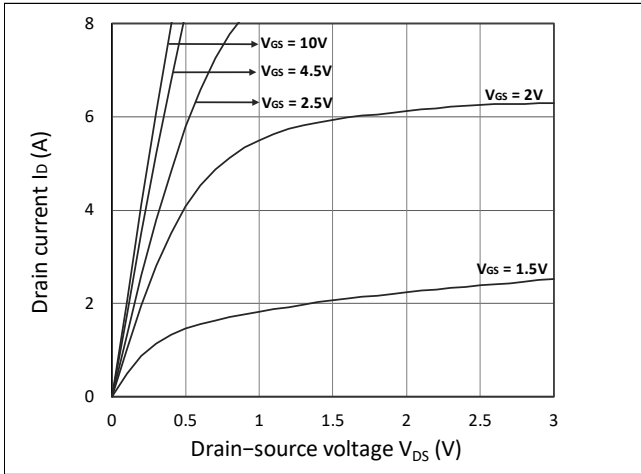

Figure 1. Output Characteristics

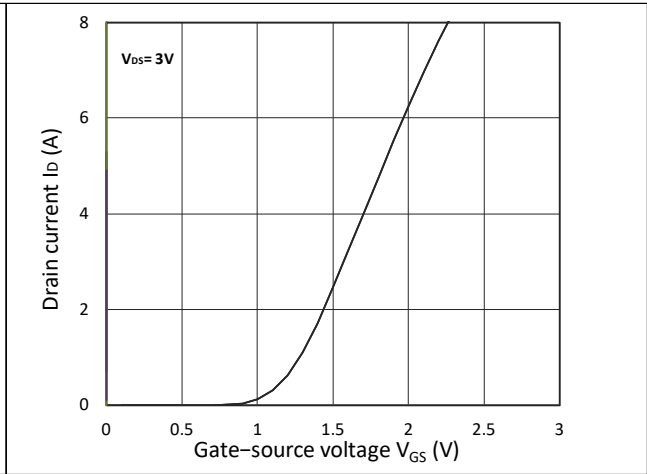

Figure 2. Transfer Characteristics

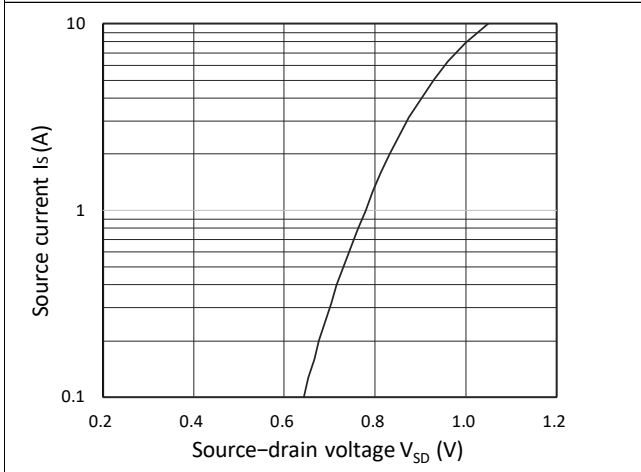

Figure 3. Forward Characteristics of Reverse

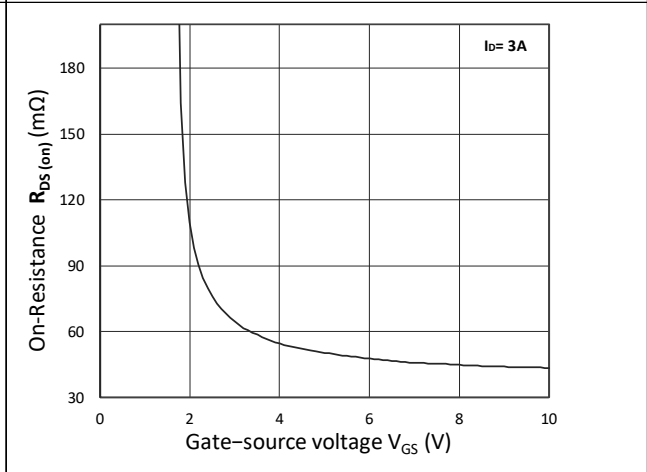

Figure 4.  $R_{DS(ON)}$  vs.  $V_{GS}$

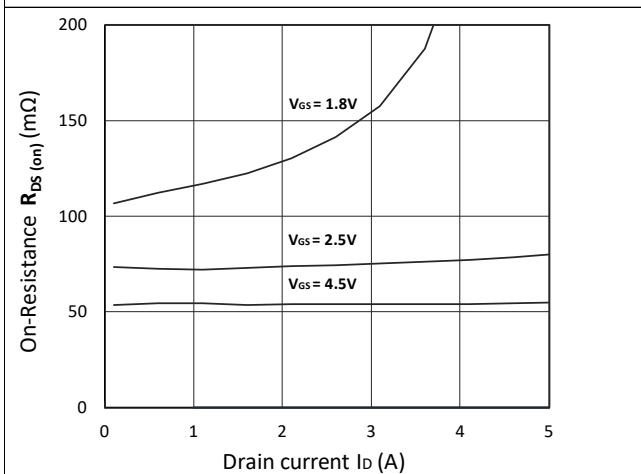

Figure 5.  $R_{DS(ON)}$  vs.  $I_D$

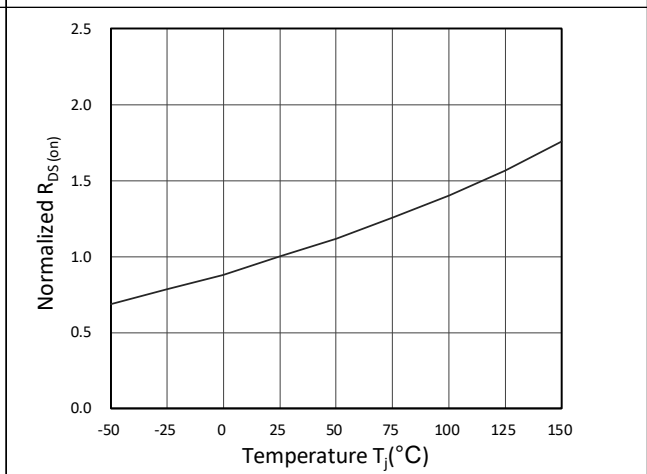

Figure 6. Normalized  $R_{DS(ON)}$  vs. Temperature

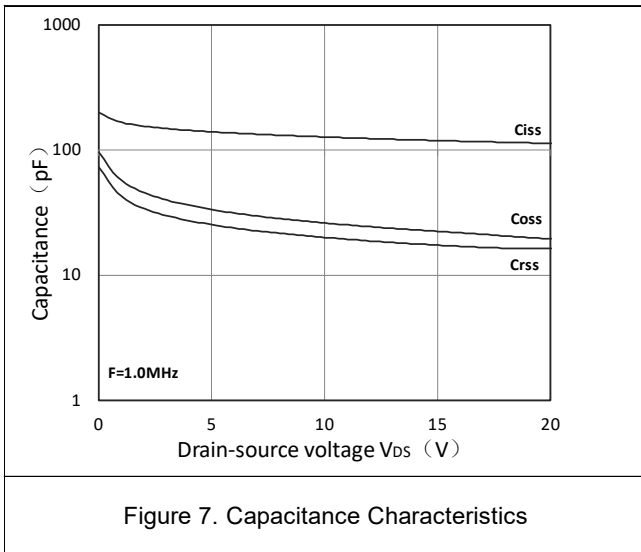

Figure 7. Capacitance Characteristics

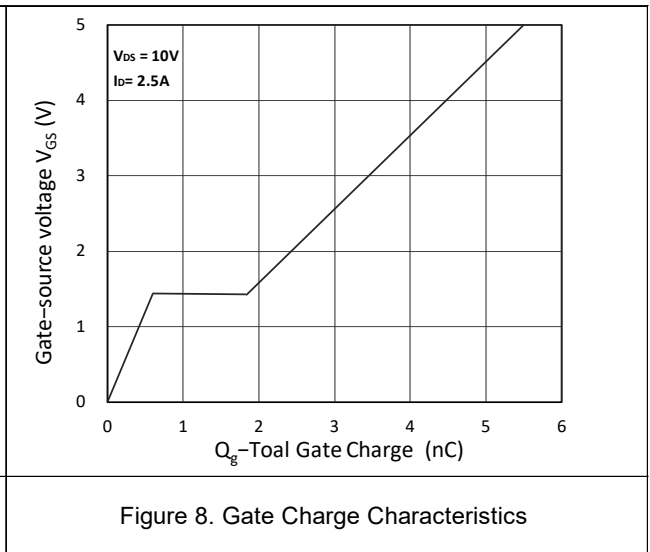
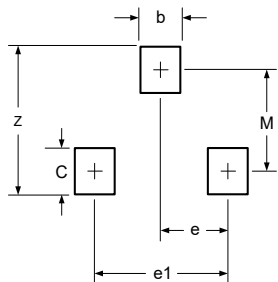
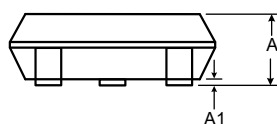
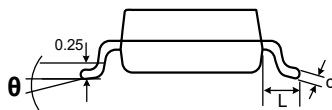
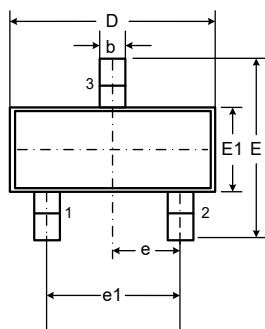

Figure 8. Gate Charge Characteristics

## Outline Drawing – SOT-23

### PACKAGE OUTLINE



DIMENSIONS		
DIM	INCHES	MILLIMETERS
M	0.080	2.02
C	0.032	0.80
Z	0.111	2.82
e	0.037 BSC	0.95 BSC
e1	0.075 BSC	1.90 BSC
b	0.032	0.80

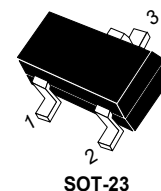

SOT-23

### DIMENSIONS

SYMBOL	MILLIMETER		INCHES	
	MIN	MAX	MIN	MAX
A	0.90	1.15	0.035	0.045
A1	0.00	0.10	0.000	0.004
b	0.30	0.50	0.012	0.020
c	0.08	0.15	0.003	0.006
D	2.80	3.00	0.110	0.118
E	2.25	2.55	0.089	0.100
E1	1.20	1.40	0.047	0.055
e	0.95 BSC		0.037BSC	
e1	1.80	2.00	0.071	0.079
L	0.55REF		0.022REF	
θ	0°	8°	0°	8°

### Notes

1. Dimensioning and tolerances per ANSI Y14.5M, 1985.
2. Controlling Dimension: Inches
3. Pin 3 is the cathode (Unidirectional Only).
4. Dimensions are exclusive of mold flash and metal burrs.

## Marking Codes

Part Number	WM02N25M
Marking Code	

## Package Information

Qty: 3k/Reel

## CONTACT INFORMATION

No.1001, Shiwan (7) Road, Pudong District, Shanghai, P.R.China.201207

Tel: 86-21-68969993 Fax: 86-21-50757680 Email: [market@way-on.com](mailto:market@way-on.com)

WAYON website: <http://www.way-on.com>

For additional information, please contact your local Sales Representative.

**WAYON**® is registered trademark of Wayon Corporation.

*Specifications are subject to change without notice.*

*The device characteristics and parameters in this data sheet can and do vary in different applications and actual device performance may vary over time. Users should verify actual device performance in their specific applications.*