

Dual N-Channel Enhancement Mode MOSFET

Description

WM02DN080C-YW uses advanced power trench technology that has been especially tailored to minimize the on-state resistance. This device is suitable for un-directional or bidirectional load switch, facilitated by its common-drain configuration.

$V_{(BR)DSS}(V)$	$I_D(A)$	$R_{DS(on)TYP}(m\Omega)$
20	8	13.0 @VGS=4.5V
		13.5 @VGS=4.0V
		14.0 @VGS=3.7V
		15.0 @VGS=3.1V
		17.5 @VGS=2.5V

Features

- Super high dense cell for low $R_{DS(on)}$
- RoHS Compliant and Halogen-Free
- ESD protected: Class 2

Applications

- Battery protection
- Load switch

Schematic & PIN Configuration ($T_A=25^\circ C$, unless otherwise noted)

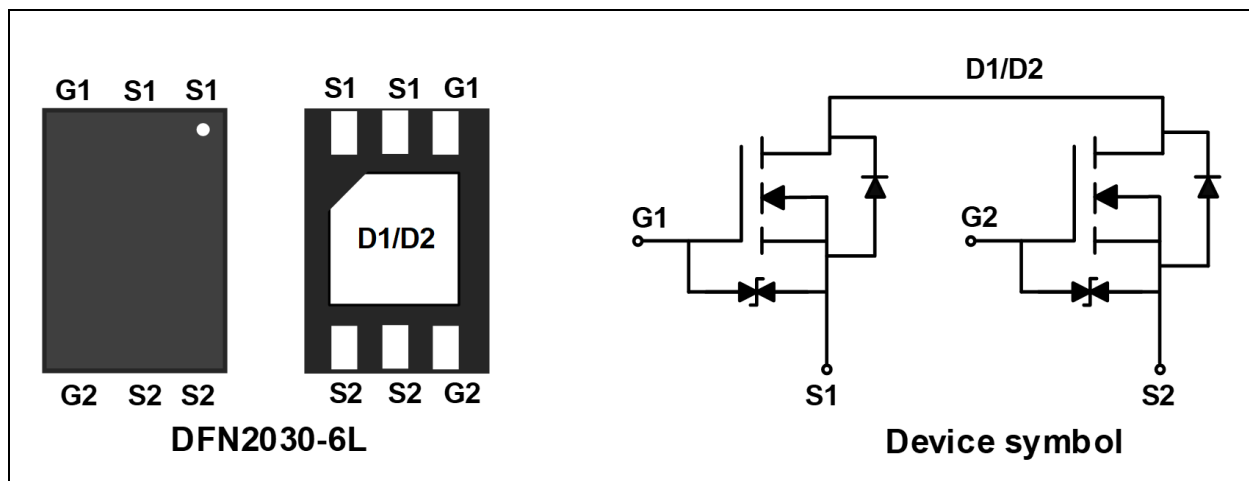

Absolute Maximum Rating

Parameter	Symbol	Value	Unit	
Drain-Source Voltage	V_{DS}	20	V	
Gate-Source Voltage	V_{GS}	± 12	V	
Continuous Drain Current	I_D	$T_A=25^\circ C$	8	A
		$T_A=70^\circ C$	6.3	A
Pulsed Drain Current ¹	I_{DM}	49	A	
Single Pulse Avalanche Energy ²	E_{AS}	18	mJ	
Total Power Dissipation	P_D	1.56	W	
Operating Junction and Storage Temperature Range	T_J, T_{STG}	-55 to 150	$^\circ C$	

Thermal Characteristics

Parameter	Symbol	Value	Unit
Thermal Resistance from Junction-to-Ambient ³	$R_{\theta JA}$	80	$^\circ C/W$

Electrical Characteristics (T_J=25°C unless otherwise noted)

Parameter	Symbol	Test Conditions	Min.	Typ.	Max.	Unit
Static Characteristics						
Drain-Source Breakdown Voltage	V _{(BR)DSS}	V _{GS} = 0V, I _D = 250μA	20	-	-	V
Zero Gate Voltage Drain Current	I _{DSS}	V _{DS} = 20V, V _{GS} = 0V	-	-	1	μA
Gate-Body Leakage current	I _{GSS}	V _{DS} = 0V, V _{GS} = ±8V	-	-	±10	μA
Gate-Threshold Voltage	V _{GS(th)}	V _{DS} = V _{GS} , I _D = 250μA	0.45	-	1.5	V
Drain-Source on-Resistance ⁴	R _{DS(on)}	V _{GS} = 4.5V, I _D = 2A	9.5	13	15.5	mΩ
		V _{GS} = 4.0V, I _D = 2A	10	13.5	16.5	
		V _{GS} = 3.7V, I _D = 2A	10.5	14	17.5	
		V _{GS} = 3.1V, I _D = 2A	11	15	19	
		V _{GS} = 2.5 V, I _D = 2A	13	17.5	24	
Forward Transconductance ⁴	g _{fs}	V _{DS} = 10V, I _D = 4A	-	17	-	S
Dynamic Characteristics⁵						
Input Capacitance	C _{iss}	V _{DS} = 10V, V _{GS} = 0V, f = 1MHz	-	730	-	pF
Output Capacitance	C _{oss}		-	85	-	
Reverse Transfer Capacitance	C _{rss}		-	75	-	
Switching Characteristics⁵						
Total Gate Charge	Q _g	V _{GS} = 4.5V, V _{DS} = 15V, I _D = 2A	-	11	-	nC
Gate-Source Charge	Q _{gs}		-	2.5	-	
Gate-Drain Charge	Q _{gd}		-	4.5	-	
Turn-on Delay Time	t _{d(on)}	V _{GS} = 4.5V, V _{DD} = 15V, R _G = 3Ω, I _D = 2A	-	7.5	-	ns
Rise Time	t _r		-	38	-	
Turn-off Delay Time	t _{d(off)}		-	48.5	-	
Fall Time	t _f		-	15.7	-	
Drain-Source Body Diode Characteristics						
Diode Forward Voltage ⁴	V _{SD}	I _S = 8A, V _{GS} = 0V	-	-	1.2	V
Continuous Source Current	I _S	T _A =25°C	-	-	8	A

Notes:

1. Repetitive rating, pulse width limited by junction temperature T_{J(MAX)}=150°C.
2. The EAS data shows Max. rating . The test condition is V_{DD}=25V, V_{GS}=10V, L=0.1mH, I_{AS}=19A.
3. The data tested by surface mounted on a 1 inch² FR-4 board with 2OZ copper, The value in any given application depends on the user's specific board design.
4. The data tested by pulsed , pulse width ≤ 300us , duty cycle ≤ 2%.
5. This value is guaranteed by design hence it is not included in the production test.

Typical Characteristics

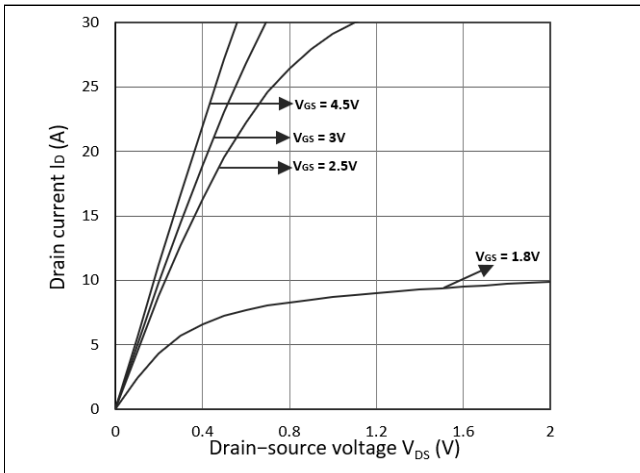

Figure 1. Output Characteristics

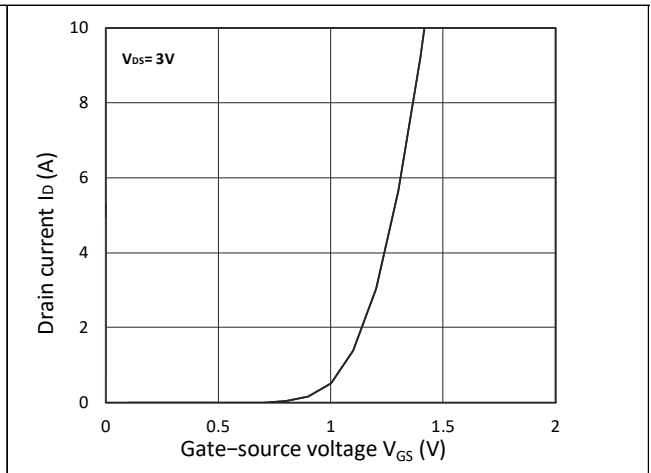

Figure 2. Transfer Characteristics

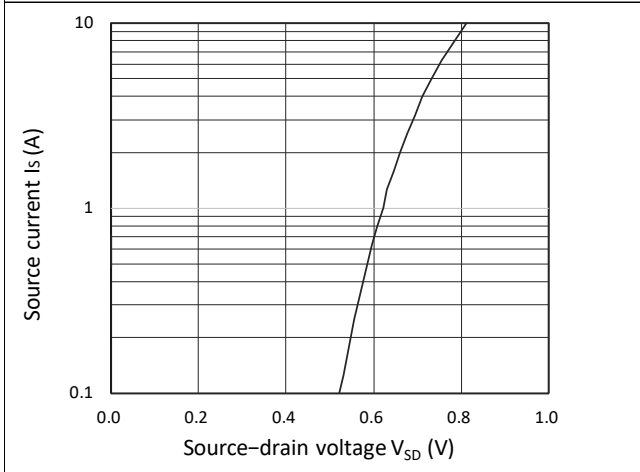

Figure 3. Forward Characteristics of Reverse

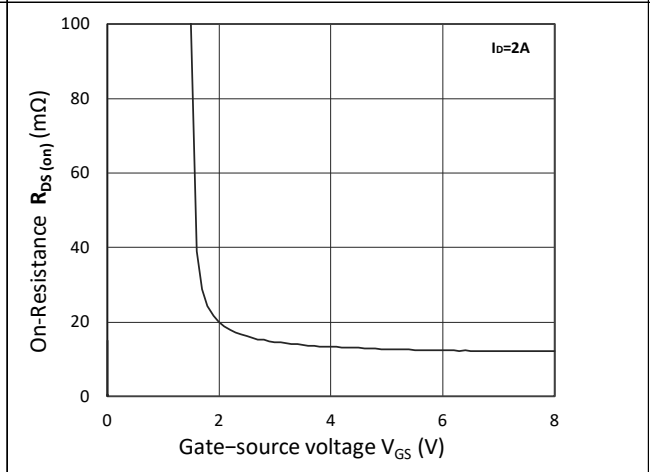

Figure 4. $R_{DS(ON)}$ vs. V_{GS}

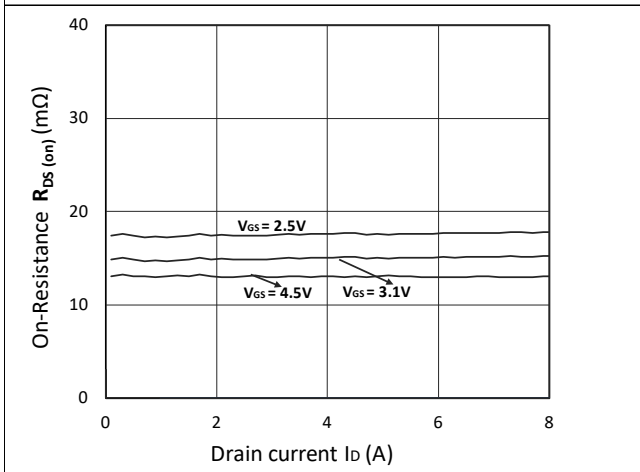

Figure 5. $R_{DS(ON)}$ vs. I_D

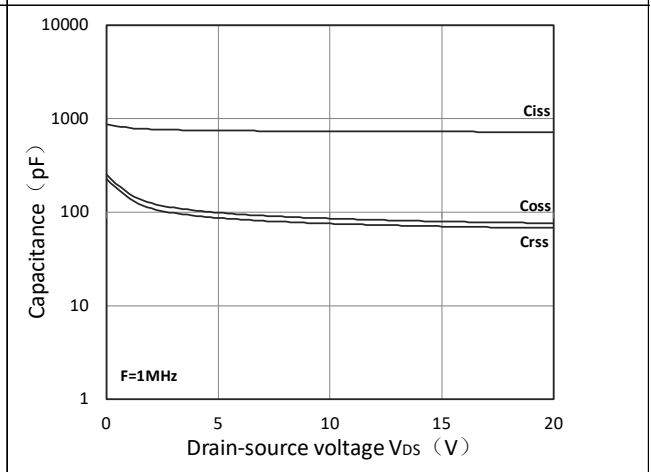
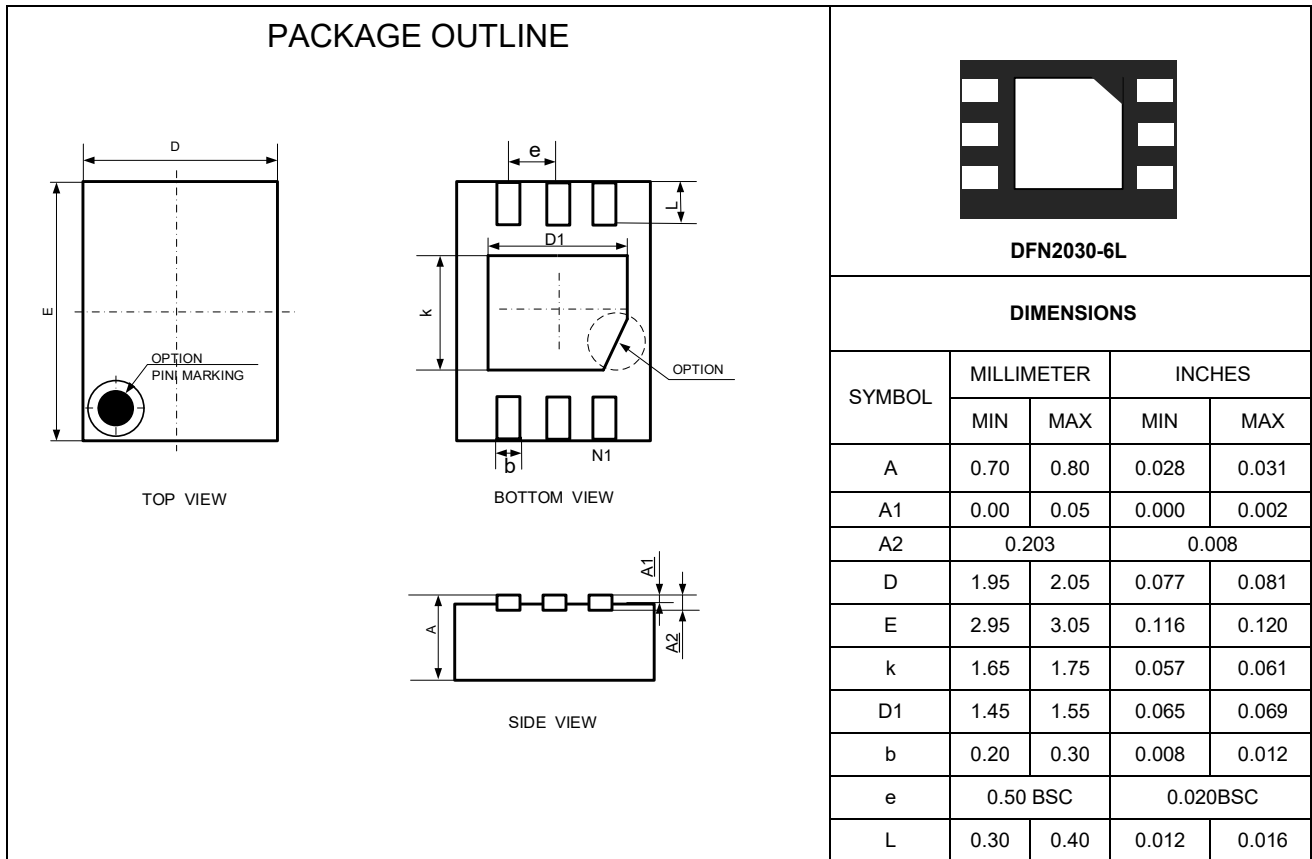
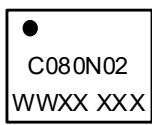

Figure 6. Capacitance Characteristics

Outline Drawing –DFN2030-6L



Marking Codes

Part Number	WM02DN080C	
Marking Code		C080N02 = Device Code WWXX XXX = Date Code

Package Information

Qty: 3k/Reel

CONTACT INFORMATION

No.1001, Shiwan (7) Road, Pudong District, Shanghai, P.R.China.201207

Tel: 86-21-68969993 Fax: 86-21-50757680 Email: market@way-on.com

WAYON website: <http://www.way-on.com>

For additional information, please contact your local Sales Representative.

WAYON® is registered trademark of Wayon Corporation.

Specifications are subject to change without notice.
The device characteristics and parameters in this data sheet can and do vary in different applications and actual device performance may vary over time.
Users should verify actual device performance in their specific applications.