



UZ1084

LINEAR INTEGRATED CIRCUIT

5A ADJUSTABLE/FIXED LOW DROPOUT LINEAR REGULATOR

■ DESCRIPTION

The UTC **UZ1084-ADJ/Fixed** voltages are low dropout three-terminal regulators with 5A output current capability. These devices have been optimized for low voltage applications including VTT bus termination, where transient response and minimum input voltage are critical.

On-chip thermal limiting provides protection against any combination of overload and ambient temperature that would create excessive junction temperatures.

■ FEATURES

- *Fast transient response
- *Low dropout Voltage at up to 5A
- *Load regulation : 0.5% typical
- *On-chip thermal limiting

■ APPLICATIONS

- *Desktop PCs, RISC and embedded processors' supply
- *GTI, SSTL logic reference bus supply
- *Low voltage V_{CC} logic supply
- *Battery-powered circuitry
- *Post regulator for switching supply
- *Cable and ADSL modems' DSP core supply
- *Set Top Boxes and Web Boxes modules' supply

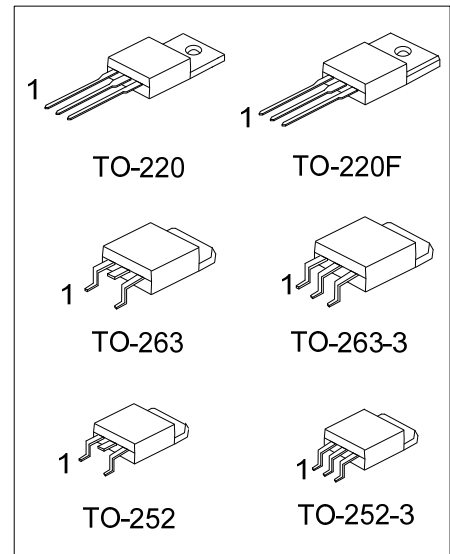

ORDERING INFORMATION

Ordering Number		Package	Pin Assignment			Packing
Lead Free	Halogen Free		1	2	3	
UZ1084L-xx-TA3-T	UZ1084G-xx-TA3-T	TO-220	A/G	O	I	Tube
UZ1084L-xx-TF3-T	UZ1084G-xx-TF3-T	TO-220F	A/G	O	I	Tube
UZ1084L-xx-TN3-R	UZ1084G-xx-TN3-R	TO-252	A/G	O	I	Tape Reel
UZ1084L-xx-TNA-R	UZ1084G-xx-TNA-R	TO-252-3	A/G	O	I	Tape Reel
UZ1084L-xx-TQ2-T	UZ1084G-xx-TQ2-T	TO-263	A/G	O	I	Tube
UZ1084L-xx-TQ2-R	UZ1084G-xx-TQ2-R	TO-263	A/G	O	I	Tape Reel
UZ1084L-xx-TQ3-T	UZ1084G-xx-TQ3-T	TO-263-3	A/G	O	I	Tube
UZ1084L-xx-TQ3-R	UZ1084G-xx-TQ3-R	TO-263-3	A/G	O	I	Tape Reel

Notes: 1. xx: Output voltage, refer to Marking Information.

2. A: ADJ (for adjustable regulator), G: GND (for fixed regulator), O:V_{OUT}, I:V_{IN}

<p>UZ1084G-xx-TA3-T</p> <p>(1) Packing Type (2) Package Type (3) Output Voltage Code (4) Green Package</p>	<p>(1) R: Tape Reel, T: Tube (2) TA3: TO-220, TF3: TO-220F, TN3: TO-252, TNA: TO-252-3, TQ2: TO-263, TQ3: TO-263-3 (3) xx: refer to Marking Information (4) G: Halogen Free and Lead Free, L: Lead Free</p>
--	---

MARKING INFORMATION

PACKAGE	VOLTAGE CODE	MARKING
TO-220	15 :1.5V	<p>Lot Code ← UTC UZ1084 XX □ □ □ □ → Date Code L: Lead Free G: Halogen Free</p>
TO-220F	18 :1.8V	
TO-252	25 :2.5V	
TO-252-3	33 :3.3V	
TO-263	50 :5.0V	
TO-263-3	AD:ADJ	

■ ABSOLUTE MAXIMUM RATINGS (T_A=25°C, unless otherwise specified)

PARAMETER	SYMBOL	RATINGS	UNIT
DC Input Voltage	V _{IN}	15	V
Operating Temperature	T _{OPR}	-40 ~ +125	°C
Storage Temperature	T _{STG}	-65 ~ +150	°C

Note: Absolute maximum ratings are those values beyond which the device could be permanently damaged. Absolute maximum ratings are stress ratings only and functional device operation is not implied.

■ THERMAL DATA

PARAMETER	SYMBOL	RATINGS	UNIT
Junction to Ambient	TO-220	54	°C/W
	TO-252/TO-252-3	112	°C/W
	TO-263/TO-263-3	64	°C/W
Junction to Case	TO-220	4	°C/W
	TO-252/TO-252-3	12	°C/W
	TO-263/TO-263-3	4	°C/W

■ ELECTRICAL CHARACTERISTICS

For UZ1084-Adjustable (Operating Conditions: 4.75 ≤ V_{IN} ≤ 5.25, T_A=25°C unless otherwise specified)

PARAMETER	SYMBOL	TEST CONDITIONS	MIN	TYP	MAX	UNIT
Reference Voltage	V _{REF}	I _{OUT} =10mA	1.23	1.25	1.27	V
Line Regulation	ΔV _{OUT}	I _{OUT} =10mA		0.5	2	%
Load Regulation	ΔV _{OUT}	10mA ≤ I _{OUT} ≤ 5A		0.5	2.5	%
Dropout Voltage	V _D	ΔV _{REF} %=2%, I _O =5A			1.5	V
Current Limit	I _{LIMIT}	(V _{IN} -V _{OUT})=2V	5.5	6.5		A
Adjust Pin Current	I _{ADJ}			35	100	μA
Adjust Pin Current Change	ΔI _{ADJ}	1.5V ≤ (V _{IN} -V _{OUT}) ≤ 5.75V, 10mA ≤ I _{OUT} ≤ 5A			5	μA
Minimum Load Current	I _{O(MIN)}	1.5V ≤ (V _{IN} -V _{OUT}) ≤ 5.75V		5	10	mA
Thermal shutdown				150		°C

For UZ1084-xx (Fixed Voltage)

(Operating Conditions: 1.5V ≤ (V_{IN}-V_{OUT}) ≤ 5.75V, T_A=25°C unless otherwise specified)

PARAMETER	SYMBOL	TEST CONDITIONS	MIN.	TYP	MAX	UNIT	
Output Voltage	V _{OUT}	I _{OUT} =10mA	UZ1084-15	1.470	1.5	1.530	V
		I _{OUT} =10mA	UZ1084-18	1.764	1.8	1.836	V
		I _{OUT} =10mA	UZ1084-25	2.450	2.5	2.550	V
		I _{OUT} =10mA	UZ1084-33	3.234	3.3	3.366	V
		I _{OUT} =10mA	UZ1084-50	4.900	5.0	5.100	V
Line Regulation	ΔV _{OUT}	I _{OUT} =10mA		0.5	2	%	
Load Regulation	ΔV _{OUT}	10mA ≤ I _{OUT} ≤ 5A		0.5	2.5	%	
Dropout Voltage	V _D	ΔV _{REF} %=2%, I _{OUT} =5A			1.5	V	
Current Limit	I _{LIMIT}	(V _{IN} -V _{OUT})=2V	5.5	6.5		A	
Quiescent Current	I _Q	V _{IN} =12V		10	13	mA	
Thermal shutdown				150		°C	

■ TYPICAL APPLICATION CIRCUITS

Adjustable Voltage Regulator

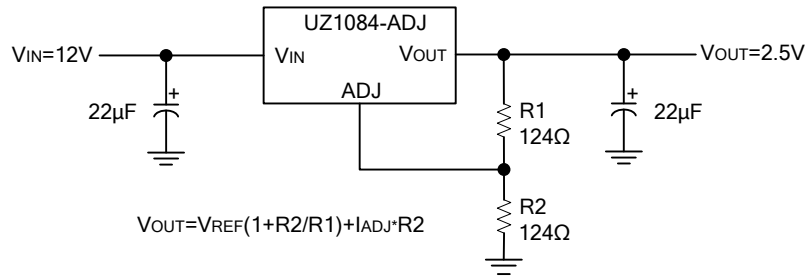

Fixed Voltage Regulator

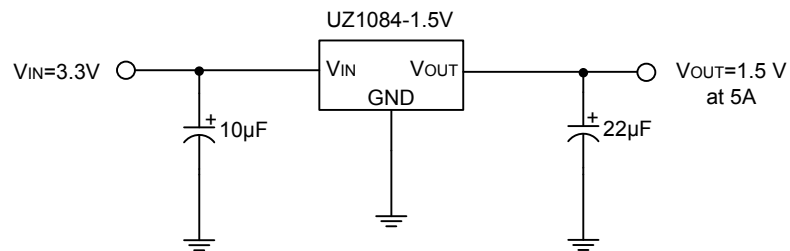

TYPICAL CHARACTERISTICS

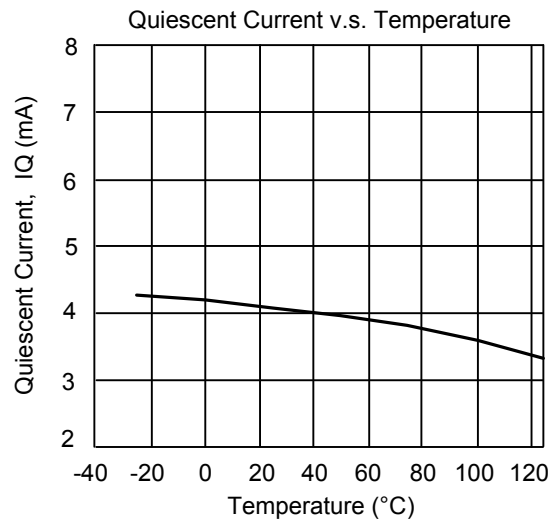
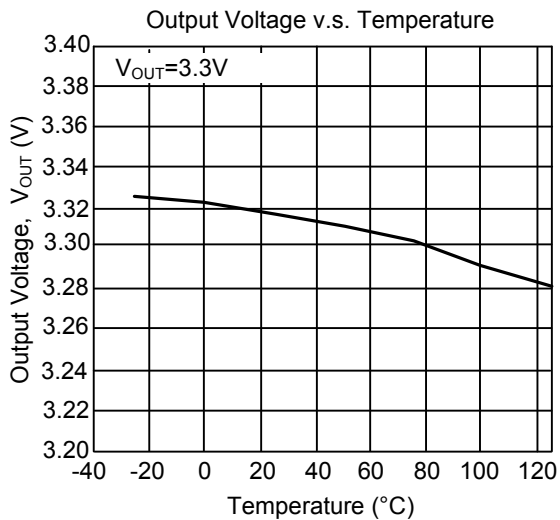
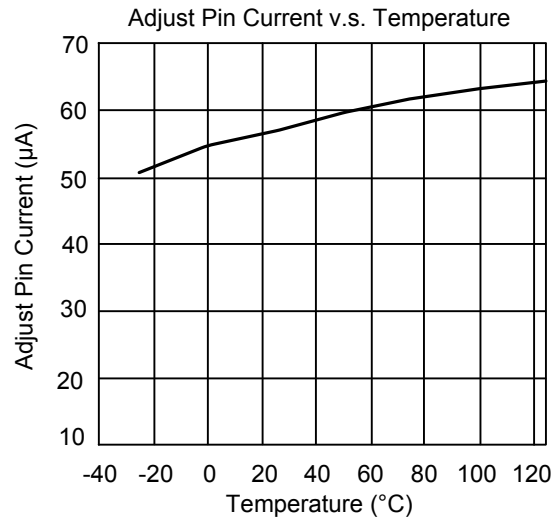
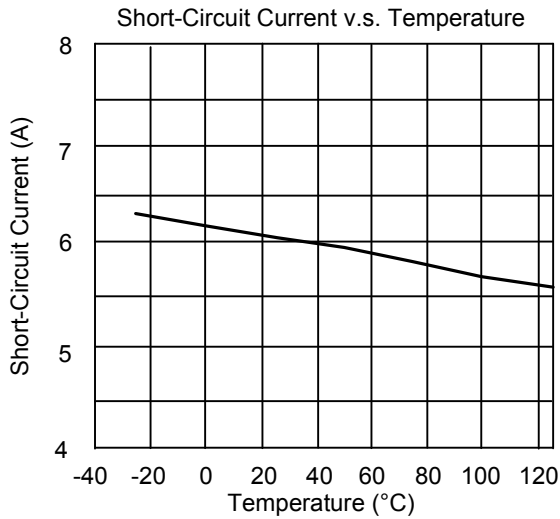
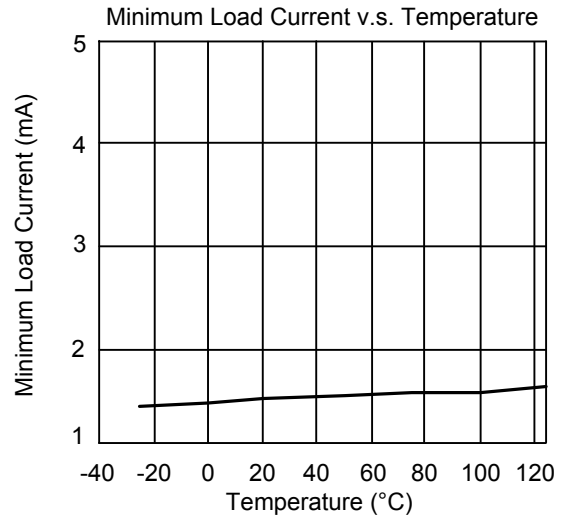
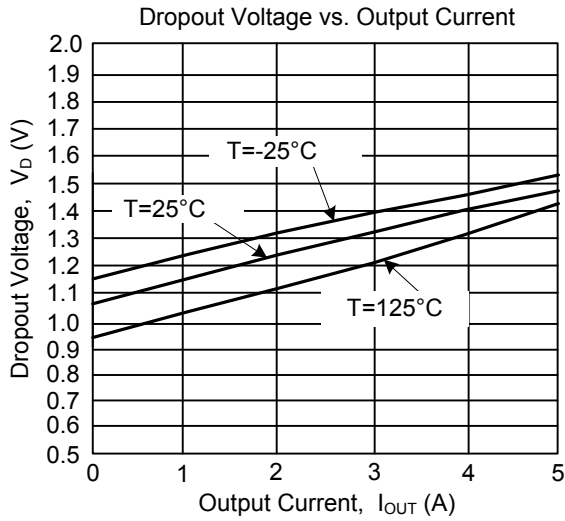

■ TYPICAL CHARACTERISTICS (Cont.)

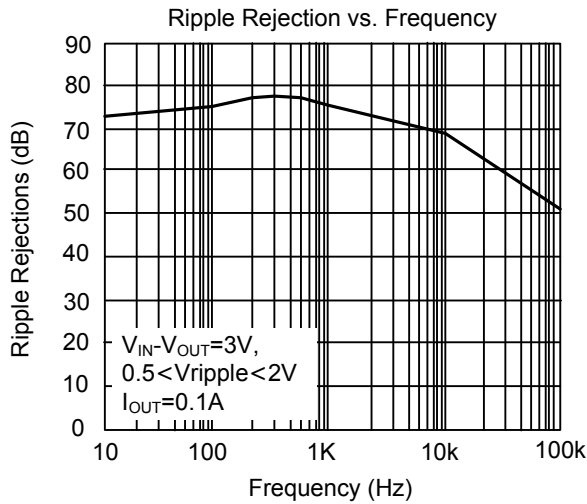
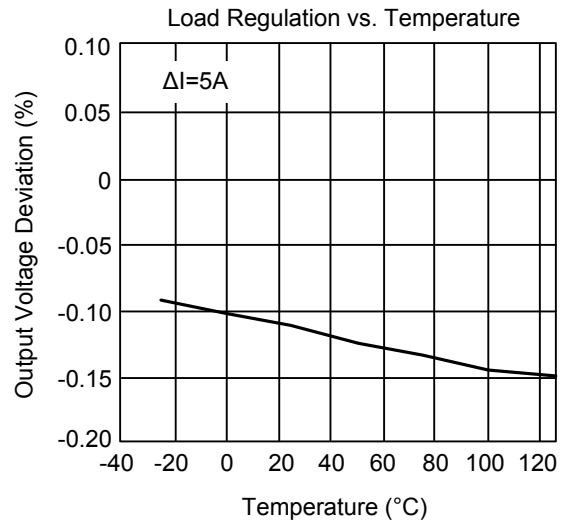
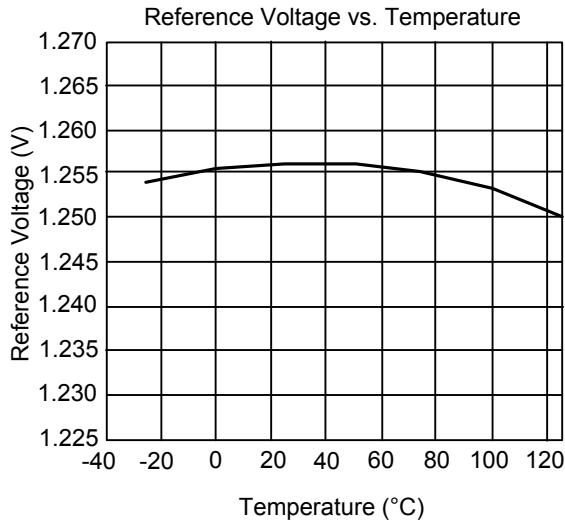

UTC assumes no responsibility for equipment failures that result from using products at values that exceed, even momentarily, rated values (such as maximum ratings, operating condition ranges, or other parameters) listed in products specifications of any and all UTC products described or contained herein. UTC products are not designed for use in life support appliances, devices or systems where malfunction of these products can be reasonably expected to result in personal injury. Reproduction in whole or in part is prohibited without the prior written consent of the copyright owner. UTC reserves the right to make changes to information published in this document, including without limitation specifications and product descriptions, at any time and without notice. This document supersedes and replaces all information supplied prior to the publication hereof.