

Zero-Drift, Rail-to-Rail I/O CMOS Operational Amplifiers

1 FEATURES

- Qualified for Automotive Applications
- AEC-Q100 Qualified with the Grade 1
- Low Offset Voltage: $\pm 10\mu\text{V}$ (TYP)
- Input Offset Drift: $\pm 0.05\mu\text{V}/^\circ\text{C}$
- High Gain Bandwidth Product: 4.3MHz
- Rail-to-Rail Input and Output
- High Gain, CMRR, PSRR: 120dB
- High Slew Rate: 2.5V/ μs
- Low Noise: 0.93uVp-p (0.1Hz~10Hz)
- Low Power Consumption: 650 μA /op amp
- Overload Recovery Time: 1us
- Low Supply Voltage: +2.7V to +5.5V
- No External Capacitors Required
- Extended Temperature: -40°C to +125°C

2 APPLICATIONS

- Automotive Applications:
 - ADAS
 - Body Electronics and Lighting
 - Current Sensing
 - Battery Management Systems
- Temperature Sensors
- Medical/Industrial Instrumentation
- Pressure Sensors
- Battery-Powered Instrumentation

3 DESCRIPTIONS

The RS8557-Q1, RS8558-Q1, RS8559-Q1 series of CMOS operational amplifiers use auto-zero techniques to simultaneously provide very low offset voltage (100 μV max) and near-zero drift over time and temperature. This family of amplifiers has ultralow noise, offset and power.

This miniature, high-precision operational amplifiers offset high input impedance and rail-to-rail input and rail-to-rail output swing. With high gain-bandwidth product of 4.3MHz and slew rate of 2.5V/ μs .

Single or dual supplies as low as +2.7V ($\pm 1.35\text{V}$) and up to +5.5V ($\pm 2.75\text{V}$) may be used.

The RS8557-Q1/RS8558-Q1/RS8559-Q1 are specified for the extended industrial and automotive temperature range (-40°C to 125°C). The RS8557-Q1 single amplifier is available in 5-lead SOT23, The RS8558-Q1 dual amplifier is available in 8-lead SOIC and 8-lead MSOP narrow surface mount packages, the RS8559-Q1 quad amplifier is available in 14-lead SOIC and 14-lead narrow TSSOP packages.

Device Information (1)

PART NUMBER	PACKAGE	BODY SIZE (NOM)
RS8557-Q1	SOT23-5	2.92mmx1.62mm
RS8558-Q1	SOIC-8(SOP8)	4.90mmx3.90mm
	MSOP-8	3.00mmx3.00mm
RS8559-Q1	SOIC-14 (SOP14)	8.65mmx3.90mm
	TSSOP-14	5.00mmx4.40mm

(1) For all available packages, see the orderable addendum at the end of the data sheet.

Table of Contents

1 FEATURES	1
2 APPLICATIONS	1
3 DESCRIPTIONS	1
4 Revision History	3
5 PACKAGE/ORDERING INFORMATION ⁽¹⁾	4
6 Pin Configuration and Functions (Top View)	5
7 SPECIFICATIONS	7
7.1 Absolute Maximum Ratings	7
7.2 ESD Ratings	7
7.3 Recommended Operating Conditions	7
7.4 ELECTRICAL CHARACTERISTICS	8
7.5 TYPICAL CHARACTERISTICS	10
8 Detailed Description	12
8.1 Overview	12
8.2 OPERATING VOLTAGE	12
9 Application and Implementation	13
9.1 APPLICATION NOTE	13
9.2 Bidirectional Current-Sensing	13
9.3 Design Requirements	13
9.4 Detailed Design Procedure	13
9.5 Application Curve	14
10 LAYOUTS	15
10.1 Layout Guidelines	15
10.2 Layout Example	15
11 PACKAGE OUTLINE DIMENSIONS	16
12 TAPE AND REEL INFORMATION	22

4 Revision History

Note: Page numbers for previous revisions may differ from page numbers in the current version.

Version	Change Date	Change Item
A.1	2023/03/01	Initial version completed

5 PACKAGE/ORDERING INFORMATION (1)

Orderable Device	Package Type	Pin	Channel	Lead finish/Ball material (2)	MSL Peak Temp (3)	Op Temp (°C)	Device Marking (4)	Package Qty
RS8557XF-Q1	SOT23-5	5	1	NIPDAUAG	MSL1-260° -Unlimited	-40°C ~ 125°C	8557	Tape and Reel,3000
RS8558XK-Q1	SOIC-8 (SOP8)	8	2	NIPDAUAG	MSL1-260° -Unlimited	-40°C ~125°C	RS8558	Tape and Reel,4000
RS8558XM-Q1	MSOP-8	8	2	NIPDAUAG	MSL1-260° -Unlimited	-40°C ~125°C	RS8558	Tape and Reel,4000
RS8559XP-Q1	SOIC-14 (SOP14)	14	4	NIPDAUAG	MSL1-260° -Unlimited	-40°C ~125°C	RS8559	Tape and Reel,4000
RS8559XQ-Q1	TSSOP-14	14	4	NIPDAUAG	MSL1-260° -Unlimited	-40°C ~125°C	RS8559	Tape and Reel,4000

NOTE:

- (1) This information is the most current data available for the designated devices. This data is subject to change without notice and revision of this document. For browser-based versions of this data sheet, refer to the right-hand navigation.
- (2) Lead finish/Ball material. Orderable Devices may have multiple material finish options. Finish options are separated by a vertical ruled line. Lead finish/Ball material values may wrap to two lines if the finish value exceeds the maximum column width.
- (3) MSL Peak Temp. The Moisture Sensitivity Level rating according to the JEDEC industry standard classifications, and peak solder temperature.
- (4) There may be additional marking, which relates to the lot trace code information (data code and vendor code), the logo or the environmental category on the device.

6 Pin Configuration and Functions (Top View)

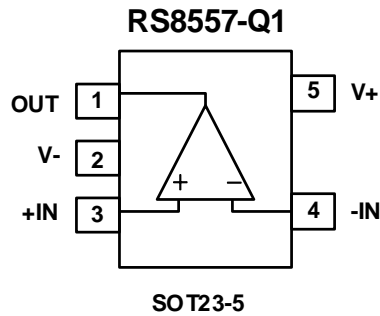

Pin Description

NAME	PIN		I/O ⁽¹⁾	DESCRIPTION
	RS8557-Q1			
	SOT23-5			
-IN	4	I	Negative (inverting) input	
+IN	3	I	Positive (noninverting) input	
OUT	1	O	Output	
V-	2	-	Negative (lowest) power supply	
V+	5	-	Positive (highest) power supply	

(1) I = Input, O = Output.

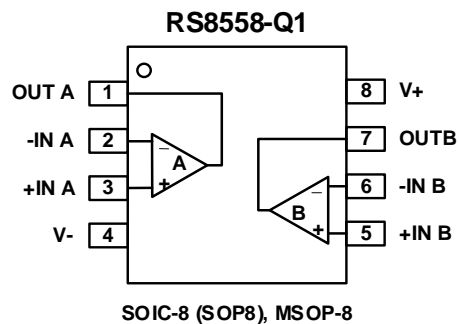

Pin Description

NAME	PIN		I/O ⁽¹⁾	DESCRIPTION
	SOIC-8 (SOP8)/ MSOP8			
-INA	2	I	Inverting input, channel A	
+INA	3	I	Noninverting input, channel A	
-INB	6	I	Inverting input, channel B	
+INB	5	I	Noninverting input, channel B	
OUTA	1	O	Output, channel A	
OUTB	7	O	Output, channel B	
V-	4	-	Negative (lowest) power supply	
V+	8	-	Positive (highest) power supply	

(1) I = Input, O = Output.

Pin Configuration and Functions (Top View)

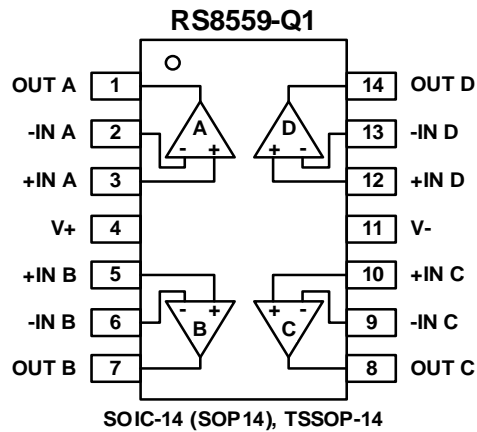

Pin Description

NAME	PIN	I/O ⁽¹⁾	DESCRIPTION
	SOIC-14 (SOP14)/ TSSOP-14		
-INA	2	I	Inverting input, channel A
+INA	3	I	Noninverting input, channel A
-INB	6	I	Inverting input, channel B
+INB	5	I	Noninverting input, channel B
-INC	9	I	Inverting input, channel C
+INC	10	I	Noninverting input, channel C
-IND	13	I	Inverting input, channel D
+IND	12	I	Noninverting input, channel D
OUTA	1	O	Output, channel A
OUTB	7	O	Output, channel B
OUTC	8	O	Output, channel C
OUTD	14	O	Output, channel D
V-	11	-	Negative (lowest) power supply
V+	4	-	Positive (highest) power supply

(1) I = Input, O = Output.

7 SPECIFICATIONS

7.1 Absolute Maximum Ratings

Over operating free-air temperature range (unless otherwise noted) ⁽¹⁾

		MIN	MAX	UNIT	
Voltage	Supply, $V_S=(V+) - (V-)$		7	V	
	Signal input pin ⁽²⁾	(V-)-0.5	(V+) +0.5		
	Signal output pin ⁽³⁾	(V-)-0.5	(V+) +0.5		
Current	Signal input pin ⁽²⁾	-10	10	mA	
	Signal output pin ⁽³⁾	-55	55	mA	
	Output short-circuits ⁽⁴⁾	Continuous			
θ_{JA}	Package thermal impedance ⁽⁵⁾	SOT23-5		230	°C/W
		SOIC-8(SOP8)		110.88	
		MSOP-8		165.7	
		SOIC-14(SOP14)		104.5	
		TSSOP14		89.21	
Temperature	Operating range, T_A	-40	125	°C	
	Junction, T_J ⁽⁶⁾	-40	150		
	Storage, T_{stg}	-65	150		

(1) Stresses above these ratings may cause permanent damage. Exposure to absolute maximum conditions for extended periods may degrade device reliability. These are stress ratings only, and functional operation of the device at these or any other conditions beyond those specified is not implied.

(2) Input terminals are diode-clamped to the power-supply rails. Input signals that can swing more than 0.5V beyond the supply rails should be current-limited to 10mA or less.

(3) Output terminals are diode-clamped to the power-supply rails. Output signals that can swing more than 0.5V beyond the supply rails should be current-limited to ± 55 mA or less.

(4) Short-circuit to ground, one amplifier per package.

(5) The package thermal impedance is calculated in accordance with JESD-51.

(6) The maximum power dissipation is a function of $T_{J(MAX)}$, $R_{\theta JA}$, and T_A . The maximum allowable power dissipation at any ambient temperature is $P_D = (T_{J(MAX)} - T_A) / R_{\theta JA}$. All numbers apply for packages soldered directly onto a PCB.

7.2 ESD Ratings

The following ESD information is provided for handling of ESD-sensitive devices in an ESD protected area only.

		VALUE	UNIT
$V_{(ESD)}$	Electrostatic discharge	Human-Body Model (HBM), per AEC Q100-002 ⁽¹⁾	± 2000
		Charged-Device Model (CDM), per AEC Q100-011	± 500
		Latch-Up (LU), per AEC Q100-004	± 100

(1) AEC Q100-002 indicates that HBM stressing shall be in accordance with the ANSI/ESDA/JEDEC JS-001 specification.



ESD SENSITIVITY CAUTION

ESD damage can range from subtle performance degradation to complete device failure. Precision integrated circuits may be more susceptible to damage because very small parametric changes could cause the device not to meet its published specifications.

7.3 Recommended Operating Conditions

Over operating free-air temperature range (unless otherwise noted)

		MIN	NOM	MAX	UNIT
Supply voltage, $V_S= (V+) - (V-)$	Single-supply	2.7		5.5	V
	Dual-supply	± 1.35		± 2.75	

7.4 ELECTRICAL CHARACTERISTICS

Boldface limits apply over the specified temperature range, Full ⁽⁹⁾ = -40°C to +125°C.

(At T_A = +25°C, V_S = 5V, R_L = 10kΩ connected to V_S/2, and V_{OUT} = V_S/2, unless otherwise noted.) ⁽¹⁾

PARAMETER	SYMBOL	CONDITION	T _J	RS8557-8-9-Q1			UNIT
				MIN ⁽²⁾	TYP ⁽³⁾	MAX ⁽²⁾	
OFFSET VOLTAGE							
Input Offset Voltage	V _{OS}	V _{CM} = V _S /2	25°C	-50	±10	50	μV
			Full	-100		100	
Input Offset Voltage Average Drift	V _{OS} T _C		Full		±0.05		μV/°C
Power-Supply Rejection Ratio	PSRR	V _S = +2.7V to +5.5V V _{CM} < V _S - 2V	25°C	105	120		dB
			Full	90			
Channel Separation, dc			25°C		0.13		μV/V
INPUT BIAS CURRENT							
Input Bias Current ⁽⁴⁾ ⁽⁵⁾	I _B	V _{CM} = V _S /2	25°C		±50		pA
Input Offset Current ⁽⁵⁾	I _{OS}	V _{CM} = V _S /2	25°C		±10		pA
NOISE PERFORMANCE							
Input Voltage Noise	e _n p-p	f = 0.1Hz to 10Hz	25°C		0.93		μV _{pp}
Input Voltage Noise Density ⁽⁵⁾	e _n	f = 1KHz	25°C		45		nV/√Hz
INPUT VOLTAGE RANGE							
Common-Mode Voltage Range	V _{CM}		Full	(V ₋)-0.1		(V ₊)+0.1	V
Common-Mode Rejection Ratio	CMRR	(V ₋)-0.1V < V _{CM} < (V ₊)+0.1V	25°C	105	120		dB
			Full	100			
INPUT CAPACITANCE							
Differential			25°C		1		pF
Common-Mode			25°C		25		pF
DYNAMIC PERFORMANCE							
Slew Rate ⁽⁸⁾	SR	G = +1	25°C		2.5		V/μs
Gain-Bandwidth Product	GBW		25°C		4.3		MHz
Overload Recovery Time	t _{OR}		25°C		1		us
OUTPUT CHARACTERISTICS							
Open-Loop Voltage Gain	A _{OL}	R _L = 10KΩ V _O = 0.3V to 4.7V	25°C	105	120		dB
			Full	105			
Voltage output swing from rail	V _{OH}	R _L = 10 KΩ to GND	25°C		8	20	mV
			Full			30	
	V _{OL}	R _L = 10 KΩ to V ₊	25°C		8	20	mV
			Full			30	
Short-Circuit Current ⁽⁶⁾ ⁽⁷⁾	I _{SC}		25°C	±30	±48		mA
			Full	±25			
POWER SUPPLY							
Operating Voltage Range	V _S		25°C	2.7		5.5	V
Quiescent Current/ Amplifier	I _Q	V _S = 5V	25°C		0.65	1.05	mA
			Full			1.1	

NOTE:

- (1) Electrical table values apply only for factory testing conditions at the temperature indicated. Factory testing conditions result in very limited self-heating of the device.
- (2) Limits are 100% production tested at 25°C. Limits over the operating temperature range are ensured through correlations using statistical quality control (SQC) method.
- (3) Typical values represent the most likely parametric norm as determined at the time of characterization. Actual typical values may vary over time and will also depend on the application and configuration.
- (4) Positive current corresponds to current flowing into the device.
- (5) This parameter is ensured by design and/or characterization and is not tested in production.
- (6) The maximum power dissipation is a function of $T_{J(MAX)}$, $R_{\theta JA}$, and T_A . The maximum allowable power dissipation at any ambient temperature is $PD = (T_{J(MAX)} - T_A) / R_{\theta JA}$. All numbers apply for packages soldered directly onto a PCB.
- (7) Short circuit test is a momentary test.
- (8) Number specified is the slower of positive and negative slew rates.
- (9) Specified by characterization only.

7.5 TYPICAL CHARACTERISTICS

NOTE: The graphs and tables provided following this note are a statistical summary based on a limited number of samples and are provided for informational purposes only.

At $T_A = +25^\circ\text{C}$, $V_S = 5\text{V}$, $R_L = 10\text{k}\Omega$ connected to $V_S/2$, $V_{OUT} = V_S/2$, unless otherwise noted.

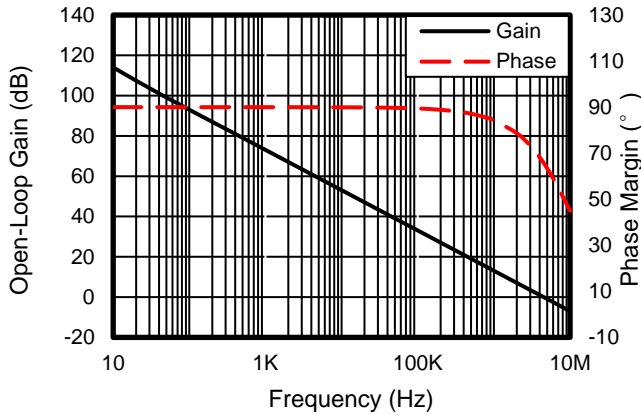

Figure 1. Open-Loop Gain and Phase vs Frequency

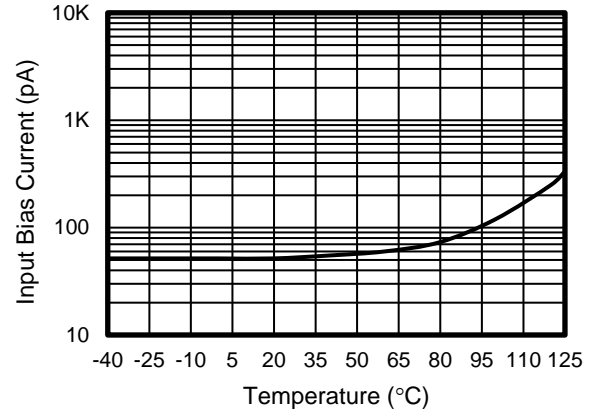

Figure 2. Input Bias Current vs Temperature

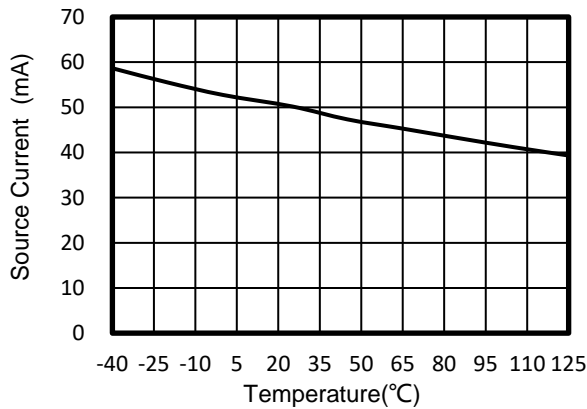

Figure 3. Source Current vs Temperature

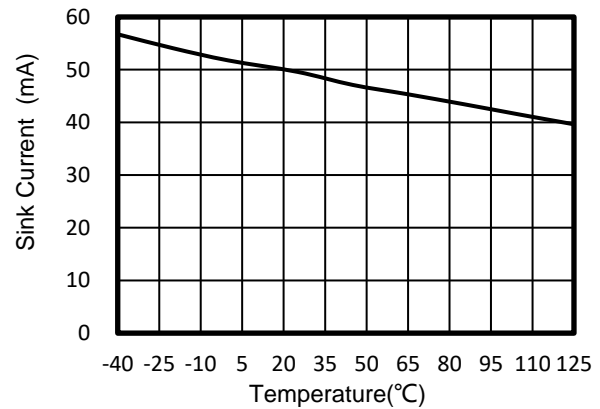

Figure 4. Sink Current vs Temperature

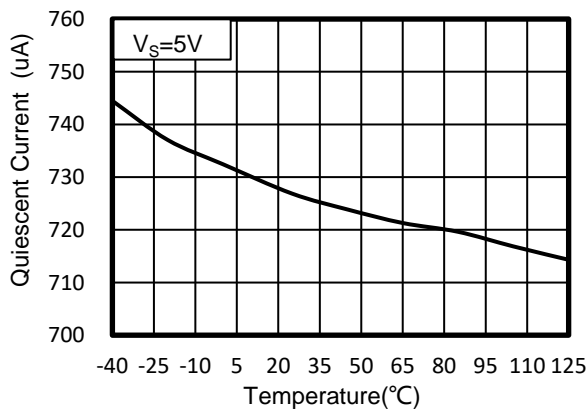

Figure 5. Quiescent Current vs Temperature

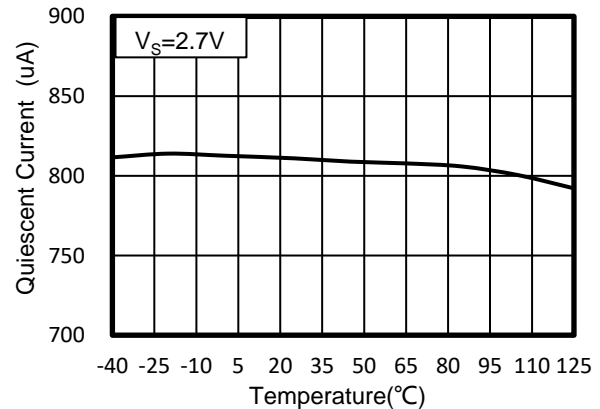

Figure 6. Quiescent Current vs Temperature

TYPICAL CHARACTERISTICS

NOTE: The graphs and tables provided following this note are a statistical summary based on a limited number of samples and are provided for informational purposes only.

At $T_A = +25^\circ\text{C}$, $V_S = 5\text{V}$, $R_L = 10\text{k}\Omega$ connected to $V_S/2$, $V_{OUT} = V_S/2$, unless otherwise noted.

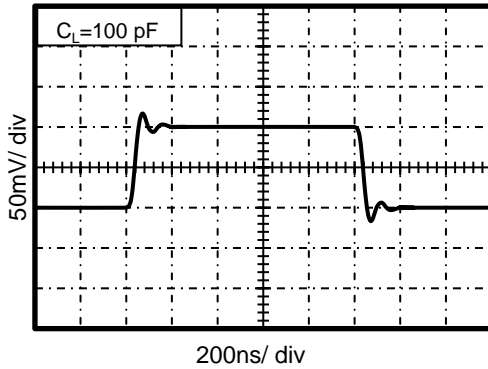

Figure 7. Small-Signal Step Response

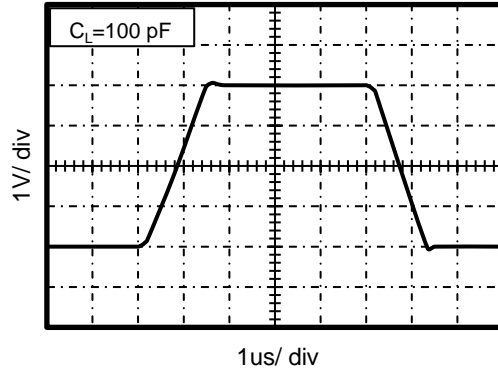

Figure 8. Large-Signal Step Response

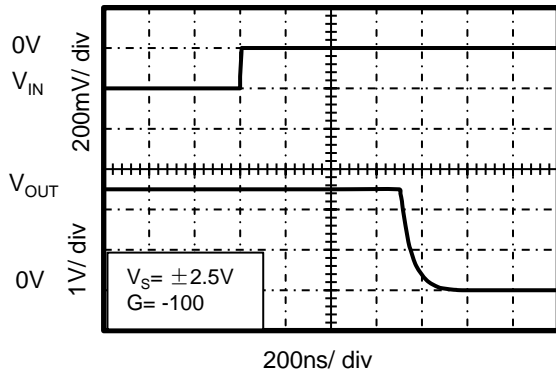

Figure 9. Positive Overvoltage Recovery

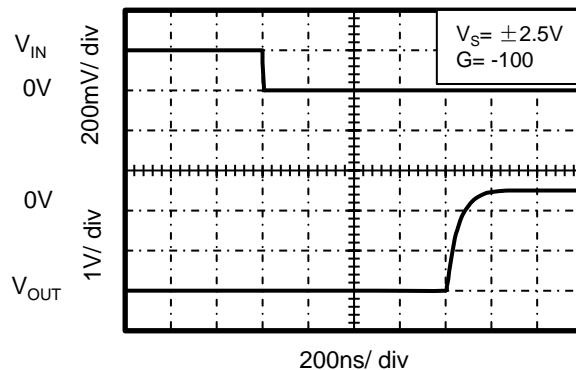

Figure 10. Negative Overvoltage Recovery

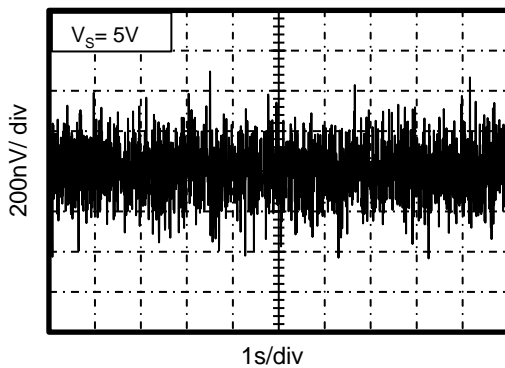

Figure 11. 0.1Hz to 10Hz Noise

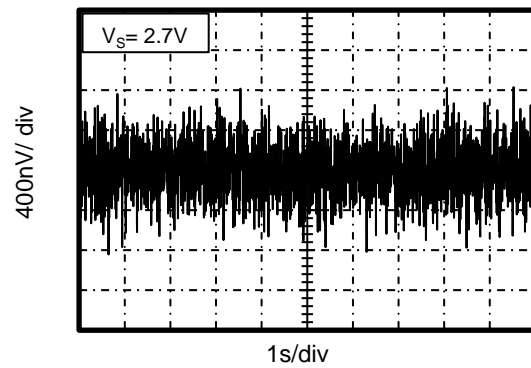

Figure 12. 0.1Hz to 10Hz Noise

8 Detailed Description

8.1 Overview

The RS8557-Q1, RS8558-Q1, RS8559-Q1 series op amps are unity-gain stable and free from unexpected output phase reversal. They use auto-zeroing techniques to provide low offset voltage and very low drift over time and temperature.

Good layout practice mandates use of a 0.1 μ F capacitor placed closely across the supply pins.

For lowest offset voltage and precision performance, circuit layout and mechanical conditions should be optimized. Avoid temperature gradients that create thermoelectric (Seebeck) effects in thermocouple junctions formed from connecting dissimilar conductors. These thermally-generated potentials can be made to cancel by assuring that they are equal on both input terminals.

- Use low thermoelectric-coefficient connections (avoid dissimilar metals).
- Thermally isolate components from power supplies or other heat-sources.
- Shield op amp and input circuitry from air currents, such as cooling fans.

Following these guidelines will reduce the likelihood of junctions being at different temperatures, which can cause thermoelectric voltages of 0.1 μ V/ $^{\circ}$ C or higher, depending on materials used.

8.2 OPERATING VOLTAGE

The RS8557-Q1, RS8558-Q1, RS8559-Q1 series op amps operate over a power-supply range of +2.7V to +5.5V (\pm 1.35V to \pm 2.75V). Supply voltages higher than 7V (absolute maximum) can permanently damage the amplifier. Parameters that vary over supply voltage or temperature are shown in the Typical Characteristics section of this data sheet.

9 Application and Implementation

Information in the following applications sections is not part of the Runic component specification, and Runic does not warrant its accuracy or completeness. Runic's customers are responsible for determining suitability of components for their purposes. Customers should validate and test their design implementation to confirm system functionality.

9.1 APPLICATION NOTE

Typical Applications

9.2 Bidirectional Current-Sensing

This single-supply, low-side, bidirectional current-sensing solution detects load currents from -1A to 1A. The single-ended output spans from 110mV to 3.19V. This design uses the RS8557-Q1, RS8558-Q1, RS8559-Q1 because of its low offset voltage and rail-to-rail input and output. One of the amplifiers is configured as a difference amplifier and the other provides the reference voltage.

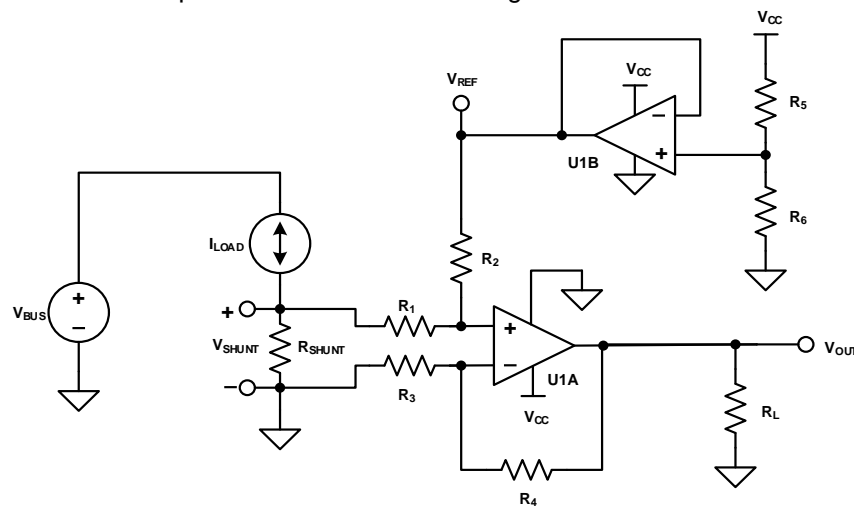

Figure 13. Bidirectional Current-Sensing Schematic

9.3 Design Requirements

This solution has the following requirements:

- Supply voltage: 3.3V
- Input: -1 A to 1 A
- Output: 1.65V ±1.54V (110mV to 3.19V)

9.4 Detailed Design Procedure

The load current, I_{LOAD} , flows through the shunt resistor (R_{SHUNT}) to develop the shunt voltage, V_{SHUNT} . The shunt voltage is then amplified by the difference amplifier, which consists of U1A and R_1 through R_4 . The gain of the difference amplifier is set by the ratio of R_4 to R_3 . To minimize errors, set $R_2 = R_4$ and $R_1 = R_3$. The reference voltage, V_{REF} , is supplied by buffering a resistor divider using U1B. The transfer function is given by Equation 1.

$$V_{OUT} = V_{SHUNT} \times \text{Gain}_{\text{Diff_Amp}} + V_{REF}$$

Where

$$V_{SHUNT} = I_{LOAD} \times R_{SHUNT}$$

$$\text{Gain}_{\text{Diff_Amp}} = \frac{R_4}{R_3}$$

$$V_{REF} = V_{CC} \times \left(\frac{R_6}{R_5 + R_6} \right)$$

(1)

There are two types of errors in this design: offset and gain. Gain errors are introduced by the tolerance of the shunt resistor and the ratios of R_4 to R_3 and, similarly, R_2 to R_1 . Offset errors are introduced by the voltage divider (R_5 and R_6) and how closely the ratio of R_4/R_3 matches R_2/R_1 . The latter value impacts the CMRR of the

difference amplifier, which ultimately translates to an offset error. Because this is a low-side measurement, the value of V_{SHUNT} is the ground potential for the system load. Therefore, it is important to place a maximum value on V_{SHUNT} . In this design, the maximum value for V_{SHUNT} is set to 100 mV. Equation 2 calculates the maximum value of the shunt resistor given a maximum shunt voltage of 100 mV and maximum load current of 1 A.

$$R_{SHUNT(Max)} = \frac{V_{SHUNT(Max)}}{I_{LOAD(Max)}} = \frac{100 \text{ mV}}{1 \text{ A}} = 100 \text{ m}\Omega \quad (2)$$

The tolerance of R_{SHUNT} is directly proportional to cost. For this design, a shunt resistor with a tolerance of 0.5% was selected. If greater accuracy is required, select a 0.1% resistor or better.

The load current is bidirectional; therefore, the shunt voltage range is -100 mV to 100 mV. This voltage is divided down by R_1 and R_2 before reaching the operational amplifier, U1A. Take care to ensure that the voltage present at the noninverting node of U1A is within the common-mode range of the device. Therefore, it is important to use an operational amplifier, such as the RS8557-Q1, RS8558-Q1, and RS8559-Q1 that has a common-mode range that extends below the negative supply voltage. Finally, to minimize offset error, note that the RS8557-Q1, RS8558-Q1, RS8559-Q1 has a typical offset voltage of $\pm 3\mu\text{V}$ ($\pm 20\mu\text{V}$ maximum). Given a symmetric load current of -1A to 1A, the voltage divider resistors (R_5 and R_6) must be equal. To be consistent with the shunt resistor, a tolerance of 0.5% was selected. To minimize power consumption, 10k Ω resistors were used. To set the gain of the difference amplifier, the common-mode range and output swing of the RS8557-Q1, RS8558-Q1, and RS8559-Q1 must be considered. Equation 3 and Equation 4 depict the typical common-mode range and maximum output swing, respectively of the RS8557-Q1, RS8558-Q1, and RS8559-Q1 given a 3.3V supply.

$$-100\text{mV} < V_{CM} < 3.4\text{V} \quad (3)$$

$$100\text{mV} < V_{OUT} < 3.2\text{V} \quad (4)$$

The gain of the difference amplifier can now be calculated as shown in Equation 5.

$$\text{Gain}_{\text{Diff_Amp}} = \frac{V_{OUT_Max} - V_{OUT_Min}}{R_{SHUNT} \times (I_{MAX} - I_{MIN})} = \frac{3.2 \text{ V} - 100 \text{ mV}}{100 \text{ m}\Omega \times [1 \text{ A} - (-1 \text{ A})]} = 15.5 \frac{\text{V}}{\text{V}} \quad (5)$$

The resistor value selected for R_1 and R_3 was 1k Ω . 15.4k Ω was selected for R_2 and R_4 because it is the nearest standard value. Therefore, the ideal gain of the difference amplifier is 15.4 V/V.

The gain error of the circuit primarily depends on R_1 through R_4 . As a result of this dependence, 0.1% resistors were selected. This configuration reduces the likelihood that the design requires a two-point calibration. A simple one-point calibration, if desired, removes the offset errors introduced by the 0.5% resistors.

9.5 Application Curve

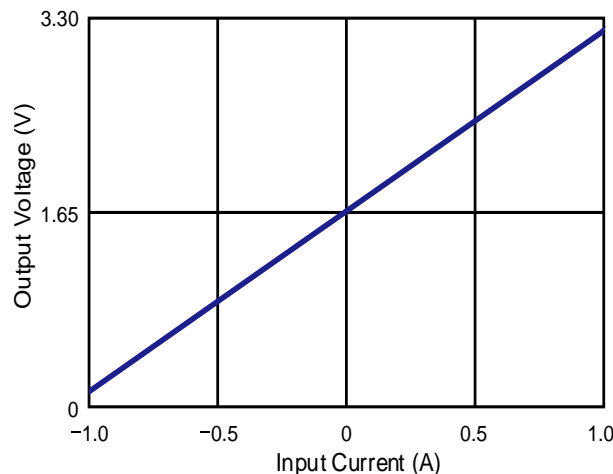

Figure 14. Bidirectional Current-Sensing Circuit Performance: Output Voltage vs Input Current

10 LAYOUTS

10.1 Layout Guidelines

Attention to good layout practices is always recommended. Keep traces short. When possible, use a PCB ground plane with surface-mount components placed as close to the device pins as possible. Place a 0.1uF capacitor closely across the supply pins.

These guidelines should be applied throughout the analog circuit to improve performance and provide benefits such as reducing the EMI susceptibility.

10.2 Layout Example

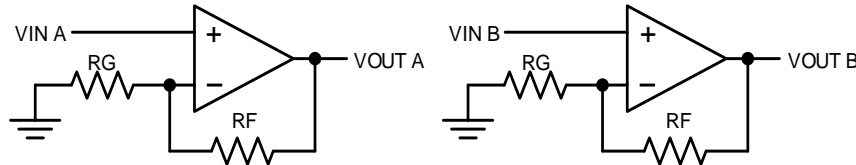

Figure 15. Schematic Representation

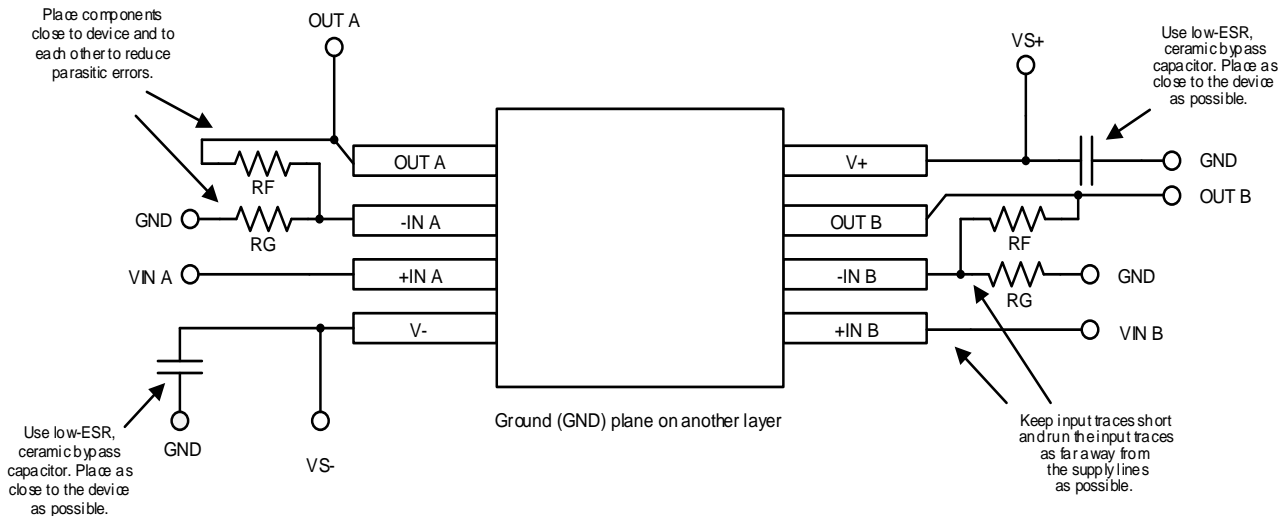
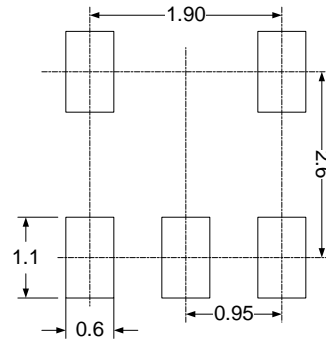
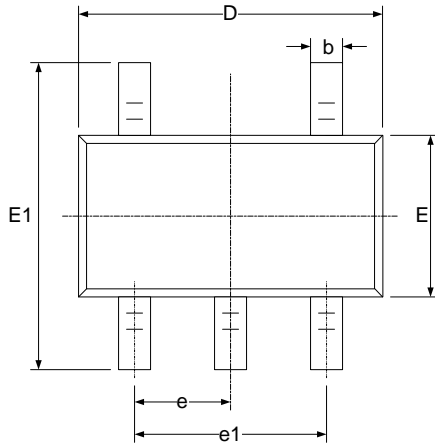
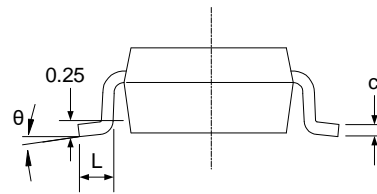
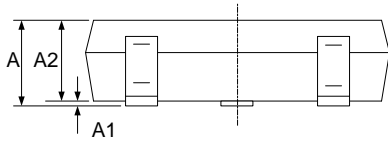
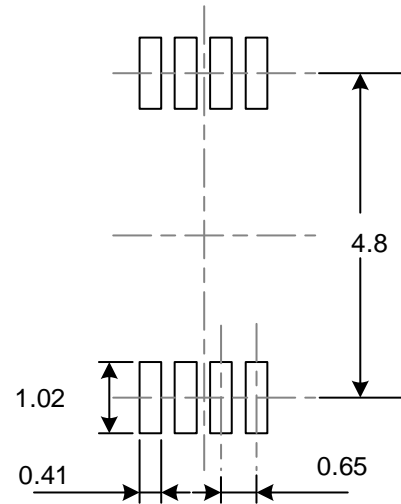
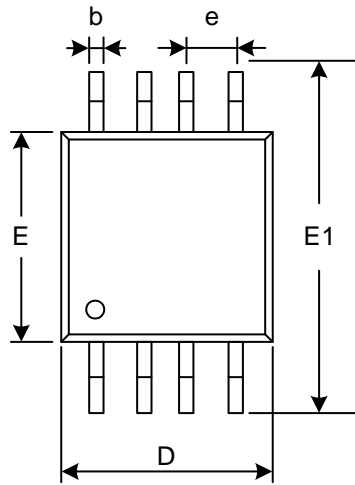
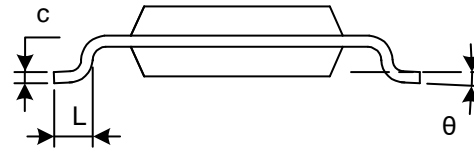
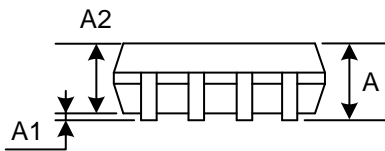

Figure 16. Layout Example

NOTE: Layout Recommendations have been shown for dual op-amp only, follow similar precautions for Single and four.

**11 PACKAGE OUTLINE DIMENSIONS
SOT23-5**

RECOMMENDED LAND PATTERN (Unit: mm)

Symbol	Dimensions In Millimeters		Dimensions In Inches	
	Min	Max	Min	Max
A		1.250		0.049
A1	0.000	0.150	0.000	0.006
A2	1.000	1.200	0.039	0.047
b	0.360	0.500	0.014	0.020
c	0.100	0.200	0.004	0.008
D	2.826	3.026	0.111	0.119
E	1.526	1.726	0.060	0.068
E1	2.600	3.000	0.102	0.118
e	0.950(BSC)		0.037(BSC)	
e1	1.800	2.000	0.071	0.079
L	0.350	0.600	0.014	0.024
θ	0°	8°	0°	8°

MSOP-8

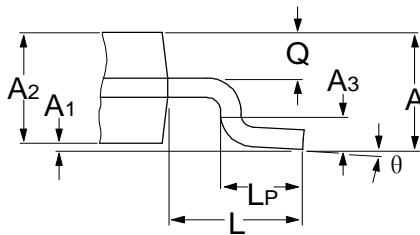
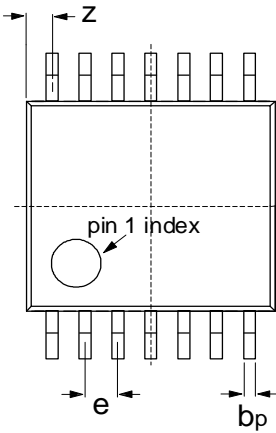
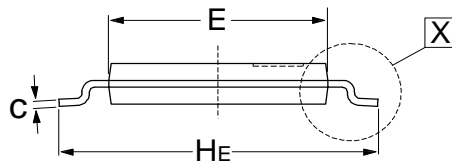
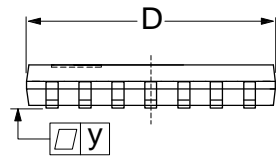
RECOMMENDED LAND PATTERN (Unit: mm)

Symbol	Dimensions In Millimeters		Dimensions In Inches	
	Min	Max	Min	Max
A	0.820	1.100	0.032	0.043
A1	0.020	0.150	0.001	0.006
A2	0.750	0.950	0.030	0.037
b	0.250	0.380	0.010	0.015
c	0.090	0.230	0.004	0.009
D	2.900	3.100	0.114	0.122
e	0.650(BSC)		0.026(BSC)	
E	2.900	3.100	0.114	0.122
E1	4.750	5.050	0.187	0.199
L	0.400	0.800	0.016	0.031
θ	0°	6°	0°	6°

TSSOP-14

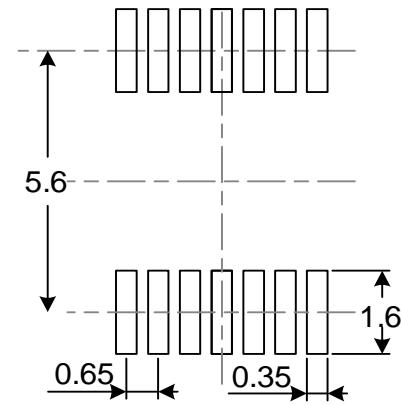
Detail X

RECOMMENDED LAND PATTERN (Unit: mm)

Symbol	Dimensions In Millimeters		Dimensions In Inches	
	Min	Max	Min	Max
A		1.100		0.043
A ₁	0.050	0.150	0.002	0.006
A ₂	0.800	0.950	0.031	0.037
A ₃	0.25		0.010	
b _p	0.190	0.300	0.007	0.012
c	0.100	0.200	0.004	0.008
D ^(A)	4.900	5.100	0.193	0.201
E ^(B)	4.300	4.500	0.169	0.177
H _E	6.200	6.600	0.244	0.260
e	0.650		0.026	
L	1		0.039	
L _P	0.500	0.750	0.020	0.030
Q	0.300	0.400	0.012	0.016
Z ^(A)	0.380	0.720	0.015	0.028
y	0.1		0.004	
θ	0°	8°	0°	8°

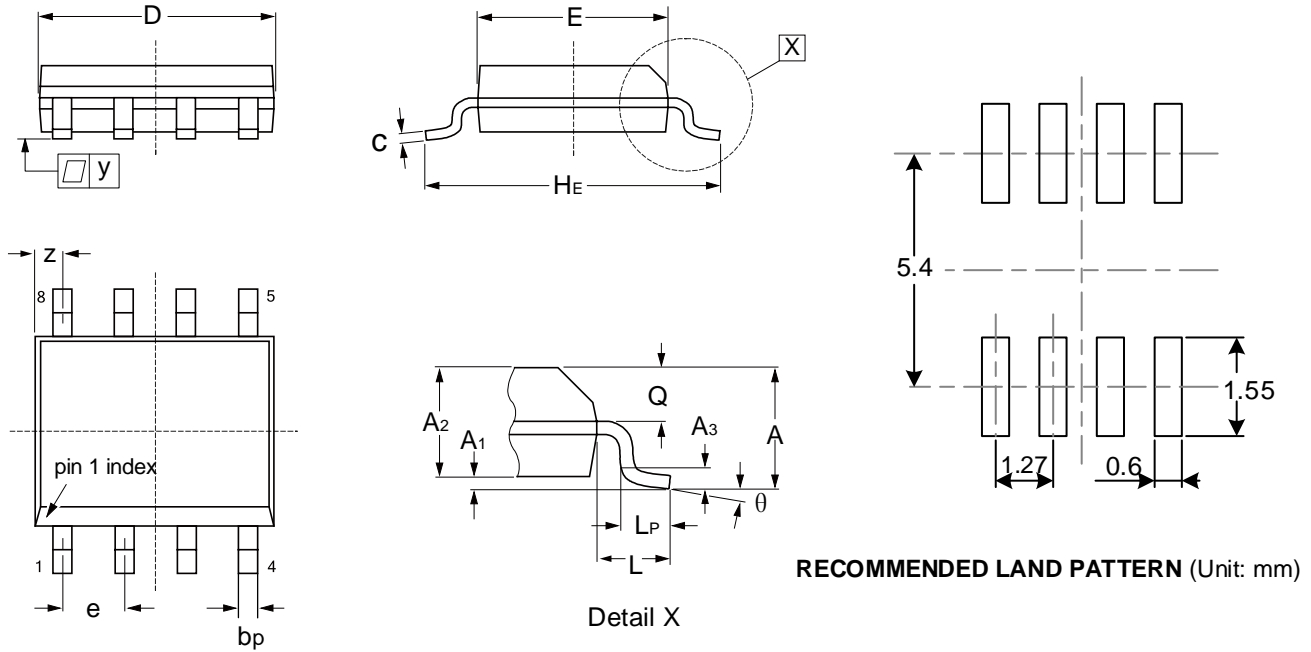
SOIC-8(SOP8)

Symbol	Dimensions In Millimeters		Dimensions In Inches	
	Min	Max	Min	Max
A		1.750		0.069
A ₁	0.100	0.250	0.004	0.010
A ₂	1.250	1.450	0.049	0.057
A ₃	0.25		0.010	
b _p	0.360	0.490	0.014	0.019
c	0.190	0.250	0.007	0.010
D ^(A)	4.800	5.000	0.190	0.200
E ^(B)	3.800	4.000	0.150	0.160
H _E	5.800	6.200	0.228	0.244
e	1.270		0.050	
L	1.05		0.041	
L _P	0.400	1.000	0.016	0.039
Q	0.600	0.700	0.024	0.028
Z ^(A)	0.300	0.700	0.012	0.028
y	0.1		0.004	
θ	0°	8°	0°	8°

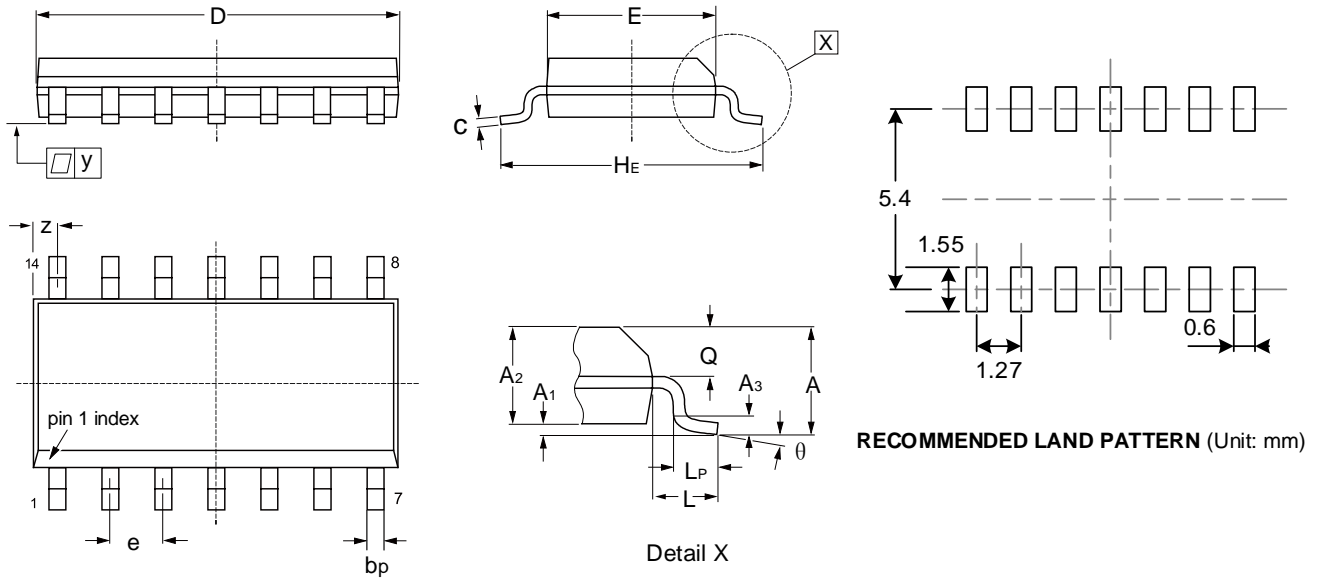
SOIC-14(SOP14)

Symbol	Dimensions In Millimeters		Dimensions In Inches	
	Min	Max	Min	Max
A		1.750		0.069
A ₁	0.100	0.250	0.004	0.010
A ₂	1.250	1.450	0.049	0.057
A ₃	0.25		0.010	
b _p	0.360	0.490	0.014	0.019
c	0.190	0.250	0.007	0.010
D ^(A)	8.550	8.750	0.340	0.350
E ^(A)	3.800	4.000	0.150	0.160
H _E	5.800	6.200	0.228	0.244
e	1.270		0.050	
L	1.05		0.041	
L _P	0.400	1.000	0.016	0.039
Q	0.600	0.700	0.024	0.028
Z ^(A)	0.300	0.700	0.012	0.028
y	0.1		0.004	
θ	0°	8°	0°	8°

NOTE:

- A. Plastic or metal protrusions of 0.15mm maximum per side are not included.
- B. Plastic interlead protrusions of 0.25mm maximum per side are not included.
- C. All linear dimension is in millimeters.
- D. This drawing is subject to change without notice.
- E. Body dimensions do not include mold flash or protrusion. Mold flash and protrusion shall not exceed 0.15 per side.
- F. BSC: Basic Dimension. Theoretically exact value shown without tolerances.

12 TAPE AND REEL INFORMATION

REEL DIMENSIONS

TAPE DIMENSION

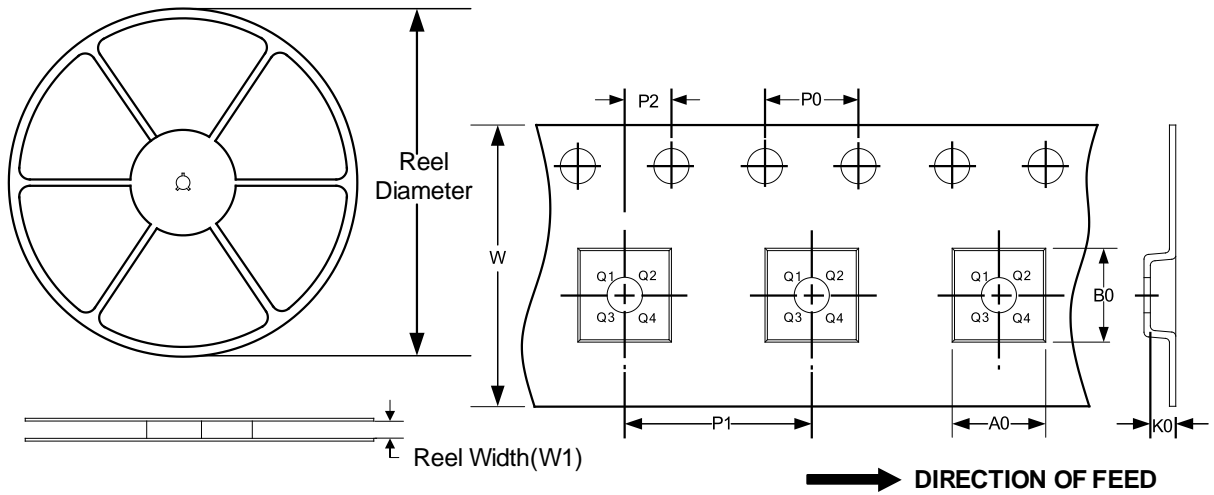

NOTE: The picture is only for reference. Please make the object as the standard.

KEY PARAMETER LIST OF TAPE AND REEL

Package Type	Reel Diameter	Reel Width (mm)	A0 (mm)	B0 (mm)	K0 (mm)	P0 (mm)	P1 (mm)	P2 (mm)	W (mm)	Pin1 Quadrant
SOT23-5	7"	9.5	3.20	3.20	1.40	4.0	4.0	2.0	8.0	Q3
MSOP8	13"	12.4	5.20	3.30	1.50	4.0	8.0	2.0	12.0	Q1
TSSOP14	13"	12.4	6.95	5.60	1.20	4.0	8.0	2.0	12.0	Q1
SOIC-8 (SOP8)	13"	12.4	6.40	5.40	2.10	4.0	8.0	2.0	12.0	Q1
SOIC-14 (SOP14)	13"	16.4	6.60	9.30	2.10	4.0	8.0	2.0	16.0	Q1

NOTE:

1. All dimensions are nominal.
2. Plastic or metal protrusions of 0.15mm maximum per side are not included.

IMPORTANT NOTICE AND DISCLAIMER

Jiangsu Runic Technology Co., Ltd. will accurately and reliably provide technical and reliability data (including data sheets), design resources (including reference designs), application or other design advice, WEB tools, safety information and other resources, without warranty of any defect, and will not make any express or implied warranty, including but not limited to the warranty of merchantability Implied warranty that it is suitable for a specific purpose or does not infringe the intellectual property rights of any third party.

These resources are intended for skilled developers designing with Runic products You will be solely responsible for: (1) Selecting the appropriate products for your application; (2) Designing, validating and testing your application; (3) Ensuring your application meets applicable standards and any other safety, security or other requirements; (4) Runic and the Runic logo are registered trademarks of Runic Incorporated. All trademarks are the property of their respective owners; (5) For change details, review the revision history included in any revised document. The resources are subject to change without notice. Our company will not be liable for the use of this product and the infringement of patents or third-party intellectual property rights due to its use.