

100kHz, 670nA, Non-Unity Gain, Rail-to-Rail I/O CMOS Operational Amplifier

1 FEATURES

- **GAIN BANDWIDTH:100kHz**
- **RAIL-TO-RAIL INPUT AND OUTPUT**
±1mV Typical Vos
- **INPUT VOLTAGE RANGE: -0.1V to +5.6V**
with Vs = 5.5V
- **SUPPLY RANGE: +1.4V to +5.5V**
- **STABLE FOR GAINS ≥ 10**
- **SPECIFIED UP TO +125°C**
- **Micro SIZE PACKAGES: SOT23-5**

2 APPLICATIONS

- **SENSORS**
- **PHOTODIODE AMPLIFICATION**
- **WEARABLE PRODUCTS**
- **TEMPERATURE MEASUREMENT**
- **BATTERY POWERED SYSTEM**

3 DESCRIPTIONS

The RS8051, RS8052, RS8054, families of products offer low voltage operation and rail-to-rail input and output, as well as excellent speed/power consumption ratio, providing an excellent bandwidth (100kHz) and slew rate of 30V/ms. The op-amps are stable for gains ≥ 10 and feature an ultra-low input bias current.

The devices are ideal for sensor interfaces, active filters and portable applications. The RS8051, RS8052, RS8054 families of operational amplifiers are specified at the full temperature range of -40°C to +125°C under single or dual power supplies of 1.4V to 5.5V.

Device Information (1)

PART NUMBER	PACKAGE	BODY SIZE(NOM)
RS8051	SOT23-5	2.90mm×1.60mm
	SOIC-8(SOP8)	4.90mm×3.90mm
	MSOP-8	3.00mm×3.00mm
RS8052	SOIC-8(SOP8)	4.90mm×3.90mm
	MSOP-8	3.00mm×3.00mm
	TDFN2X2-8L	2.00mm×2.00mm
RS8054	SOIC-14 (SOP14)	8.65mm×3.90mm
	TSSOP-14	5.00mm×4.40mm

(1) For all available packages, see the orderable addendum at the end of the data sheet.

Table of Contents

1 FEATURES	1
2 APPLICATIONS	1
3 DESCRIPTIONS	1
4 Revision History	3
5 PACKAGE/ORDERING INFORMATION ⁽¹⁾	4
6 Pin Configuration and Functions (Top View)	5
7 SPECIFICATIONS	7
7.1 Absolute Maximum Ratings	7
7.2 ESD Ratings.....	7
7.3 Recommended Operating Conditions.....	7
7.4 ELECTRICAL CHARACTERISTICS.....	8
7.5 TYPICAL CHARACTERISTICS.....	9
8 PACKAGE OUTLINE DIMENSIONS	10
9 TAPE AND REEL INFORMATION	16

4 Revision History

Note: Page numbers for previous revisions may differ from page numbers in the current version.

Version	Change Date	Change Item
C.1	2023/03/03	1. Update Package Qty on Page 2@RevB.3 2. Added TAPE AND REEL INFORMATION

5 PACKAGE/ORDERING INFORMATION ⁽¹⁾

Orderable Device	Package Type	Pin	Channel	Op Temp(°C)	Device Marking ⁽²⁾	Package Qty
RS8051XF	SOT23-5	5	1	-40°C ~125°C	8051	Tape and Reel,3000
RS8051BXF	SOT23-5	5	1	-40°C ~125°C	8051B	Tape and Reel,3000
RS8051XK	SOIC-8(SOP8)	8	1	-40°C ~125°C	RS8051	Tape and Reel,4000
RS8051XM	MSOP-8	8	1	-40°C ~125°C	RS8051	Tape and Reel,4000
RS8052XK	SOIC-8(SOP8)	8	2	-40°C ~125°C	RS8052	Tape and Reel,4000
RS8052XM	MSOP-8	8	2	-40°C ~125°C	RS8052	Tape and Reel,4000
RS8052XTDE8	DFN2x2-8L	8	2	-40°C ~125°C	8052	Tape and Reel,3000
RS8054XP	SOIC-14(SOP14)	14	4	-40°C ~125°C	RS8054	Tape and Reel,4000
RS8054XQ	TSSOP-14	14	4	-40°C ~125°C	RS8054	Tape and Reel,4000

NOTE:

- (1) This information is the most current data available for the designated devices. This data is subject to change without notice and revision of this document. For browser-based versions of this data sheet, refer to the right-hand navigation.
- (2) There may be additional marking, which relates to the lot trace code information (data code and vendor code), the logo or the environmental category on the device.

6 Pin Configuration and Functions (Top View)

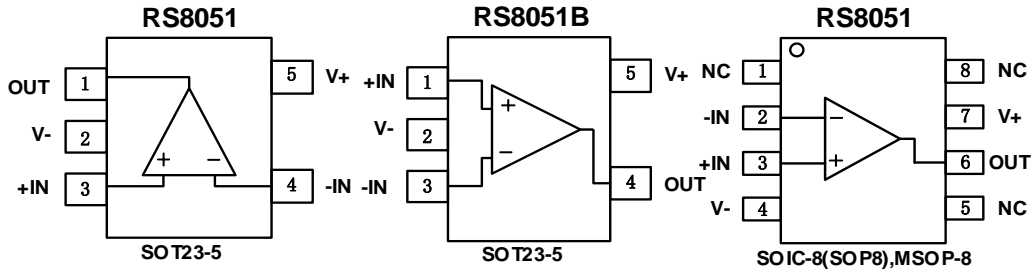

Pin Description

NAME	PIN			I/O ⁽¹⁾	DESCRIPTION
	RS8051	RS8051B	RS8051		
	SOT23-5	SOT23-5	SOIC-8(SOP8) /MSOP8		
-IN	4	3	2	I	Negative (inverting) input
+IN	3	1	3	I	Positive (noninverting) input
NC ⁽²⁾	-	-	1,5,8	-	No internal connection (can be left floating)
OUT	1	4	6	O	Output
V-	2	2	4	-	Negative (lowest) power supply
V+	5	5	7	-	Positive (highest) power supply

(1) I = Input, O = Output.

(2) There is no internal connection. Typically, GND is the recommended connection to a heat spreading plane.

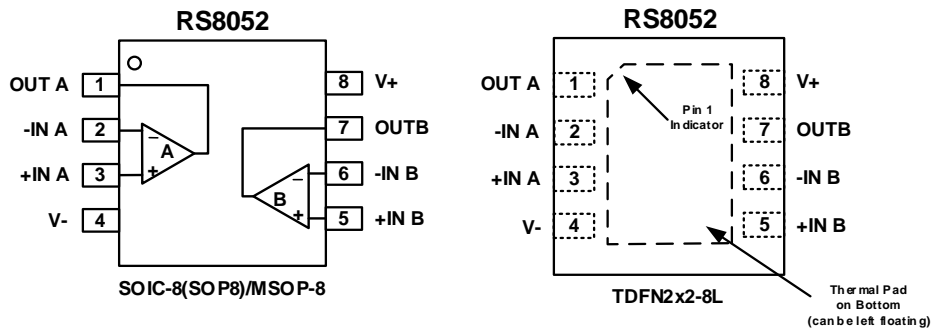

Pin Description

NAME	PIN		I/O ⁽¹⁾	DESCRIPTION
	SOIC-8(SOP8)/MSOP8/TDFN2X2-8L			
-INA	2		I	Inverting input, channel A
+INA	3		I	Noninverting input, channel A
-INB	6		I	Inverting input, channel B
+INB	5		I	Noninverting input, channel B
OUTA	1		O	Output, channel A
OUTB	7		O	Output, channel B
V-	4		-	Negative (lowest) power supply
V+	8		-	Positive (highest) power supply
-	Thermal Pad		-	Connect thermal pad to V-

(1) I = Input, O = Output.

Pin Configuration and Functions (Top View)

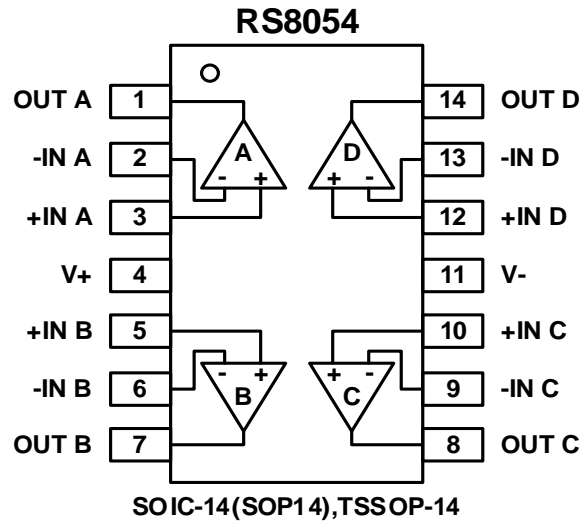

Pin Description

NAME	PIN	I/O ⁽¹⁾	DESCRIPTION
	SOIC-14(SOP14)/TSSOP-14		
-INA	2	I	Inverting input, channel A
+INA	3	I	Noninverting input, channel A
-INB	6	I	Inverting input, channel B
+INB	5	I	Noninverting input, channel B
-INC	9	I	Inverting input, channel C
+INC	10	I	Noninverting input, channel C
-IND	13	I	Inverting input, channel D
+IND	12	I	Noninverting input, channel D
OUTA	1	O	Output, channel A
OUTB	7	O	Output, channel B
OUTC	8	O	Output, channel C
OUTD	14	O	Output, channel D
V-	11	-	Negative (lowest) power supply
V+	4	-	Positive (highest) power supply

(1) I = Input, O = Output.

7 SPECIFICATIONS

7.1 Absolute Maximum Ratings

Over operating free-air temperature range (unless otherwise noted) ⁽¹⁾

		MIN	MAX	UNIT
Voltage	Supply, $V_S=(V+) - (V-)$		7	V
	Signal input pin ⁽²⁾	(V-)-0.5	(V+) +0.5	
	Signal output pin ⁽³⁾	(V-)-0.5	(V+) +0.5	
Current	Signal input pin ⁽²⁾	-10	10	mA
	Signal output pin ⁽³⁾	-55	55	mA
	Output short-circuit ⁽⁴⁾	Continuous		
θ_{JA}	Package thermal impedance ⁽⁵⁾	SOT23-5	230	°C/W
		SOIC-8(SOP8)	110.88	
		MSOP-8	165.7	
		SOIC-14(SOP14)	104.5	
		TSSOP-14	89.21	
		TDFN2x2-8L	80	
Temperature	Operating range, T_A	-40	125	°C
	Junction, T_J ⁽⁶⁾	-40	150	
	Storage, T_{stg}	-65	150	

(1) Stresses above these ratings may cause permanent damage. Exposure to absolute maximum conditions for extended periods may degrade device reliability. These are stress ratings only, and functional operation of the device at these or any other conditions beyond those specified is not implied.

(2) Input terminals are diode-clamped to the power-supply rails. Input signals that can swing more than 0.5V beyond the supply rails should be current-limited to 10mA or less.

(3) Output terminals are diode-clamped to the power-supply rails. Output signals that can swing more than 0.5V beyond the supply rails should be current-limited to ± 55 mA or less.

(4) Short-circuit to ground, one amplifier per package.

(5) The package thermal impedance is calculated in accordance with JESD-51.

(6) The maximum power dissipation is a function of $T_{J(MAX)}$, $R_{\theta JA}$, and T_A . The maximum allowable power dissipation at any ambient temperature is $P_D = (T_{J(MAX)} - T_A) / R_{\theta JA}$. All numbers apply for packages soldered directly onto a PCB.

7.2 ESD Ratings

The following ESD information is provided for handling of ESD-sensitive devices in an ESD protected area only.

			VALUE	UNIT
$V_{(ESD)}$	Electrostatic discharge	Human-body model (HBM), per ANSI/ESDA/JEDEC JS-001 ⁽¹⁾	± 5000	V
		Machine Model (MM)	± 400	

(1) JEDEC document JEP155 states that 500 V HBM allows safe manufacturing with a standard ESD control process.



ESD SENSITIVITY CAUTION

ESD damage can range from subtle performance degradation to complete device failure. Precision integrated circuits may be more susceptible to damage because very small parametric changes could cause the device not to meet its published specifications.

7.3 Recommended Operating Conditions

Over operating free-air temperature range (unless otherwise noted)

		MIN	NOM	MAX	UNIT
Supply voltage, $V_S=(V+) - (V-)$	Single-supply	1.4		5.5	V
	Dual-supply	± 0.7		± 2.75	

7.4 ELECTRICAL CHARACTERISTICS

(At $T_A=+25^\circ\text{C}$, $V_S=5.0\text{V}$, $R_L=1\text{M}\Omega$ connected to $V_S/2$, and $V_{OUT}=V_S/2$, Full ⁽⁹⁾ = -40°C to $+125^\circ\text{C}$, unless otherwise noted.) ⁽¹⁾

PARAMETER		CONDITIONS	T_J	RS8051, RS8052, RS8054			
				MIN ⁽²⁾	TYP ⁽³⁾	MAX ⁽²⁾	UINT
POWER SUPPLY							
V_S	Operating Voltage Range		25°C	1.4		5.5	V
I_Q	Quiescent Current/Amplifier		25°C		670	1500	nA
PSRR	Power-Supply Rejection Ratio	$V_S=1.4\text{V to }5.5\text{V}$, $V_{CM}=(V_-)+0.5\text{V}$	25°C	60	70		dB
INPUT							
V_{OS}	Input Offset Voltage	$V_{CM}=V_S/2$	25°C	-5	± 1	5	mV
$V_{OS} T_C$	Input Offset Voltage Average Drift	$V_{CM}=V_S/2$	Full		± 2.3		$\mu\text{V}/^\circ\text{C}$
IB	Input Bias Current ⁽⁴⁾ ⁽⁵⁾		25°C		± 1	± 10	pA
I_{OS}	Input Offset Current ⁽⁴⁾		25°C		± 1	± 10	pA
V_{CM}	Common-Mode Voltage Range	$V_S=5.5\text{V}$	25°C	-0.1		5.6	V
CMRR	Common-Mode Rejection Ratio	$V_S=5.5\text{V}$, $V_{CM}=-0.1\text{V to }4\text{V}$	25°C	63	75		dB
		$V_S=5.5\text{V}$, $V_{CM}=-0.1\text{V to }5.6\text{V}$	25°C	58	70		dB
OUTPUT							
A_{OL}	Open-Loop Voltage Gain	$V_S=1.4\text{V}$, $R_L=50\text{k}\Omega$, $V_O=V_S-0.1\text{V}$	25°C	62	80		dB
		$V_S=5.0\text{V}$, $R_L=50\text{k}\Omega$, $V_O=V_S-0.1\text{V}$	25°C	65	85		dB
	Output Swing From Rail	$R_L=50\text{k}\Omega$	25°C		5		mV
I_{OUT}	Output Short-Circuit Current ⁽⁶⁾ ⁽⁷⁾		25°C		± 30		mA
FREQUENCY RESPONSE							
SR	Slew Rate ⁽⁸⁾		25°C		30		V/ms
GBP	Gain-Bandwidth Product		25°C		100		kHz
PM	Phase Margin		25°C		60		$^\circ$
NOISE							
$e_{n\text{p-p}}$	Input Voltage Noise	$f = 0.1\text{ Hz to }10\text{ Hz}$	25°C		2.4		μVpp
e_n	Input Voltage Noise Density	$f = 1\text{ kHz}$	25°C		160		$\text{nV}/\sqrt{\text{Hz}}$

NOTE:

- (1) Electrical table values apply only for factory testing conditions at the temperature indicated. Factory testing conditions result in very limited self-heating of the device.
- (2) Limits are 100% production tested at 25°C . Limits over the operating temperature range are ensured through correlations using statistical quality control (SQC) method.
- (3) Typical values represent the most likely parametric norm as determined at the time of characterization. Actual typical values may vary over time and will also depend on the application and configuration.
- (4) This parameter is ensured by design and/or characterization and is not tested in production.
- (5) Positive current corresponds to current flowing into the device.
- (6) The maximum power dissipation is a function of $T_{J(\text{MAX})}$, $R_{\theta\text{JA}}$, and T_A . The maximum allowable power dissipation at any ambient temperature is $PD = (T_{J(\text{MAX})} - T_A) / R_{\theta\text{JA}}$. All numbers apply for packages soldered directly onto a PCB.
- (7) Short circuit test is a momentary test.
- (8) Number specified is the slower of positive and negative slew rates.
- (9) Specified by characterization only.

7.5 TYPICAL CHARACTERISTICS

NOTE: The graphs and tables provided following this note are a statistical summary based on a limited number of samples and are provided for informational purposes only.

At $T_A = +25^\circ\text{C}$, $V_S = 5\text{V}$, $R_L = 1\text{M}\Omega$ connected to $V_S/2$, $C_L = 60\text{pF}$, $V_{CM} = V_S/2$, unless otherwise noted.

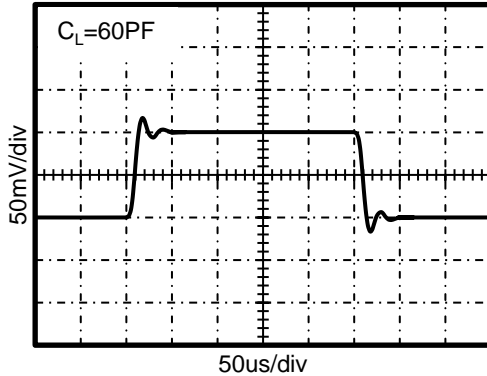

Figure 1. Small-Signal Step Response

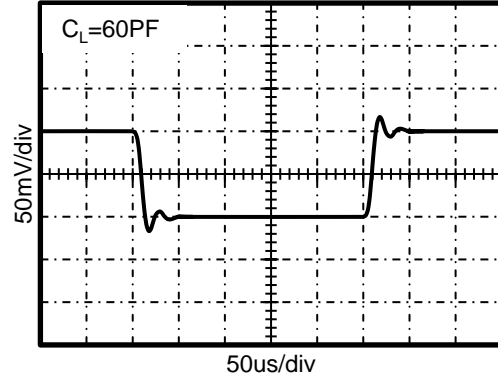

Figure 2. Small-Signal Step Response

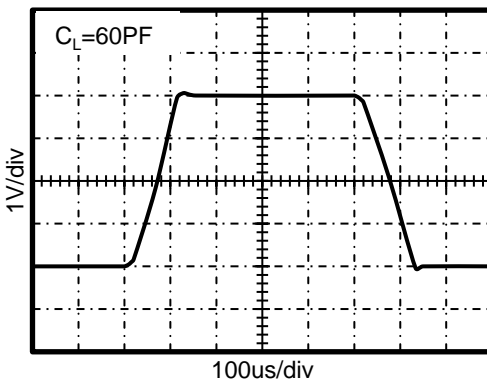

Figure 3. Large-Signal Step Response

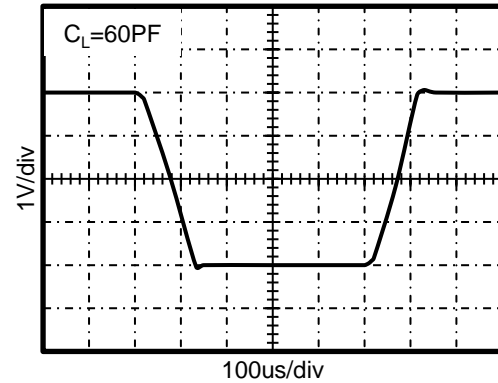

Figure 4. Large-Signal Step Response

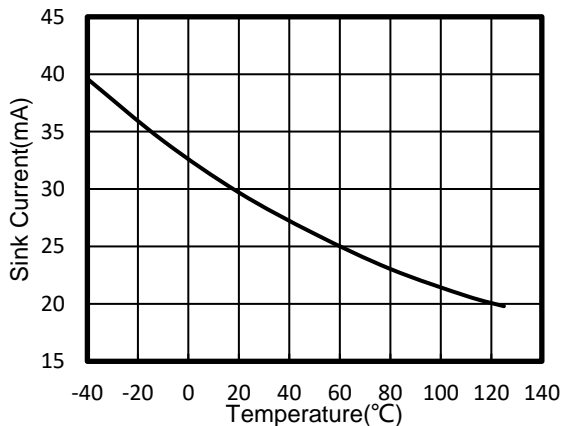

Figure 5. Sink Current vs Temperature

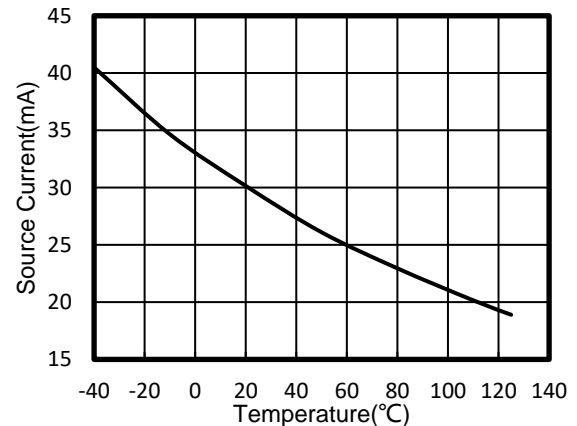
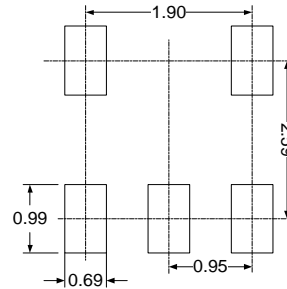
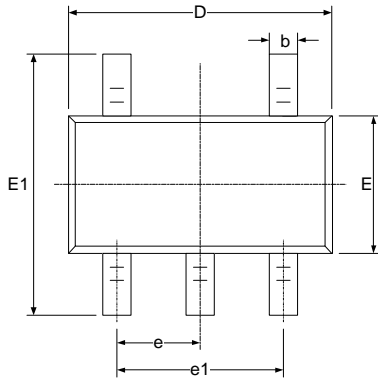
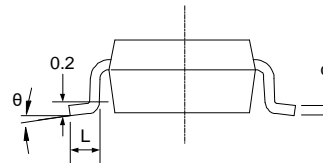
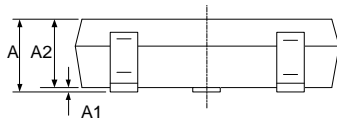
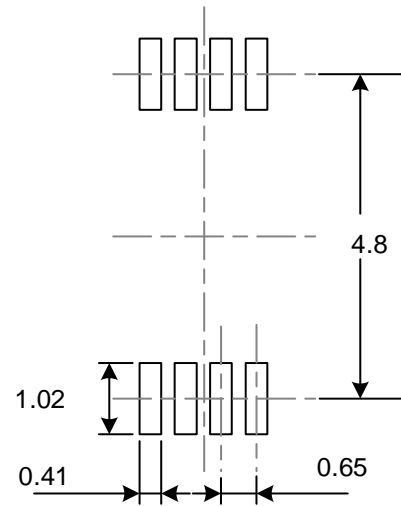
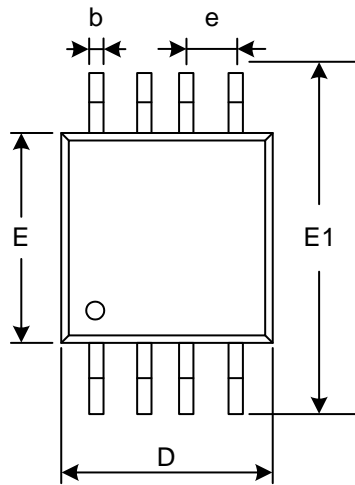
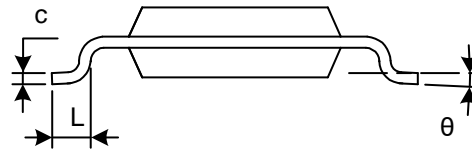
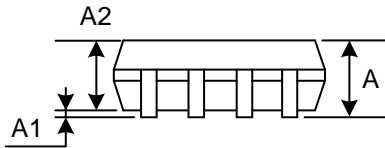

Figure 6. Source Current vs Temperature

**8 PACKAGE OUTLINE DIMENSIONS
SOT23-5**

RECOMMENDED LAND PATTERN (Unit: mm)

Symbol	Dimensions In Millimeters		Dimensions In Inches	
	Min	Max	Min	Max
A	1.050	1.250	0.041	0.049
A1	0.000	0.100	0.000	0.004
A2	1.050	1.150	0.041	0.045
b	0.300	0.500	0.012	0.020
c	0.100	0.200	0.004	0.008
D	2.820	3.020	0.111	0.119
E	1.500	1.700	0.059	0.067
E1	2.650	2.950	0.104	0.116
e	0.950(BSC)		0.037(BSC)	
e1	1.800	2.000	0.071	0.079
L	0.300	0.600	0.012	0.024
θ	0°	8°	0°	8°

MSOP-8

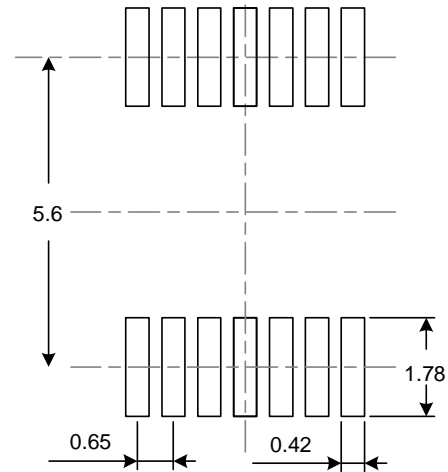
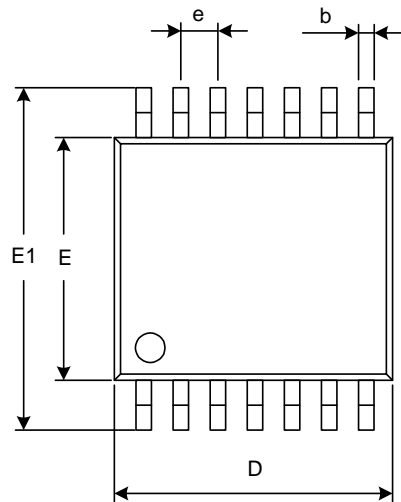
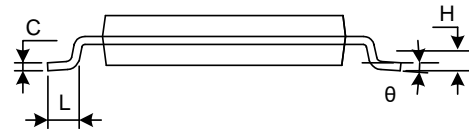
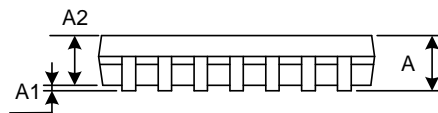
RECOMMENDED LAND PATTERN (Unit: mm)

Symbol	Dimensions In Millimeters		Dimensions In Inches	
	Min	Max	Min	Max
A	0.820	1.100	0.032	0.043
A1	0.020	0.150	0.001	0.006
A2	0.750	0.950	0.030	0.037
b	0.250	0.380	0.010	0.015
c	0.090	0.230	0.004	0.009
D	2.900	3.100	0.114	0.122
e	0.650(BSC)		0.026(BSC)	
E	2.900	3.100	0.114	0.122
E1	4.750	5.050	0.187	0.199
L	0.400	0.800	0.016	0.031
θ	0°	6°	0°	6°

TSSOP-14

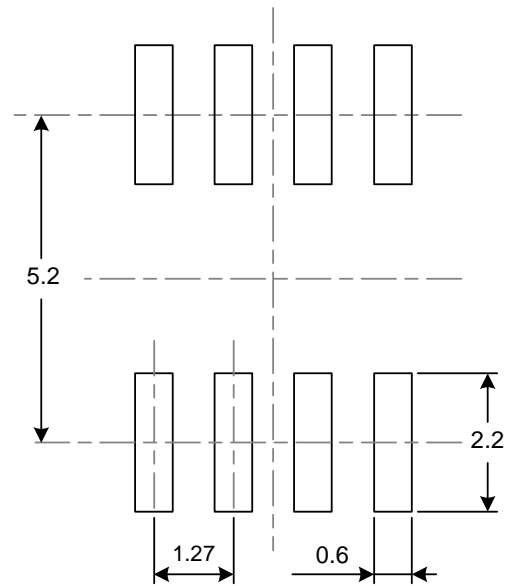
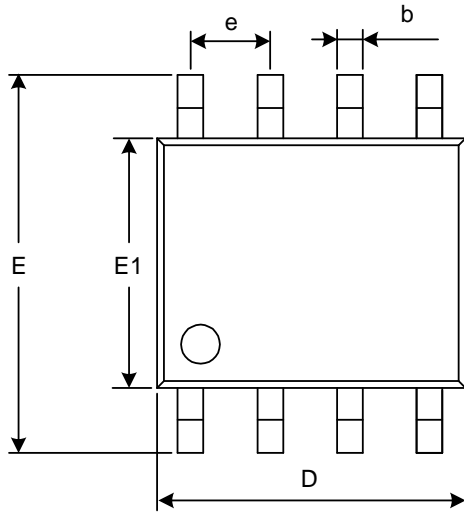
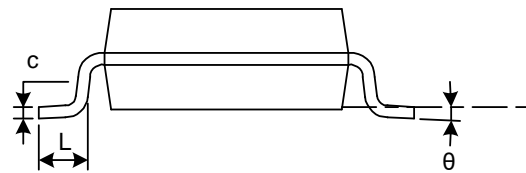
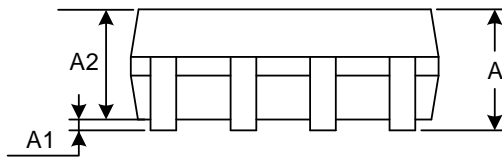
RECOMMENDED LAND PATTERN (Unit: mm)

Symbol	Dimensions In Millimeters		Dimensions In Inches	
	Min	Max	Min	Max
A		1.200		0.047
A1	0.050	0.150	0.002	0.006
A2	0.800	1.050	0.031	0.041
b	0.190	0.300	0.007	0.012
c	0.090	0.200	0.004	0.008
D	4.860	5.100	0.191	0.201
E	4.300	4.500	0.169	0.177
E1	6.250	6.550	0.246	0.258
e	0.650(BSC)		0.026(BSC)	
L	0.500	0.700	0.020	0.028
H	0.25(TYP)		0.01(TYP)	
θ	1°	7°	1°	7°

SOIC-8 (SOP8)

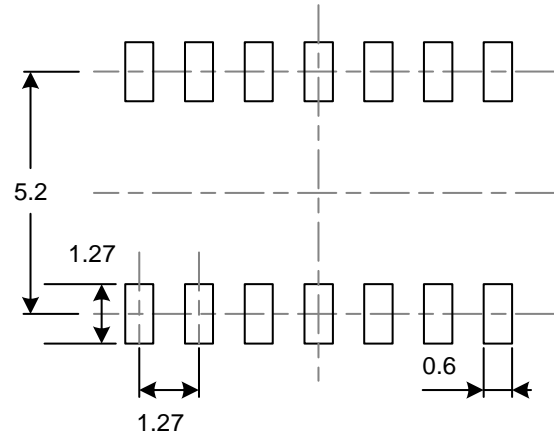
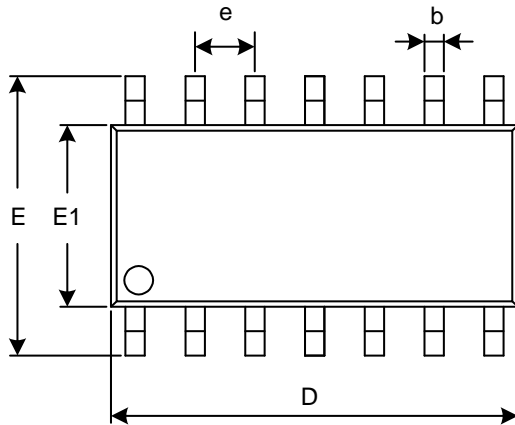
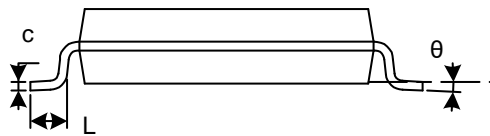
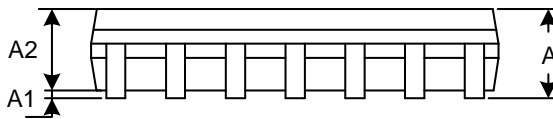
RECOMMENDED LAND PATTERN (Unit: mm)

Symbol	Dimensions In Millimeters		Dimensions In Inches	
	Min	Max	Min	Max
A	1.350	1.750	0.053	0.069
A1	0.100	0.250	0.004	0.010
A2	1.350	1.550	0.053	0.061
b	0.330	0.510	0.013	0.020
c	0.170	0.250	0.007	0.010
D	4.800	5.000	0.189	0.197
e	1.270(BSC)		0.050(BSC)	
E	5.800	6.200	0.228	0.244
E1	3.800	4.000	0.150	0.157
L	0.400	1.270	0.016	0.050
θ	0°	8°	0°	8°

SOIC-14 (SOP14)

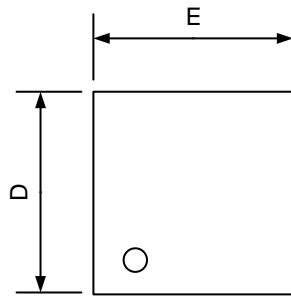
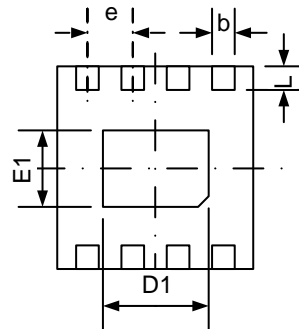
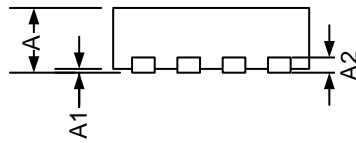
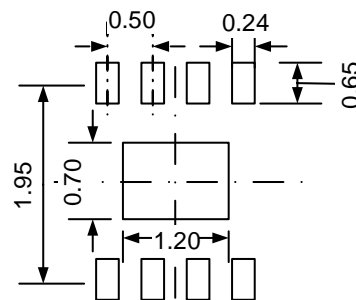
RECOMMENDED LAND PATTERN (Unit: mm)

Symbol	Dimensions In Millimeters		Dimensions In Inches	
	Min	Max	Min	Max
A	1.350	1.750	0.053	0.069
A1	0.100	0.250	0.004	0.010
A2	1.350	1.550	0.053	0.061
b	0.310	0.510	0.012	0.020
c	0.100	0.250	0.004	0.010
D	8.450	8.850	0.333	0.348
e	1.270(BSC)		0.050(BSC)	
E	5.800	6.200	0.228	0.244
E1	3.800	4.000	0.150	0.157
L	0.400	1.270	0.016	0.050
θ	0°	8°	0°	8°

DFN2x2-8L

TOP VIEW

BOTTOM VIEW

SIDE VIEW

RECOMMENDED LAND PATTERN (Unit: mm)

Symbol	Dimensions In Millimeters		Dimensions In Inches	
	Min	Max	Min	Max
A	0.700	0.800	0.028	0.031
A1	0.000	0.050	0.000	0.002
A2	0.203(TYP)		0.008(TYP)	
b	0.180	0.300	0.007	0.012
D	1.900	2.100	0.075	0.083
D1	1.100	1.300	0.043	0.051
E	1.900	2.100	0.075	0.083
E1	0.600	0.800	0.024	0.031
e	0.500(TYP)		0.020(TYP)	
L	0.250	0.450	0.010	0.018

NOTE:

- A. All linear dimension is in millimeters.
- B. This drawing is subject to change without notice.
- C. Body dimensions do not include mold flash or protrusion. Mold flash and protrusion shall not exceed 0.15 per side.
- D. BSC: Basic Dimension. Theoretically exact value shown without tolerances.

9 TAPE AND REEL INFORMATION

REEL DIMENSIONS

TAPE DIMENSION

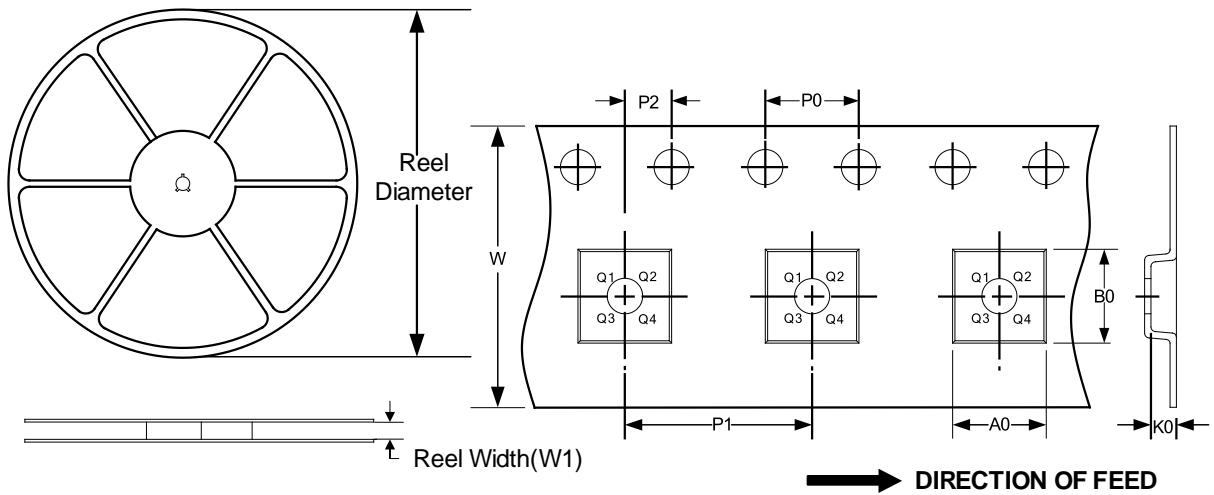

NOTE: The picture is only for reference. Please make the object as the standard.

KEY PARAMETER LIST OF TAPE AND REEL

Package Type	Reel Diameter	Reel Width (mm)	A0 (mm)	B0 (mm)	K0 (mm)	P0 (mm)	P1 (mm)	P2 (mm)	W (mm)	Pin1 Quadrant
SOT23-5	7"	9.5	3.20	3.20	1.40	4.0	4.0	2.0	8.0	Q3
MSOP8	13"	12.4	5.20	3.30	1.50	4.0	8.0	2.0	12.0	Q1
TSSOP14	13"	12.4	6.95	5.60	1.20	4.0	8.0	2.0	12.0	Q1
SOIC-8 (SOP8)	13"	12.4	6.40	5.40	2.10	4.0	8.0	2.0	12.0	Q1
SOIC-14 (SOP14)	13"	16.4	6.60	9.30	2.10	4.0	8.0	2.0	16.0	Q1
DFN2x2-8L	7"	9.5	2.30	2.30	1.10	4.0	4.0	2.0	8.0	Q2

NOTE:

1. All dimensions are nominal.
2. Plastic or metal protrusions of 0.15mm maximum per side are not included.

IMPORTANT NOTICE AND DISCLAIMER

Jiangsu Runic Technology Co., Ltd. will accurately and reliably provide technical and reliability data (including data sheets), design resources (including reference designs), application or other design advice, WEB tools, safety information and other resources, without warranty of any defect, and will not make any express or implied warranty, including but not limited to the warranty of merchantability. Implied warranty that it is suitable for a specific purpose or does not infringe the intellectual property rights of any third party.

These resources are intended for skilled developers designing with Runic products. You will be solely responsible for: (1) Selecting the appropriate products for your application; (2) Designing, validating and testing your application; (3) Ensuring your application meets applicable standards and any other safety, security or other requirements; (4) Runic and the Runic logo are registered trademarks of Runic Incorporated. All trademarks are the property of their respective owners; (5) For change details, review the revision history included in any revised document. The resources are subject to change without notice. Our company will not be liable for the use of this product and the infringement of patents or third-party intellectual property rights due to its use.