

7MHz, Precision, Rail-to-Rail I/O CMOS Operational Amplifier

FEATURES

- **GAIN BANDWIDTH:7MHz**
- **RAIL-TO-RAIL INPUT AND OUTPUT**
±0.5mV Max Vos
- **INPUT VOLTAGE RANGE: -0.1V to +5.6V**
with Vs = 5.5V
- **SUPPLY RANGE: +2.5V to +5.5V**
- **SPECIFIED UP TO +125°C**
- **Micro SIZE PACKAGES: SOT23-5,**
SOT353(SC70-5)

APPLICATIONS

- **SENSORS**
- **PHOTODIODE AMPLIFICATION**
- **ACTIVE FILTERS**
- **TEST EQUIPMENT**
- **DRIVING A/D CONVERTERS**

DESCRIPTION

The RS621P, RS622P, RS624P families of products offer low voltage operation and rail-to-rail input and output, as well as excellent speed/power consumption ratio, providing an excellent bandwidth (7MHz) and slew rate of 3.7V/us. The op-amps are unity gain stable and feature an ultra-low input bias current.

The RS621P, RS622P and RS624P has lower offset, which is guaranteed not upper than ±0.5mV at 25°C with Vs = 5V, V_{CM} = Vs/2.

The devices are ideal for sensor interfaces, active filters and portable applications. The RS621P, RS622P, RS624P families of operational amplifiers are specified at the full temperature range of -40°C to +125°C under single or dual power supplies of 2.5V to 5.5V.

Device Information ⁽¹⁾

PART NUMBER	PACKAGE	BODY SIZE(NOM)
RS621P	SOT23-5	2.90mm×1.60mm
	SOIC-8(SOP8)	4.90mm×3.90mm
	MSOP-8	3.00mm×3.00mm
	SOT353(SC70-5)	2.10mm×1.25mm
RS622P	SOIC-8(SOP8)	4.90mm×3.90mm
	MSOP-8	3.00mm×3.00mm
	TSSOP-8	3.00mm×4.40mm
	TDFN2×2-8L	2.00mm×2.00mm
RS624P	SOIC-14(SOP14)	8.65mm×3.90mm
	TSSOP-14	5.00mm×4.40mm

(1) For all available packages, see the orderable addendum at the end of the data sheet.

Revision History

Note: Page numbers for previous revisions may differ from page numbers in the current version.

VERSION	Change Date	Change Item
C.1	2021/11/11	1.Added the SOT353(SC70-5) package 2.Update Package Qty on Page 2@RevB.4

Pin Configuration and Functions (Top View)

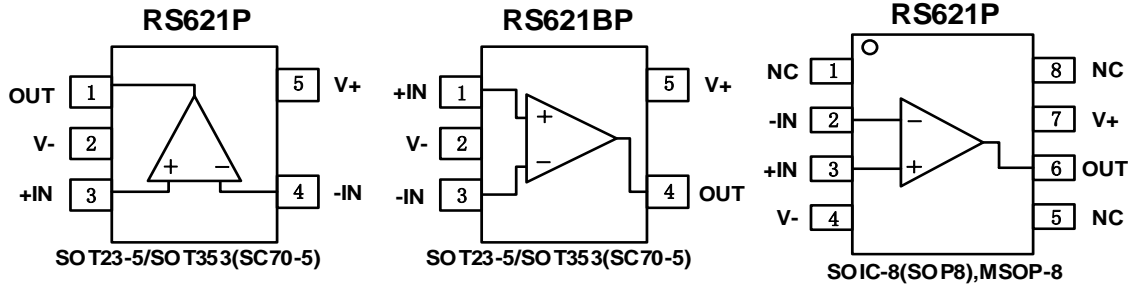

Pin Description

NAME	PIN			I/O	DESCRIPTION
	RS621P	RS621BP	RS621P		
	SOT23-5/ SOT353(SC70-5)	SOT23-5/ SOT353(SC70-5)	SOIC-8(SOP8)/ MSOP8		
-IN	4	3	2	I	Negative (inverting) input
+IN	3	1	3	I	Positive (noninverting) input
NC	-	-	1,5,8	-	No internal connection (can be left floating)
OUT	1	4	6	O	Output
V-	2	2	4	-	Negative (lowest) power supply
V+	5	5	7	-	Positive (highest) power supply

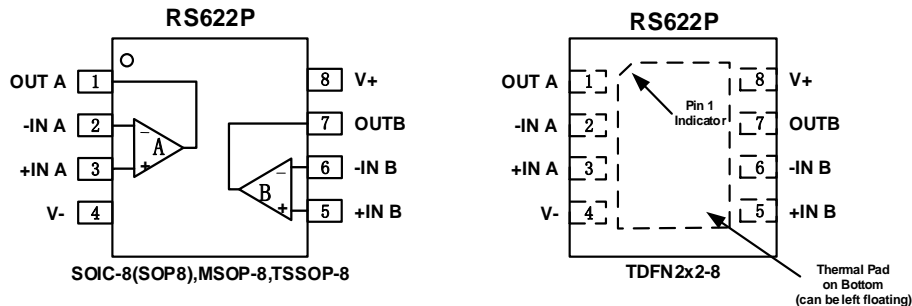

Pin Description

NAME	PIN		I/O	DESCRIPTION
	SOIC-8(SOP8)/MSOP8/TSSOP-8/TDFN2x2-8L			
-INA	2		I	Inverting input, channel A
+INA	3		I	Noninverting input, channel A
-INB	6		I	Inverting input, channel B
+INB	5		I	Noninverting input, channel B
OUTA	1		O	Output, channel A
OUTB	7		O	Output, channel B
V-	4		-	Negative (lowest) power supply
V+	8		-	Positive (highest) power supply

Pin Configuration and Functions (Top View)

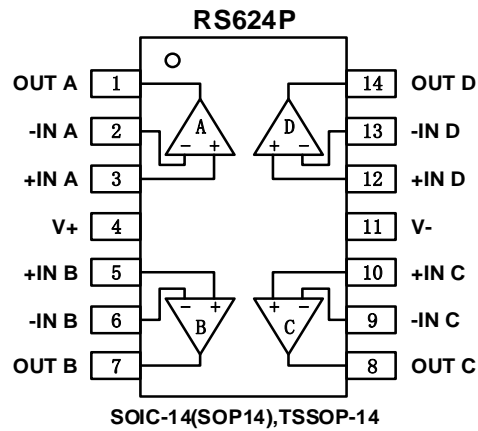

Pin Description

NAME	PIN	I/O	DESCRIPTION
	SOIC-14(SOP14)/TSSOP-14		
-INA	2	I	Inverting input, channel A
+INA	3	I	Noninverting input, channel A
-INB	6	I	Inverting input, channel B
+INB	5	I	Noninverting input, channel B
-INC	9	I	Inverting input, channel C
+INC	10	I	Noninverting input, channel C
-IND	13	I	Inverting input, channel D
+IND	12	I	Noninverting input, channel D
OUTA	1	O	Output, channel A
OUTB	7	O	Output, channel B
OUTC	8	O	Output, channel C
OUTD	14	O	Output, channel D
V-	11	-	Negative (lowest) power supply
V+	4	-	Positive (highest) power supply

SPECIFICATIONS

Absolute Maximum Ratings

Over operating free-air temperature range (unless otherwise noted) ⁽¹⁾

		MIN	MAX	UNIT
Voltage	Supply, $V_s=(V+) - (V-)$		7	V
	Signal input pin ⁽²⁾	(V-)-0.5	(V+) +0.5	
	Signal output pin ⁽³⁾	(V-)-0.5	(V+) +0.5	
Current	Signal input pin ⁽²⁾	-10	10	mA
	Signal output pin ⁽³⁾	-140	140	mA
	Output short-circuit ⁽⁴⁾	Continuous		
Temperature	Operating range, T_A	-40	125	°C
	Junction, T_J		150	
	Storage, T_{stg}	-65	150	

- (1) Stresses above these ratings may cause permanent damage. Exposure to absolute maximum conditions for extended periods may degrade device reliability. These are stress ratings only, and functional operation of the device at these or any other conditions beyond those specified is not implied.
- (2) Input terminals are diode-clamped to the power-supply rails. Input signals that can swing more than 0.5V beyond the supply rails should be current-limited to 10mA or less.
- (3) Output terminals are diode-clamped to the power-supply rails. Output signals that can swing more than 0.5V beyond the supply rails should be current-limited to ± 140 mA or less.
- (4) Short-circuit to ground, one amplifier per package.

ESD Ratings

			VALUE	UNIT
$V_{(ESD)}$	Electrostatic discharge	Human-body model (HBM)	± 3000	V
		Machine Model (MM)	± 200	

Recommended Operating Conditions

Over operating free-air temperature range (unless otherwise noted)

		MIN	NOM	MAX	UNIT
Supply voltage , $V_s=(V+) - (V-)$	Single-supply	2.5		5.5	V
	Dual-supply	± 1.25		± 2.75	

Thermal Information: RS621P

THERMAL METRIC		RS621P				UNIT
		5PINS		8PINS		
		SOT23-5	SOT353(SC70-5)	SOIC-8	MSOP8	
$R_{\theta JA}$	Junction-to-ambient thermal resistance	273.8	214.7	116	165	°C/W
$R_{\theta JC(top)}$	Junction-to-case(top) thermal resistance	126.8	127.1	60	53	°C/W
$R_{\theta JB}$	Junction-to-board thermal resistance	85.9	60.0	56	87	°C/W
Ψ_{JT}	Junction-to-top characterization parameter	10.9	33.4	12.8	4.9	°C/W
Ψ_{JB}	Junction-to-board characterization parameter	84.9	59.8	98.3	85	°C/W
$R_{\theta JC(bot)}$	Junction-to-case(bottom) thermal resistance	N/A	N/A	N/A	N/A	°C/W

Thermal Information: RS622P

THERMAL METRIC		RS622P				UNIT
		8PINS				
		SOIC-8	MSOP8	TSSOP-8	TDFN2x2-8L	
R _{θJA}	Junction-to-ambient thermal resistance	116	165	192	80.1	°C/W
R _{θJC(top)}	Junction-to-case(top) thermal resistance	60	53	64.3	100	°C/W
R _{θJB}	Junction-to-board thermal resistance	56	87	105.3	45	°C/W
Ψ _{JT}	Junction-to-top characterization parameter	12.8	4.9	7.6	6.8	°C/W
Ψ _{JB}	Junction-to-board characterization parameter	98.3	85	105.5	45.2	°C/W
R _{θJC(bot)}	Junction-to-case(bottom) thermal resistance	N/A	N/A	N/A	22.7	°C/W

Thermal Information: RS624P

THERMAL METRIC		RS624P		UNIT
		14PINS		
		SOIC-14	TSSOP-14	
R _{θJA}	Junction-to-ambient thermal resistance	83.8	205.8	°C/W
R _{θJC(top)}	Junction-to-case(top) thermal resistance	70.7	106.7	°C/W
R _{θJB}	Junction-to-board thermal resistance	59.5	133.9	°C/W
Ψ _{JT}	Junction-to-top characterization parameter	11.6	34.4	°C/W
Ψ _{JB}	Junction-to-board characterization parameter	37.7	132.6	°C/W
R _{θJC(bot)}	Junction-to-case(bottom) thermal resistance	N/A	N/A	°C/W

PACKAGE/ORDERING INFORMATION

Orderable Device	Package Type	Pin	Channel	Op Temp(°C)	Device Marking	Package Qty
RS621PXF	SOT23-5	5	1	-40°C~125°C	621P	Tape and Reel,3000
RS621PXC5	SOT353(SC70-5)	5	1	-40°C~125°C	621P	Tape and Reel,3000
RS621BPXF	SOT23-5	5	1	-40°C~125°C	621BP	Tape and Reel,3000
RS621BPXC5	SOT353(SC70-5)	5	1	-40°C~125°C	621BP	Tape and Reel,3000
RS621PXK	SOIC-8(SOP8)	8	1	-40°C~125°C	RS621P	Tape and Reel,4000
RS621PXM	MSOP-8	8	1	-40°C~125°C	RS621P	Tape and Reel,4000
RS622PXK	SOIC-8(SOP8)	8	2	-40°C~125°C	RS622P	Tape and Reel,4000
RS622PXM	MSOP-8	8	2	-40°C~125°C	RS622P	Tape and Reel,4000
RS622PXQ	TSSOP-8	8	2	-40°C~125°C	RS622P	Tape and Reel,4000
RS622PXTDE8	TDFN2x2-8L	8	2	-40°C~125°C	RS622P	Tape and Reel,3000
RS624PXP	SOIC-14(SOP14)	14	4	-40°C~125°C	RS624P	Tape and Reel,4000
RS624PXQ	TSSOP-14	14	4	-40°C~125°C	RS624P	Tape and Reel,4000

ELECTRICAL CHARACTERISTICS

(At $T_A = +25^\circ\text{C}$, $V_S = 5\text{V}$, $R_L = 10\text{k}\Omega$ connected to $V_S/2$, and $V_{OUT} = V_S/2$, unless otherwise noted.)

PARAMETER	CONDITIONS	T_J	RS621P, RS622P, RS624P				
			MIN	TYP	MAX	UNITS	
POWER SUPPLY							
V_S	Operating Voltage Range	25°C	2.5		5.5		V
I_Q	Quiescent Current/Amplifier	25°C		720	1000		μA
PSRR	Power-Supply Rejection Ratio	$V_S = 2.5\text{V to } 5.5\text{V}$, $V_{CM} = (V_S) + 0.5\text{V}$	25°C	75	96		dB
			$-40^\circ\text{C to } 125^\circ\text{C}$	67			
t_{ON}	Turn-on Time	25°C		12			μs
INPUT							
V_{OS}	Input Offset Voltage	$V_{CM} = V_S/2$	25°C	-0.5	± 0.3	0.5	mV
$V_{OS} T_C$	Input offset voltage drift	$-40^\circ\text{C to } 125^\circ\text{C}$			± 2		$\mu\text{V}/^\circ\text{C}$
I_B	Input Bias Current		25°C		± 1	± 10	pA
I_{OS}	Input Offset Current		25°C		± 1	± 10	pA
V_{CM}	Common-Mode Voltage Range	$V_S = 5.5\text{V}$	25°C	-0.1		5.6	V
CMRR	Common-Mode Rejection Ratio	$V_S = 5.5\text{V}$, $V_{CM} = -0.2\text{V to } 4\text{V}$	25°C	75	96		dB
			$-40^\circ\text{C to } 125^\circ\text{C}$	65			
		$V_S = 5.5\text{V}$, $V_{CM} = -0.1\text{V to } 5.6\text{V}$	25°C	64	81		
			$-40^\circ\text{C to } 125^\circ\text{C}$	57			
OUTPUT							
A_{OL}	Open-Loop Voltage Gain	$R_L = 10\text{k}\Omega$, $V_O = 0.015\text{V to } 4.985\text{V}$	25°C	100	110		dB
			$-40^\circ\text{C to } 125^\circ\text{C}$	87			
		$R_L = 2\text{k}\Omega$, $V_O = 0.1\text{V to } 4.9\text{V}$	25°C	95	105		
			$-40^\circ\text{C to } 125^\circ\text{C}$	80			
	Output Swing From Rail	$R_L = 2\text{k}\Omega$	25°C		40		mV
		$R_L = 10\text{k}\Omega$			10		
I_{OUT}	Output Current Source		25°C		120		mA
FREQUENCY RESPONSE							
SR	Slew Rate		25°C		3.7		V/ μs
GBP	Gain-Bandwidth Product		25°C		7		MHz
PM	Phase Margin		25°C		64		$^\circ$
t_s	Setting Time, 0.1%		25°C		0.5		μs
t_{OR}	Overload recovery time	$V_{IN} \times G = V_S, G = -100$	25°C		1		μs
NOISE							
e_n	Input Voltage Noise Density	$f = 1\text{KHz}$	25°C		11		nV/ $\sqrt{\text{Hz}}$
		$f = 10\text{KHz}$	25°C		7.5		nV/ $\sqrt{\text{Hz}}$

TYPICAL CHARACTERISTICS

At $T_A = +25^\circ\text{C}$, $V_S = 5\text{V}$, $R_L = 10\text{k}\Omega$ connected to $V_S/2$, $V_{OUT} = V_S/2$, unless otherwise noted.

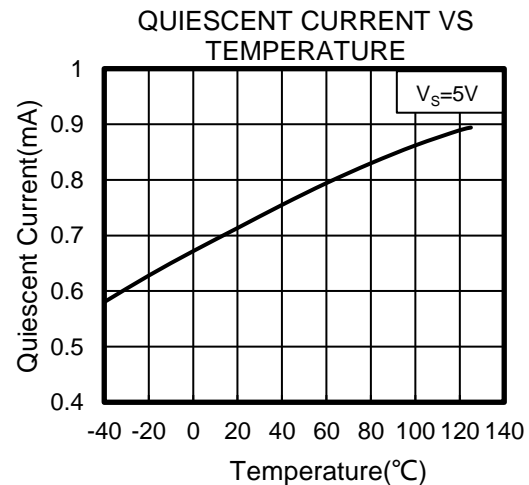
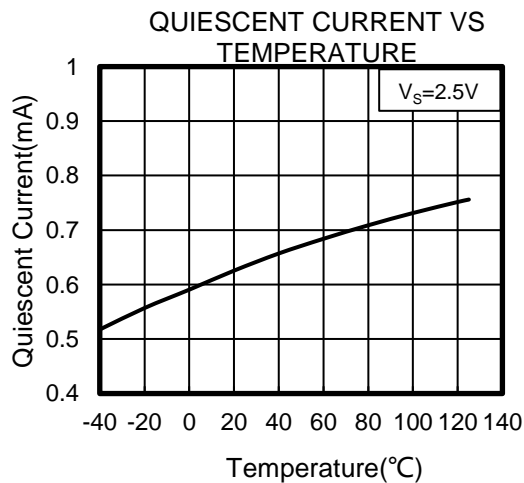
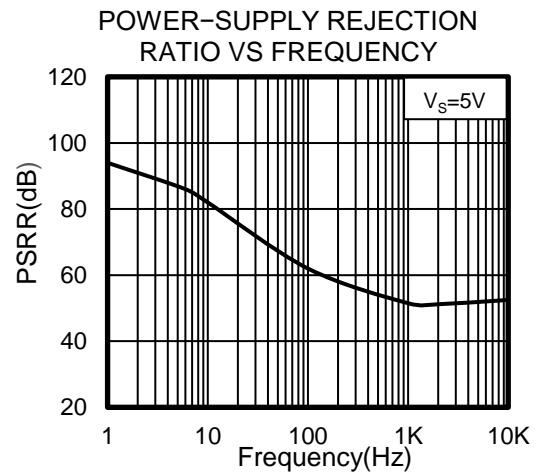
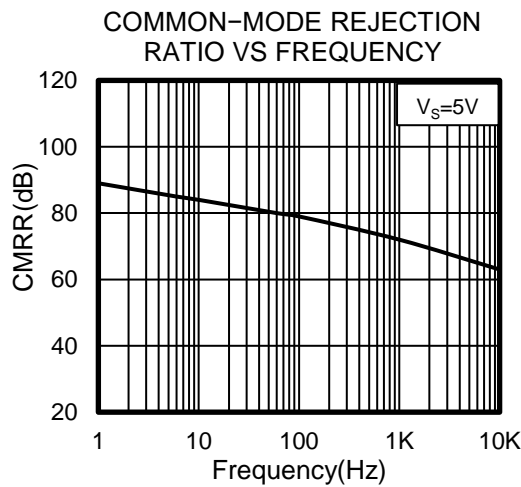
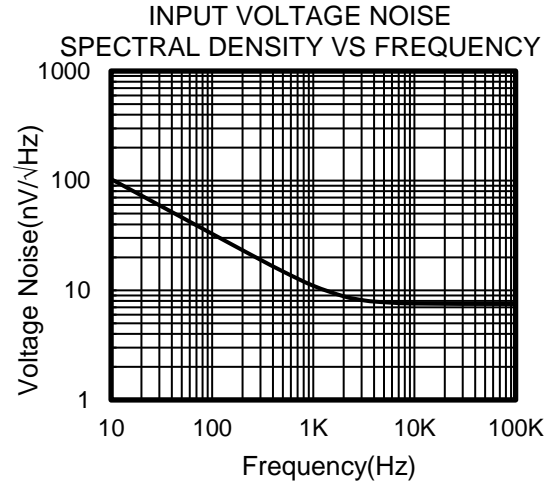
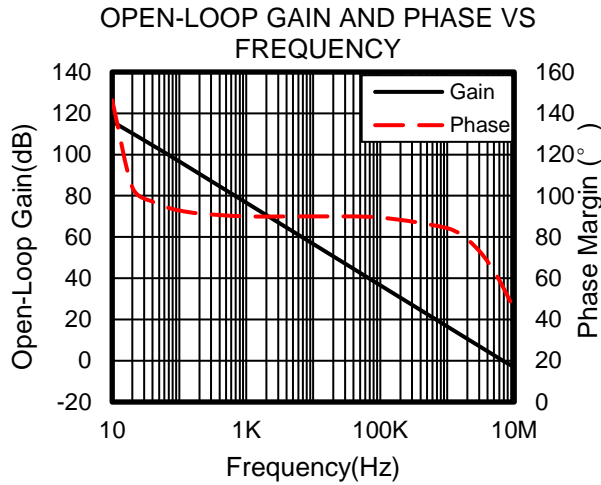

TYPICAL CHARACTERISTICS

At $T_A = +25^\circ\text{C}$, $V_S = 5\text{V}$, $R_L = 10\text{k}\Omega$ connected to $V_S/2$, $V_{OUT} = V_S/2$, unless otherwise noted.

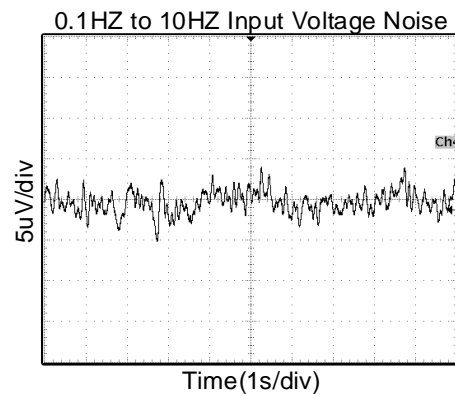
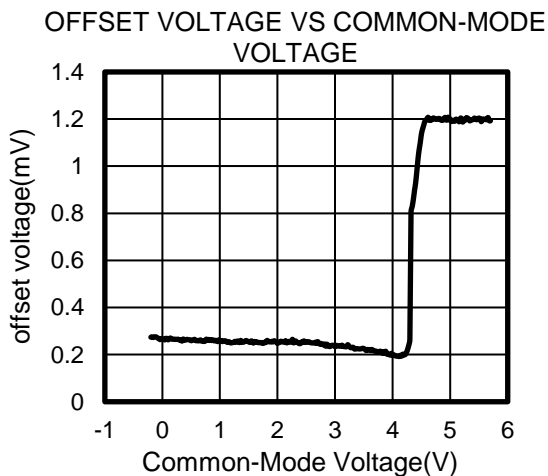
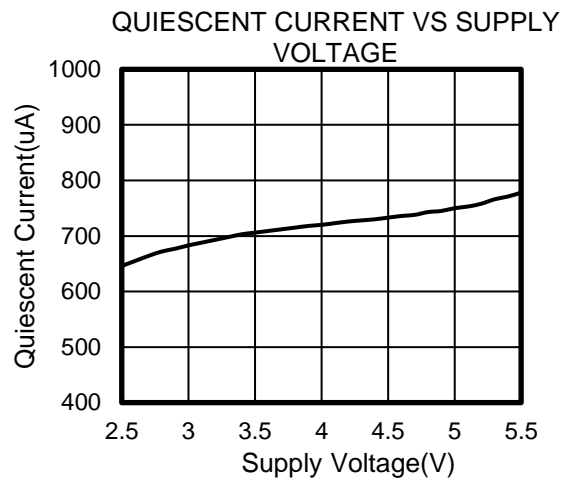
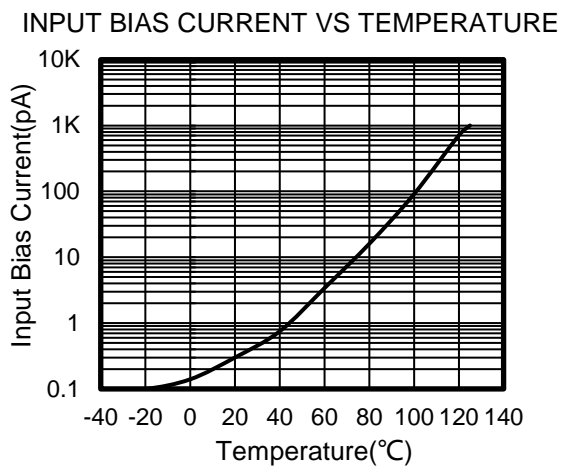
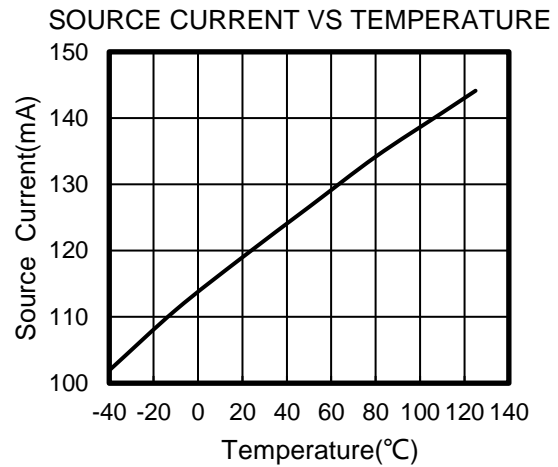
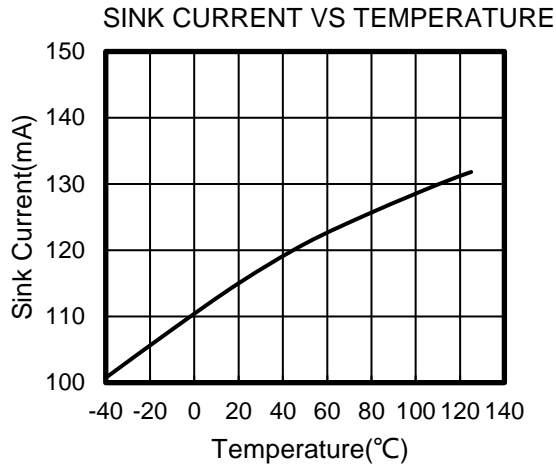

TYPICAL CHARACTERISTICS

At $T_A = +25^\circ\text{C}$, $V_S = 5\text{V}$, $R_L = 10\text{k}\Omega$ connected to $V_S/2$, $V_{OUT} = V_S/2$, unless otherwise noted.

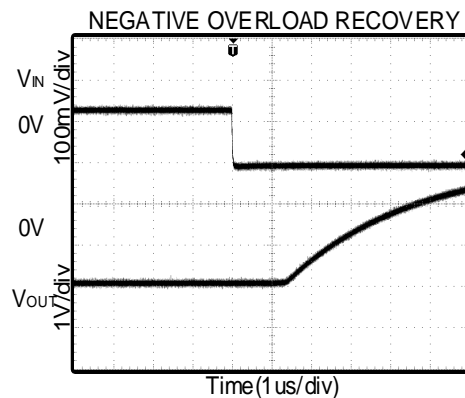
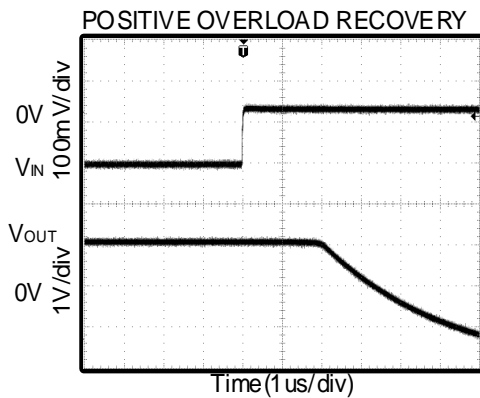
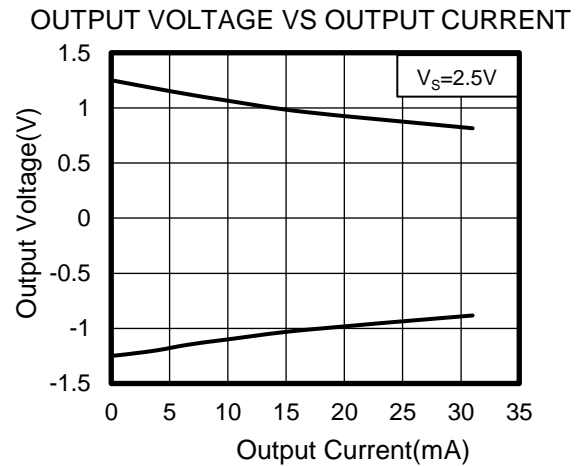
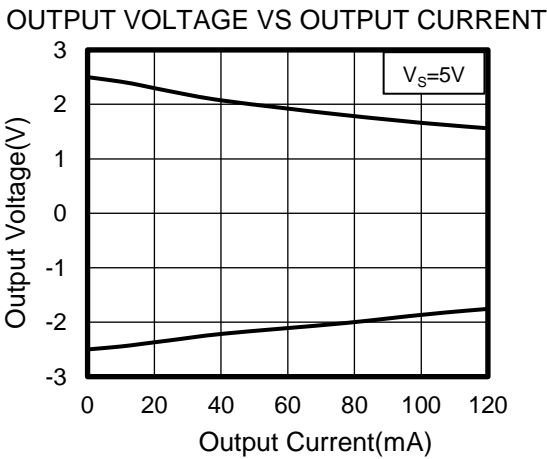
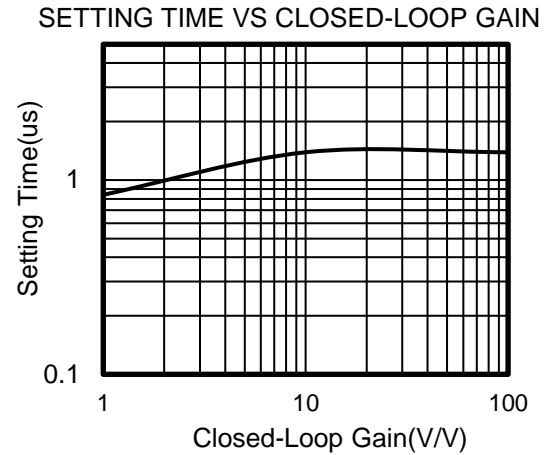
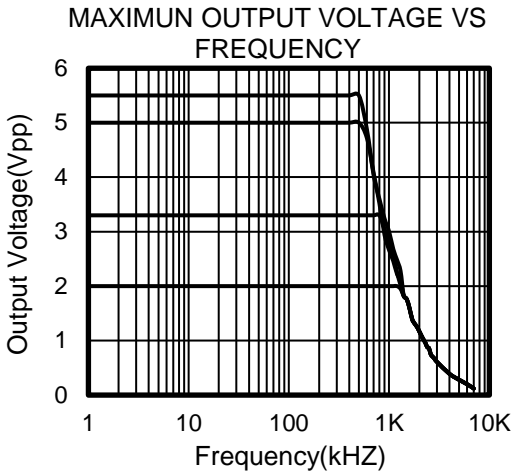

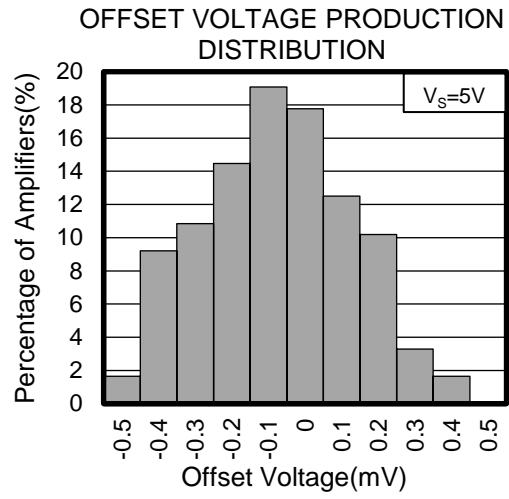

Detailed Description

Overview

The RS62XP devices are unity-gain stable, dual and quad-channel op amps with low noise and distortion. The device consists of a low noise input stage with a folded cascade and a rail-to-rail output stage. This topology exhibits superior noise and distortion performance across a wide range of supply voltages that are not delivered by legacy commodity audio operational amplifiers.

Phase Reversal Protection

The RS62XP family has internal phase-reversal protection. Many op amps exhibit phase reversal when the input is driven beyond the linear common-mode range. This condition is most often encountered in noninverting circuits when the input is driven beyond the specified common-mode voltage range, causing the output to reverse into the opposite rail. The input of the RS62XP prevents phase reversal with excessive common-mode voltage. Instead, the appropriate rail limits the output voltage. This performance is shown in figure 1.

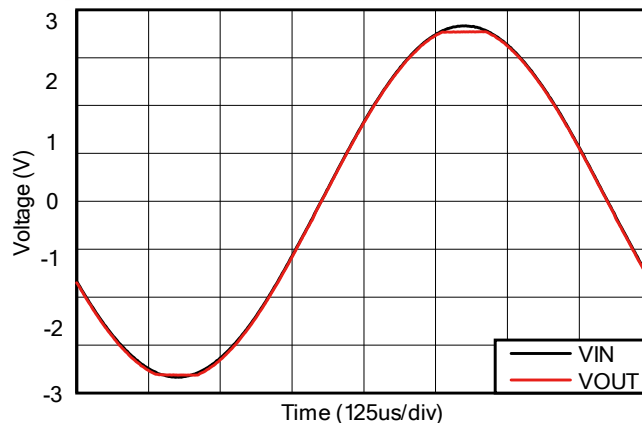

Figure 1. Output Waveform Devoid of Phase Reversal During an Input Overdrive Condition

EMI Rejection Ratio (EMIRR)

The electromagnetic interference (EMI) rejection ratio, or EMIRR, describes the EMI immunity of operational amplifiers. An adverse effect that is common to many operational amplifiers is a change in the offset voltage as a result of RF signal rectification. An operational amplifier that is more efficient at rejecting this change in offset as a result of EMI has a higher EMIRR and is quantified by a decibel value. Measuring EMIRR can be performed in many ways, but this document provides the EMIRR IN+, which specifically describes the EMIRR performance when the RF signal is applied to the noninverting input pin of the operational amplifier. In general, only the noninverting input is tested for EMIRR for the following three reasons:

- Operational amplifier input pins are known to be the most sensitive to EMI, and typically rectify RF signals better than the supply or output pins.
- The noninverting and inverting operational amplifier inputs have symmetrical physical layouts and exhibit nearly matching EMIRR performance.
- EMIRR is easier to measure on noninverting pins than on other pins because the noninverting input pin can be isolated on a printed-circuit-board (PCB). This isolation allows the RF signal to be applied directly to the noninverting input pin with no complex interactions from other components or connecting PCB traces.

Detailed Description (continued)

The EMIRR IN+ of the RS62XP is plotted versus frequency in Figure 2. If available, any dual and quad operational amplifier device versions have approximately identical EMIRR IN+ performance. The RS62XP unity-gain bandwidth is 7MHz. EMIRR performance below this frequency denotes interfering signals that fall within the operational amplifier bandwidth.

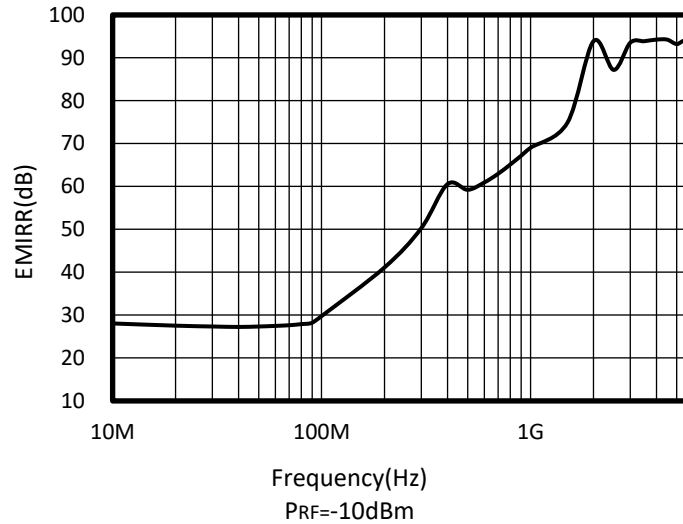

Figure 2. RS62XP EMIRR vs Frequency

EMIRR IN+ Test Configuration

Figure 3 shows the circuit configuration for testing the EMIRR IN+. An RF source is connected to the operational amplifier noninverting input pin using a transmission line. The operational amplifier is configured in a unity-gain buffer topology with the output connected to a low-pass filter (LPF) and a digital multimeter (DMM). A large impedance mismatch at the operational amplifier input causes a voltage reflection; however, this effect is characterized and accounted for when determining the EMIRR IN+. The resulting dc offset voltage is sampled and measured by the multimeter. The LPF isolates the multimeter from residual RF signals that can interfere with multimeter accuracy.

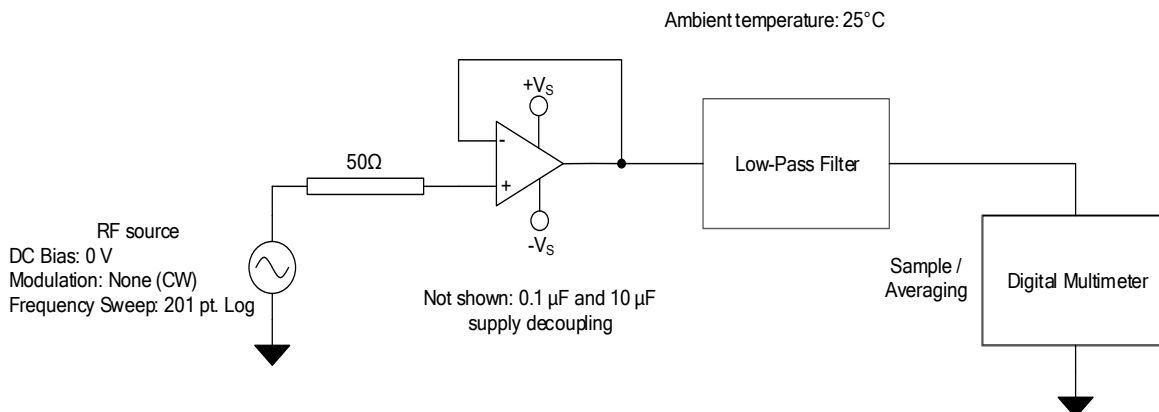

Figure 3. EMIRR IN+ Test Configuration Schematic

APPLICATION NOTE

The RS62XP series features 7MHz bandwidth and 3.7V/ μ s slew rate with only 720 μ A of supply current per channel, providing good AC performance at low power consumption. DC applications are well served with a low input noise voltage, low input bias current, and a typical input offset voltage of 0.3mV.

Typical Applications 25-kHz Low-pass Filter

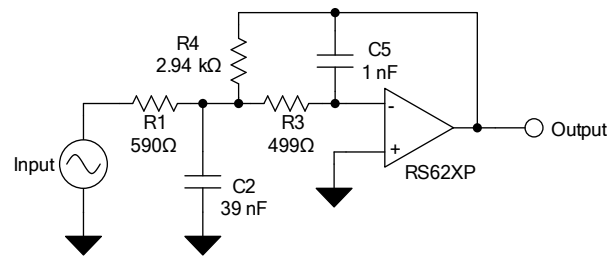

Figure 4. 25-kHz Low-Pass Filter

Design Requirements

Low-pass filters are commonly employed in signal processing applications to reduce noise and prevent aliasing. The RS62XP devices are ideally suited to construct high-speed, high-precision active filters. Figure 4 shows a second-order, low-pass filter commonly encountered in signal processing applications.

Use the following parameters for this design example:

- Gain = 5 V/V (inverting gain)
- Low-pass cutoff frequency = 25 kHz
- Second-order Chebyshev filter response with 3-dB gain peaking in the passband

Detailed Design Procedure

The infinite-gain multiple-feedback circuit for a low-pass network function is shown in Figure 4. Use Equation 1 to calculate the voltage transfer function.

$$\frac{\text{Output}}{\text{Input}}(s) = \frac{-1/R_1 R_3 C_2 C_5}{s^2 + (s/C_2) (1/R_1 + 1/R_3 + 1/R_4) + 1/R_3 R_4 C_2 C_5} \quad (1)$$

This circuit produces a signal inversion. For this circuit, the gain at dc and the low-pass cutoff frequency are calculated by Equation 2:

$$\text{Gain} = \frac{R_4}{R_1}$$

$$f_c = \frac{1}{2\pi} \sqrt{(1/R_3 R_4 C_2 C_5)}$$

(2)

Application Curve

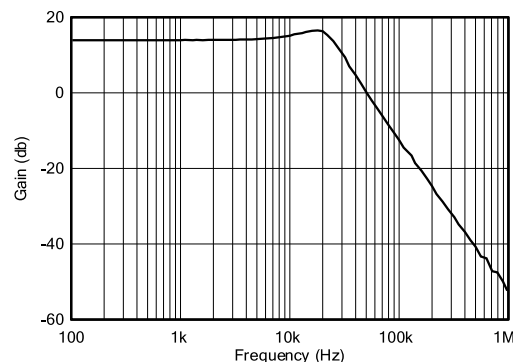

Figure 5. Low-pass filter transfer function

LAYOUT

Layout Guideline

Attention to good layout practices is always recommended. Keep traces short. When possible, use a PCB ground plane with surface-mount components placed as close to the device pins as possible. Place a 0.1uF capacitor closely across the supply pins.

These guidelines should be applied throughout the analog circuit to improve performance and provide benefits such as reducing the EMI susceptibility.

Layout Example

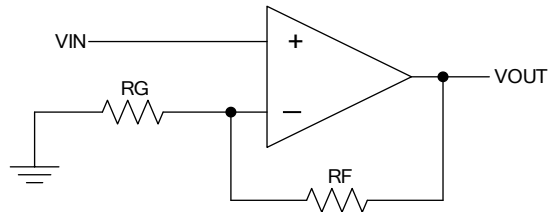

Figure 6. Schematic Representation

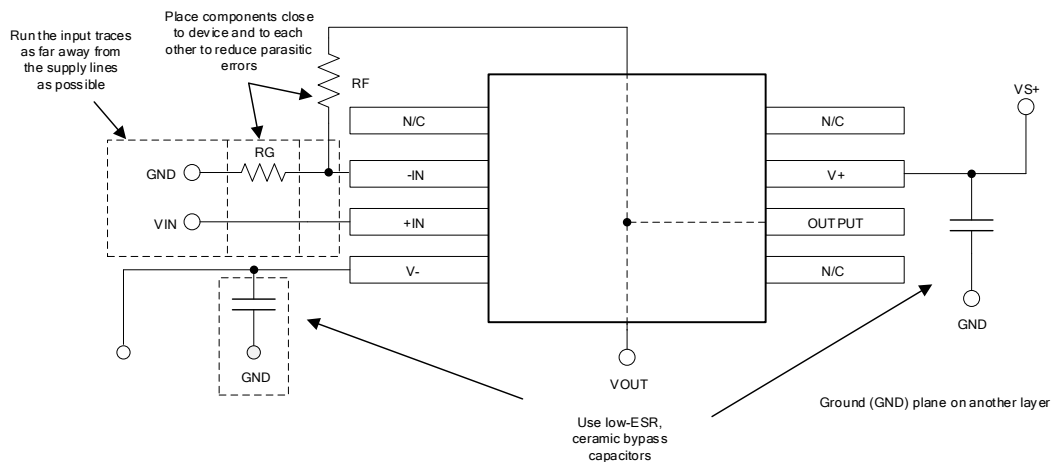
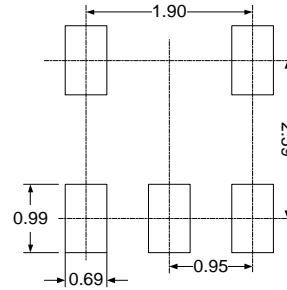
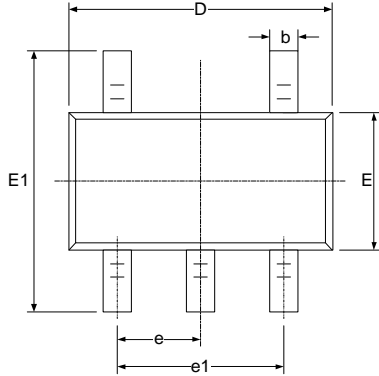
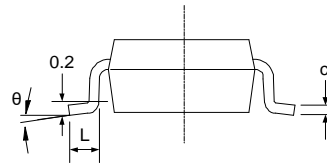
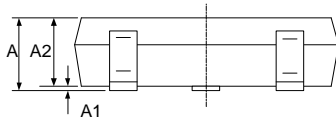
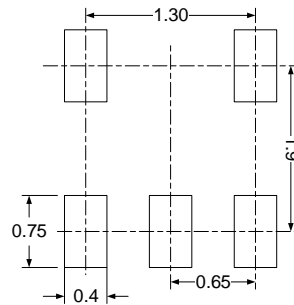
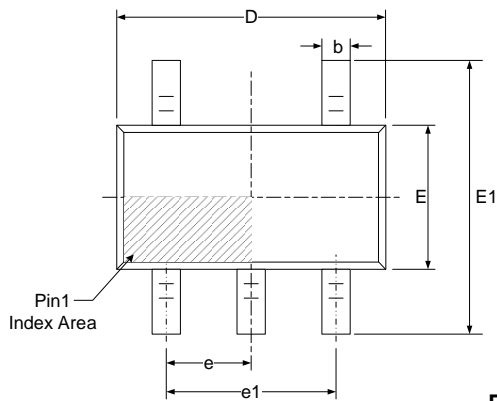
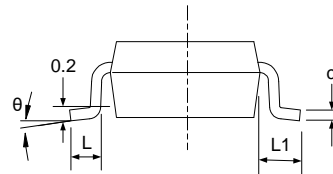
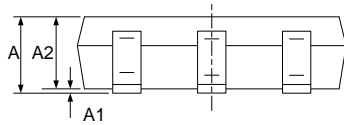

Figure 7. Operational Amplifier Board Layout for Noninverting Configuration

PACKAGE OUTLINE DIMENSIONS
SOT23-5

RECOMMENDED LAND PATTERN (Unit: mm)

Symbol	Dimensions In Millimeters		Dimensions In Inches	
	Min	Max	Min	Max
A	1.050	1.250	0.041	0.049
A1	0.000	0.100	0.000	0.004
A2	1.050	1.150	0.041	0.045
b	0.300	0.500	0.012	0.020
c	0.100	0.200	0.004	0.008
D	2.820	3.020	0.111	0.119
E	1.500	1.700	0.059	0.067
E1	2.650	2.950	0.104	0.116
e	0.950(BSC)		0.037(BSC)	
e1	1.800	2.000	0.071	0.079
L	0.300	0.600	0.012	0.024
θ	0°	8°	0°	8°

SOT353(SC70-5)

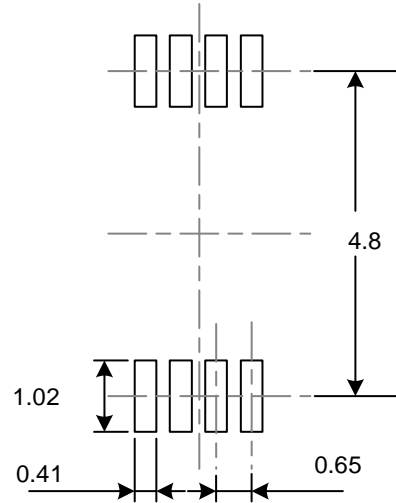
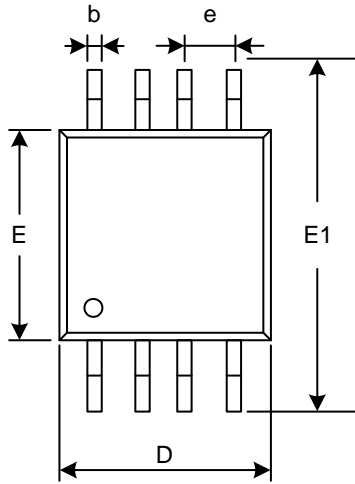
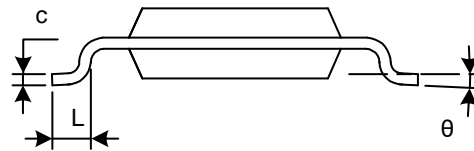
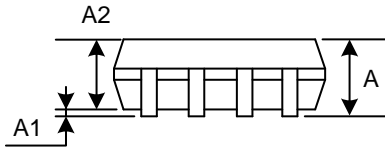
RECOMMENDED LAND PATTERN (Unit: mm)

Symbol	Dimensions In Millimeters		Dimensions In Inches	
	Min	Max	Min	Max
A	0.900	1.100	0.035	0.043
A1	0.000	0.100	0.000	0.004
A2	0.900	1.000	0.035	0.039
b	0.150	0.350	0.006	0.014
c	0.080	0.150	0.003	0.006
D	2.000	2.200	0.079	0.087
E	1.150	1.350	0.045	0.053
E1	2.150	2.450	0.085	0.096
e	0.650(BSC)		0.026(BSC)	
e1	1.300(BSC)		0.051(BSC)	
L	0.260	0.460	0.010	0.018
L1	0.525		0.021	
θ	0°	8°	0°	8°

MSOP-8

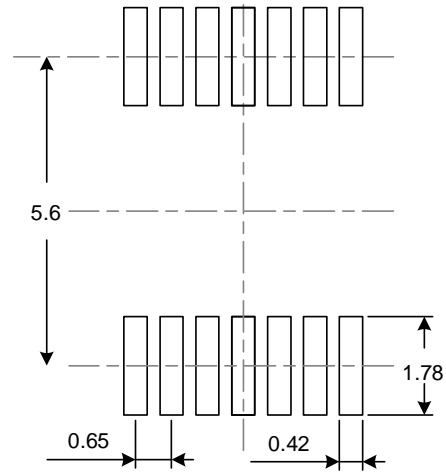
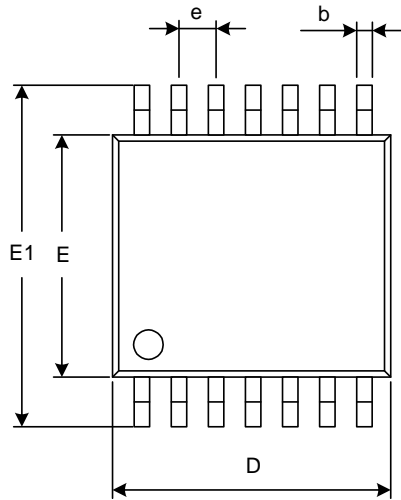
RECOMMENDED LAND PATTERN (Unit: mm)

Symbol	Dimensions In Millimeters		Dimensions In Inches	
	Min	Max	Min	Max
A	0.820	1.100	0.032	0.043
A1	0.020	0.150	0.001	0.006
A2	0.750	0.950	0.030	0.037
b	0.250	0.380	0.010	0.015
c	0.090	0.230	0.004	0.009
D	2.900	3.100	0.114	0.122
e	0.650(BSC)		0.026(BSC)	
E	2.900	3.100	0.114	0.122
E1	4.750	5.050	0.187	0.199
L	0.400	0.800	0.016	0.031
θ	0°	6°	0°	6°

TSSOP-14

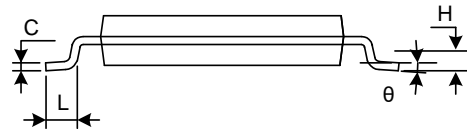
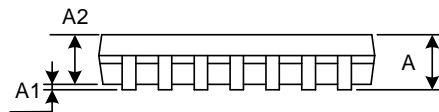
RECOMMENDED LAND PATTERN (Unit: mm)

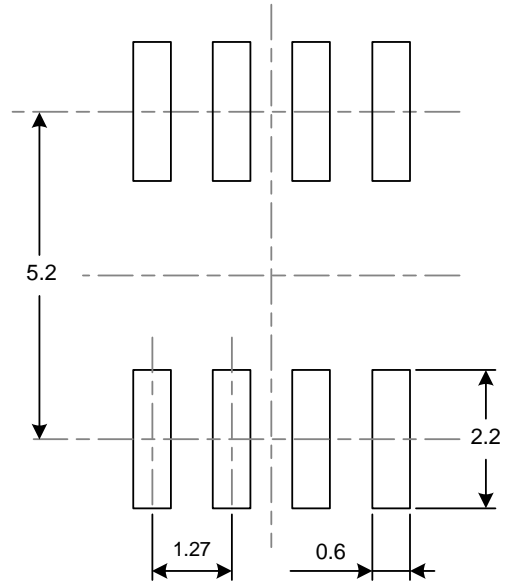
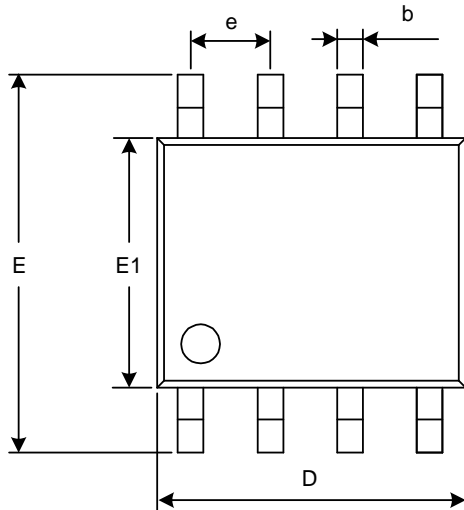

Symbol	Dimensions In Millimeters		Dimensions In Inches	
	Min	Max	Min	Max
A		1.200		0.047
A1	0.050	0.150	0.002	0.006
A2	0.800	1.050	0.031	0.041
b	0.190	0.300	0.007	0.012
c	0.090	0.200	0.004	0.008
D	4.860	5.100	0.191	0.201
E	4.300	4.500	0.169	0.177
E1	6.250	6.550	0.246	0.258
e	0.650(BSC)		0.026(BSC)	
L	0.500	0.700	0.020	0.028
H	0.25(TYP)		0.01(TYP)	
θ	1°	7°	1°	7°

SOIC-8(SOP8)

RECOMMENDED LAND PATTERN (Unit: mm)

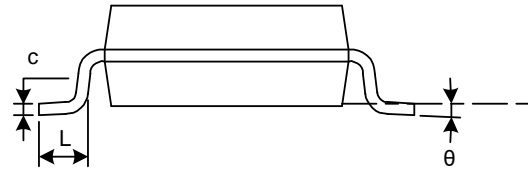
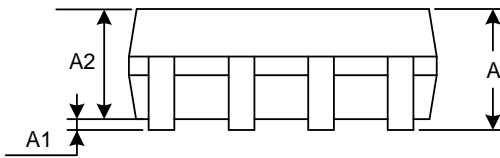

Symbol	Dimensions In Millimeters		Dimensions In Inches	
	Min	Max	Min	Max
A	1.350	1.750	0.053	0.069
A1	0.100	0.250	0.004	0.010
A2	1.350	1.550	0.053	0.061
b	0.330	0.510	0.013	0.020
c	0.170	0.250	0.007	0.010
D	4.800	5.000	0.189	0.197
e	1.270(BSC)		0.050(BSC)	
E	5.800	6.200	0.228	0.244
E1	3.800	4.000	0.150	0.157
L	0.400	1.270	0.016	0.050
θ	0°	8°	0°	8°

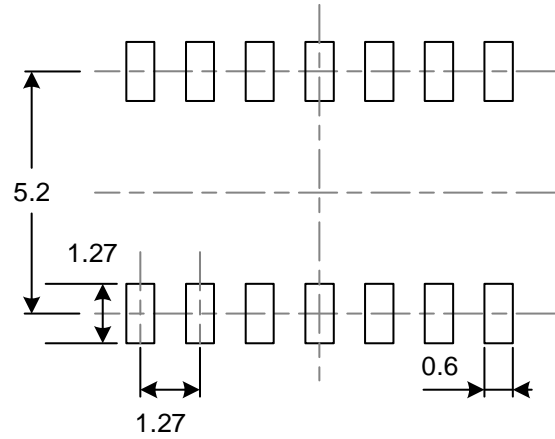
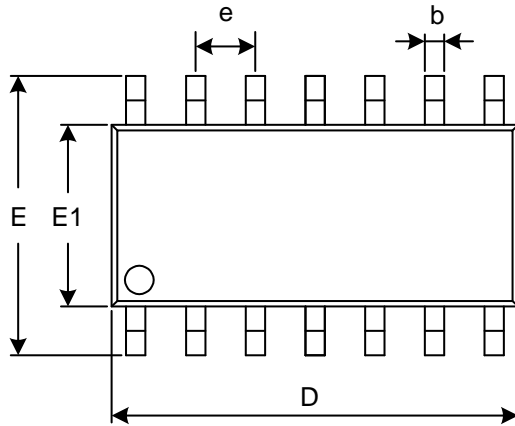
SOIC-14(SOP14)

RECOMMENDED LAND PATTERN (Unit: mm)

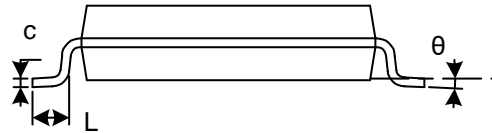
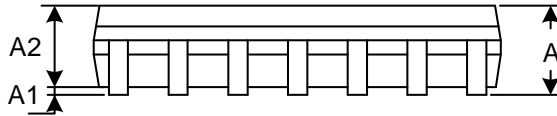

Symbol	Dimensions In Millimeters		Dimensions In Inches	
	Min	Max	Min	Max
A	1.350	1.750	0.053	0.069
A1	0.100	0.250	0.004	0.010
A2	1.350	1.550	0.053	0.061
b	0.310	0.510	0.012	0.020
c	0.100	0.250	0.004	0.010
D	8.450	8.850	0.333	0.348
e	1.270(BSC)		0.050(BSC)	
E	5.800	6.200	0.228	0.244
E1	3.800	4.000	0.150	0.157
L	0.400	1.270	0.016	0.050
θ	0°	8°	0°	8°

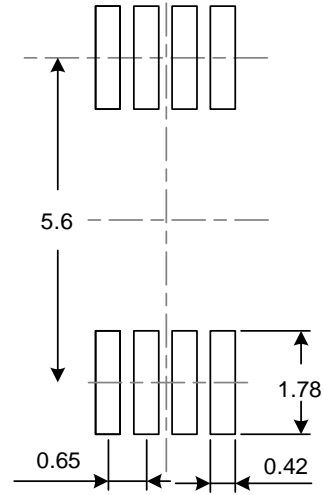
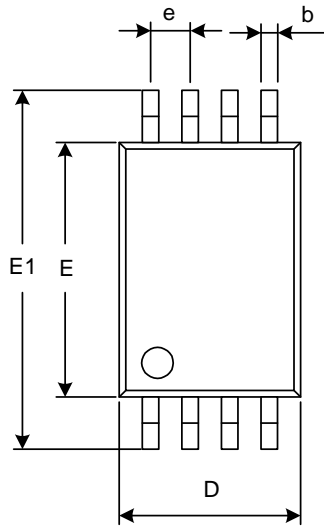
TSSOP-8

RECOMMENDED LAND PATTERN (Unit: mm)

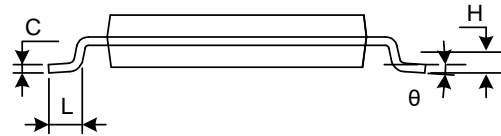
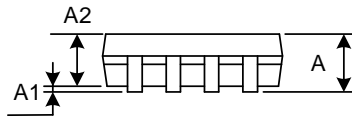

Symbol	Dimensions In Millimeters		Dimensions In Inches	
	Min	Max	Min	Max
A		1.200		0.047
A1	0.050	0.150	0.002	0.006
A2	0.800	1.050	0.031	0.041
b	0.190	0.300	0.007	0.012
c	0.090	0.200	0.004	0.008
D	2.900	3.100	0.114	0.122
E	4.300	4.500	0.169	0.177
E1	6.250	6.550	0.246	0.258
e	0.650(BSC)		0.026(BSC)	
L	0.500	0.700	0.020	0.028
H	0.25(TYP)		0.01(TYP)	
θ	1°	7°	1°	7°

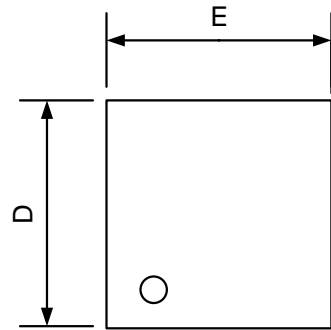
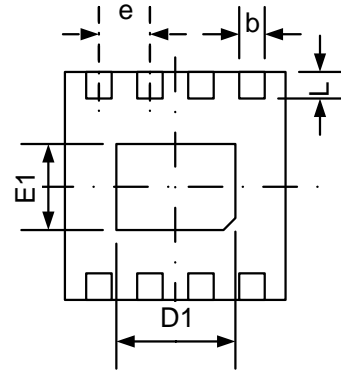
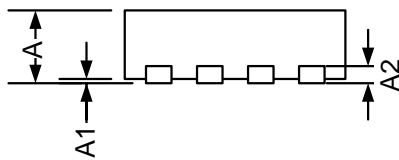
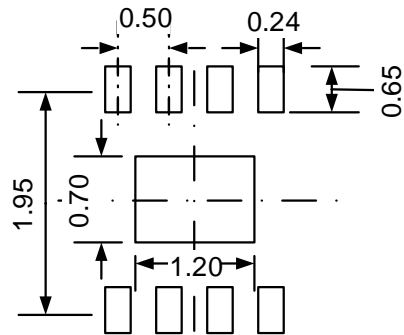
TDFN2x2-8L

TOP VIEW

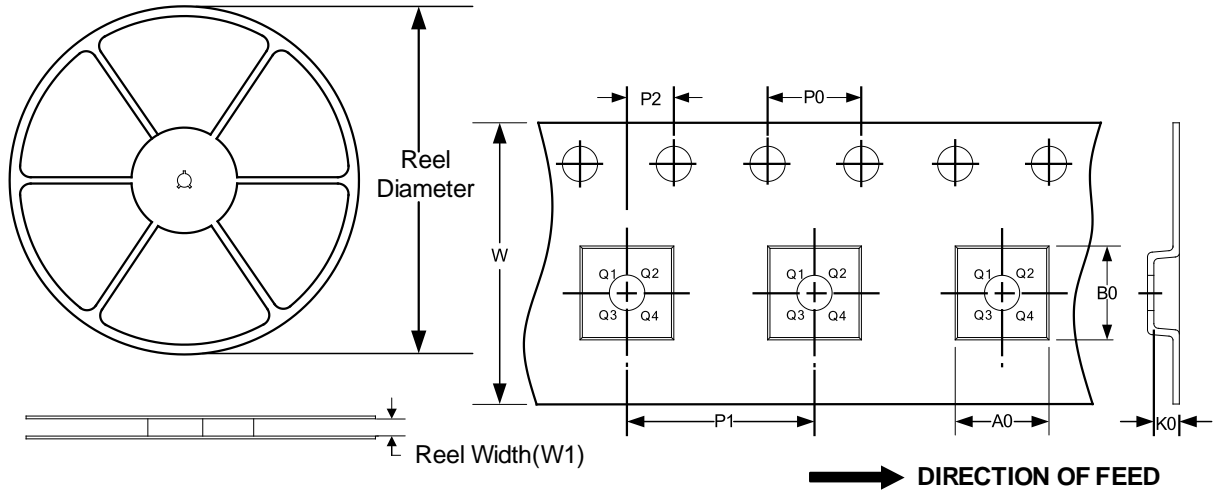
BOTTOM VIEW

SIDE VIEW

RECOMMENDED LAND PATTERN (Unit: mm)

Symbol	Dimensions In Millimeters		Dimensions In Inches	
	Min	Max	Min	Max
A	0.700	0.800	0.028	0.031
A1	0.000	0.050	0.000	0.002
A2	0.203(TYP)		0.008(TYP)	
b	0.180	0.300	0.007	0.012
D	1.900	2.100	0.075	0.083
D1	1.100	1.300	0.043	0.051
E	1.900	2.100	0.075	0.083
E1	0.600	0.800	0.024	0.031
e	0.500(TYP)		0.020(TYP)	
L	0.250	0.450	0.010	0.018

TAPE AND REEL INFORMATION
REEL DIMENSIONS
TAPE DIMENSION

NOTE: The picture is only for reference. Please make the object as the standard.

KEY PARAMETER LIST OF TAPE AND REEL

Package Type	Reel Diameter	Reel Width(mm)	A0 (mm)	B0 (mm)	K0 (mm)	P0 (mm)	P1 (mm)	P2 (mm)	W (mm)	Pin1 Quadrant
SOT23-5	7"	9.5	3.20	3.20	1.40	4.0	4.0	2.0	8.0	Q3
SOIC-8(SOP8)	13"	12.4	6.40	5.40	2.10	4.0	8.0	2.0	12.0	Q1
MSOP-8	13"	12.4	5.20	3.30	1.50	4.0	8.0	2.0	12.0	Q1
SOIC-14(SOP14)	13"	16.4	6.60	9.30	2.10	4.0	8.0	2.0	16.0	Q1
TSSOP-14	13"	12.4	6.95	5.60	1.20	4.0	8.0	2.0	12.0	Q1
SOT353(SC70-5)	7"	9.5	2.25	2.55	1.20	4.0	4.0	2.0	8.0	Q3
TDFN2X2-8L	7"	9.5	2.30	2.30	1.10	4.0	4.0	2.0	8.0	Q2