

# RS1G86 Single 2-Input Exclusive-OR Gate

## FEATURES

- Operating Voltage Range: 1.65V to 5.5V
- Low Power Consumption: 1µA (Max)
- Operating Temperature Range: -40°C to +125°C
- Inputs Accept Voltage to 5.5V
- High Output Drive: ±24mA at V<sub>CC</sub>=3.0V
- **Micro SIZE PACKAGES: SOT23-5, SC70-5**

## APPLICATIONS

- AV Receiver
- Blu-ray Player and Home Theater
- Digital Picture Frame (DPF)
- High-Speed Data Acquisition and Generation
- Personal Navigation Device (GPS)
- Portable Media Player

### LOGIC SYMBOL



### IEE/IEC LOGIC SYMBOL

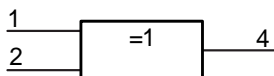

## DESCRIPTION

The RS1G86 single 2-input exclusive-OR gate is designed for 1.65V to 5.5V V<sub>CC</sub> operation.

The RS1G86 device performs the Boolean function  $Y = \bar{A}B + A\bar{B}$  in positive logic. The device is fully specified for partial-power-down applications using I<sub>off</sub>. The I<sub>off</sub> circuitry disables the outputs, preventing damaging current backflow through the device when it is powered down.

The RS1G86 is available in Green SOT23-5 and SC70-5 packages. It operates over an ambient temperature range of -40°C to +125°C.

### Device Information (1)

PART NUMBER	PACKAGE	BODY SIZE (NOM)
RS1G86	SOT23-5(5)	2.92mm×1.60mm
	SC70-5(5)	2.10mm×1.25mm

(1) For all available packages, see the orderable addendum at the end of the data sheet.

### FUNCTION TABLE

INPUTS		OUTPUT
A	B	Y
H	H	L
L	H	H
H	L	H
L	L	L

H=High Voltage Level

L=Low Voltage Level

## Revision History

Note: Page numbers for previous revisions may differ from page numbers in the current version.

Version	Change Date	Change Item
A.1	2021/01/21	Initial version completed
A.2	2022/04/27	1. Added the TAPE AND REEL INFORMATION 2. Update PACKAGE MARKING on Page 5@RevA.1

## PIN CONFIGURATIONS

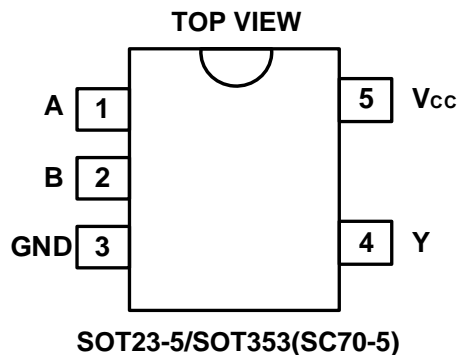

## PIN DESCRIPTION

PIN	NAME	I/O TYPE	FUNCTION
<b>SOT23-5/SOT353(SC70-5)</b>			
1	A	I	Input A
2	B	I	Input B
3	GND	P	Ground
4	Y	O	Output Y
5	V <sub>CC</sub>	P	Power pin

## Specifications

### Absolute Maximum Ratings <sup>(1)</sup>

over operating free-air temperature range (unless otherwise noted) <sup>(1)</sup> <sup>(2)</sup>

		MIN	MAX	UNIT
V <sub>CC</sub>	Supply voltage range	-0.5	6.5	V
V <sub>I</sub>	Input voltage range <sup>(2)</sup>	-0.5	6.5	V
V <sub>O</sub>	Voltage range applied to any output in the high-impedance or power-off state <sup>(2)</sup>	-0.5	6.5	V
V <sub>O</sub>	Voltage range applied to any output in the high or low state <sup>(2)</sup> <sup>(3)</sup>	-0.5	V <sub>CC</sub> +0.5	V
I <sub>IK</sub>	Input clamp current	V <sub>I</sub> <0	-50	mA
I <sub>OK</sub>	Output clamp current	V <sub>O</sub> <0	-50	mA
I <sub>O</sub>	Continuous output current		±50	mA
	Continuous current through V <sub>CC</sub> or GND		±100	mA
T <sub>J</sub>	Junction temperature	-65	150	°C
T <sub>stg</sub>	Storage temperature	-65	150	°C

(1) Stresses beyond those listed under *Absolute Maximum Ratings* may cause permanent damage to the device. These are stress ratings only, and functional operation of the device at these or any other conditions beyond those indicated under *Recommended Operating Conditions* is not implied. Exposure to absolute-maximum-rated conditions for extended periods may affect device reliability.

(2) The input and output negative-voltage ratings may be exceeded if the input and output current ratings are observed.

(3) The value of V<sub>CC</sub> is provided in the *Recommended Operating Conditions table*.

### ESD Ratings

		VALUE	UNIT	
V <sub>(ESD)</sub>	Electrostatic discharge	Human-body model (HBM)	±8000	V
		Machine model (MM)	±500	V

### Thermal Information:

THERMAL METRIC		RS1G86		UNIT
		5PINS		
		SOT23-5	SOT353/(SC70-5)	
R <sub>θJA</sub>	Junction-to-ambient thermal resistance	273.8	214.7	°C/W
R <sub>θJC(top)</sub>	Junction-to-case(top) thermal resistance	126.8	127.1	°C/W
R <sub>θJB</sub>	Junction-to-board thermal resistance	85.9	60.0	°C/W
Ψ <sub>JT</sub>	Junction-to-top characterization parameter	10.9	33.4	°C/W
Ψ <sub>JB</sub>	Junction-to-board characterization parameter	84.9	59.8	°C/W
R <sub>θJC(bot)</sub>	Junction-to-case(bottom) thermal resistance	N/A	N/A	°C/W

**PACKAGE/ORDERING INFORMATION**

PRODUCT	ORDERING NUMBER	TEMPERATURE RANGE	PACKAGE LEAD	PACKAGE MARKING <sup>(1)</sup>	PACKAGE OPTION
RS1G86	RS1G86XF5	-40°C ~+125°C	SOT23-5	1G86	Tape and Reel,3000
	RS1G86XC5	-40°C ~+125°C	SC70-5(SOT353)	1G86	Tape and Reel,3000

## NOTE:

- (1) There may be additional marking, which relates to the lot trace code information (data code and vendor code), the logo or the environmental category on the device.

## ELECTRICAL CHARACTERISTICS

over recommended operating free-air temperature range (TYP values are at  $T_A = +25^{\circ}\text{C}$ , unless otherwise noted.) <sup>(1)</sup>

### Recommended Operating Conditions

PARAMETER	SYMBOL	TEST CONDITIONS	MIN	MAX	UNIT
Supply voltage	$V_{CC}$	Operating	1.65	5.5	V
		Data retention only	1.5		
High-level input voltage	$V_{IH}$	$V_{CC}=1.65\text{V to }1.95\text{V}$	$0.65 \times V_{CC}$		V
		$V_{CC}=2.3\text{V to }2.7\text{V}$	1.7		
		$V_{CC}=3\text{V to }3.6\text{V}$	2.2		
		$V_{CC}=4.5\text{V to }5.5\text{V}$	$0.7 \times V_{CC}$		
Low-level input voltage	$V_{IL}$	$V_{CC}=1.65\text{V to }1.95\text{V}$		$0.20 \times V_{CC}$	V
		$V_{CC}=2.3\text{V to }2.7\text{V}$		0.3	
		$V_{CC}=3\text{V to }3.6\text{V}$		0.4	
		$V_{CC}=4.5\text{V to }5.5\text{V}$		$0.15 \times V_{CC}$	
Input voltage	$V_I$		0	5.5	V
Output voltage	$V_O$		0	$V_{CC}$	V
Input transition rise or fall	$t_r, t_f$	$V_{CC}=1.8\text{V} \pm 0.15\text{V}, 2.5\text{V} \pm 0.2\text{V}$		20	ns/V
		$V_{CC}=3.3\text{V} \pm 0.3\text{V}$		10	
		$V_{CC}=5\text{V} \pm 0.5\text{V}$		5	
Operating temperature	$T_A$		-40	+125	$^{\circ}\text{C}$

### DC Characteristics

PARAMETER	TEST CONDITIONS	$V_{CC}$	TEMP	MIN	TYP	MAX	UNIT
$V_{OH}$	$I_{OH} = -100\mu\text{A}$	1.65V to 5.5V	Full	$V_{CC}-0.1$			V
	$I_{OH} = -4\text{mA}$	1.65V		1.2			
	$I_{OH} = -8\text{mA}$	2.3V		1.9			
	$I_{OH} = -16\text{mA}$	3V		2.4			
	$I_{OH} = -24\text{mA}$			2.3			
	$I_{OH} = -32\text{mA}$	4.5V		3.8			
$V_{OL}$	$I_{OL} = 100\mu\text{A}$	1.65V to 5.5V	Full			0.1	V
	$I_{OL} = 4\text{mA}$	1.65V				0.45	
	$I_{OL} = 8\text{mA}$	2.3V				0.3	
	$I_{OL} = 16\text{mA}$	3V				0.4	
	$I_{OL} = 24\text{mA}$					0.55	
	$I_{OL} = 32\text{mA}$	4.5V				0.55	
$I_i$	A or B inputs	$V_I=5.5\text{V or GND}$	0V to 5.5V	+25 $^{\circ}\text{C}$	$\pm 0.1$	$\pm 1$	$\mu\text{A}$
				Full		$\pm 5$	
$I_{off}$		$V_I \text{ or } V_O=5.5\text{V}$	0V	+25 $^{\circ}\text{C}$	$\pm 0.1$	$\pm 1$	$\mu\text{A}$
				Full		$\pm 10$	
$I_{CC}$		$V_I=5.5\text{V or GND}, I_o=0$	1.65V to 5.5V	+25 $^{\circ}\text{C}$	0.1	1	$\mu\text{A}$
				Full		10	
$\Delta I_{CC}$		One input at $V_{CC}-0.6\text{V}$ , Other inputs at $V_{CC}$ or GND	3V to 5.5V	Full		500	$\mu\text{A}$

**AC Characteristics**

( $T_A = -40^{\circ}\text{C}$  to  $+25^{\circ}\text{C}$ , typical values are at  $T_A = +25^{\circ}\text{C}$ , unless otherwise noted.) <sup>(1)</sup>

PARAMETER	SYMBOL	TEST CONDITIONS		MIN	TYP	MAX	UNIT
Propagation Delay	$t_{pd}$	$V_{CC}=1.8V\pm 0.15V$	$C_L=30pF, R_L=1k\Omega$		14.2		ns
		$V_{CC}=2.5V\pm 0.2V$	$C_L=30pF, R_L=500\Omega$		11.1		
		$V_{CC}=3.3V\pm 0.3V$	$C_L=50pF, R_L=500\Omega$		6.7		
		$V_{CC}=5V\pm 0.5V$	$C_L=50pF, R_L=500\Omega$		5.3		
Input Capacitance	$C_i$	$V_{CC}=3.3V$	$V_I=V_{CC}$ or GND		4		pF
Power dissipation capacitance	$C_{pd}$	$V_{CC}=1.8V$	$f=10MHz$		20		pF
		$V_{CC}=2.5V$			21		
		$V_{CC}=3.3V$			22		
		$V_{CC}=5V$			25		

(1) All unused inputs of the device must be held at  $V_{CC}$  or GND to ensure proper device operation.

## Parameter Measurement Information

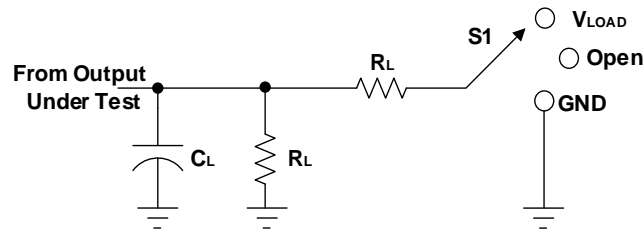

TEST	S1
$t_{PLH}/t_{PHL}$	Open
$t_{PLZ}/t_{PZL}$	$V_{LOAD}$
$t_{PHZ}/t_{PZH}$	GND

$V_{CC}$	INPUTS		$V_M$	$V_{LOAD}$	$C_L$	$R_L$	$V_{\Delta}$
	$V_I$	$t_r/t_f$					
$1.8V \pm 0.15V$	$V_{CC}$	$\leq 2ns$	$V_{CC}/2$	$2 \times V_{CC}$	15pF	1M $\Omega$	0.15V
$2.5V \pm 0.2V$	$V_{CC}$	$\leq 2ns$	$V_{CC}/2$	$2 \times V_{CC}$	15pF	1M $\Omega$	0.15V
$3.3V \pm 0.3V$	3V	$\leq 2.5ns$	1.5V	6V	15pF	1M $\Omega$	0.3V
$5V \pm 0.5V$	$V_{CC}$	$\leq 2.5ns$	$V_{CC}/2$	$2 \times V_{CC}$	15pF	1M $\Omega$	0.3V

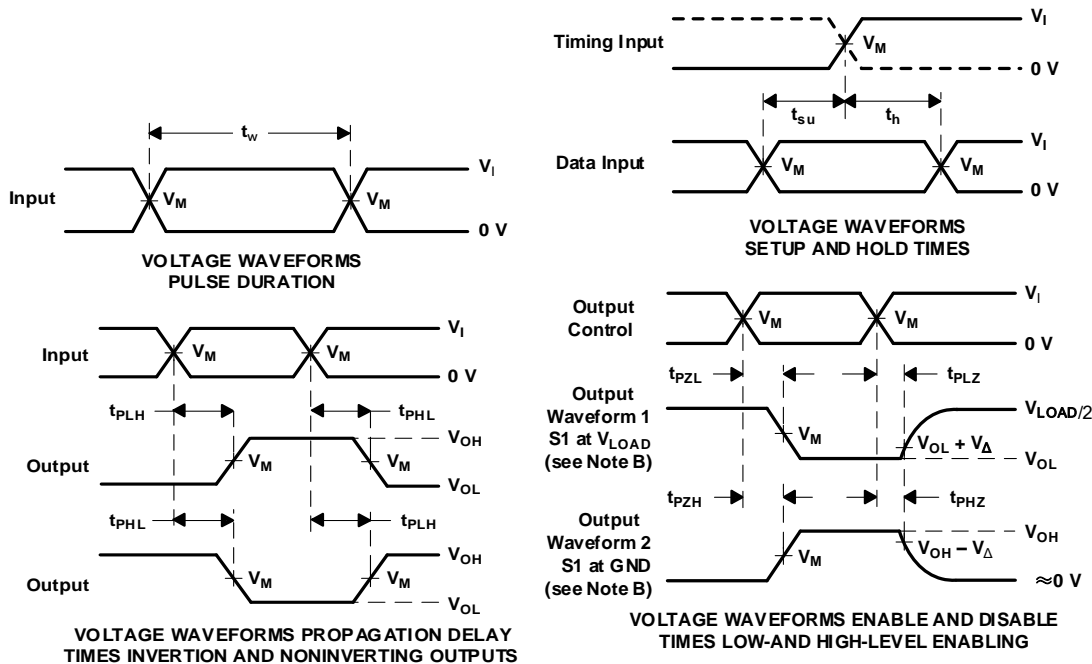

- NOTES:
- A.  $C_L$  includes probe and jig capacitance.
  - B. Waveform 1 is for an output with internal conditions such that the output is low, except when disabled by the output control. Waveform 2 is for an output with internal conditions such that the output is high, except when disabled by the output control.
  - C. All input pulses are supplied by generators having the following characteristics:  $PRR \leq 10 \text{ MHz}$ ,  $Z_0 = 50 \Omega$ .
  - D. The outputs are measured one at a time, with one transition per measurement.
  - E.  $t_{PLZ}$  and  $t_{PHZ}$  are the same as  $t_{dis}$ .
  - F.  $t_{PZL}$  and  $t_{PZH}$  are the same as  $t_{en}$ .
  - G.  $t_{PLH}$  and  $t_{PHL}$  are the same as  $t_{pd}$ .
  - H. All parameters and waveforms are not applicable to all devices.

**Figure 1. Load Circuit and Voltage Waveforms**



# PACKAGE OUTLINE DIMENSIONS

## SOT23-5

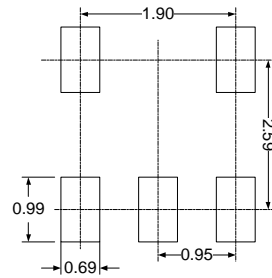
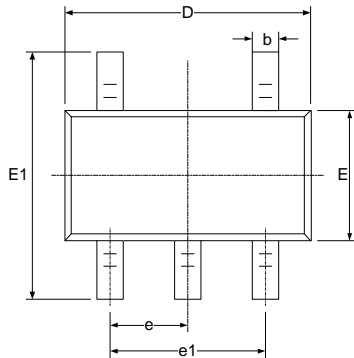
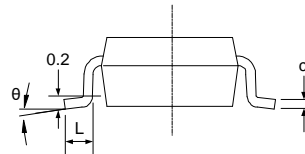
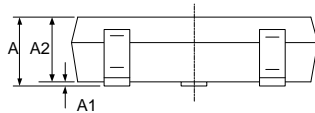
**RECOMMENDED LAND PATTERN (Unit: mm)**

Symbol	Dimensions In Millimeters		Dimensions In Inches	
	Min	Max	Min	Max
A	1.050	1.250	0.041	0.049
A1	0.000	0.100	0.000	0.004
A2	1.050	1.150	0.041	0.045
b	0.300	0.500	0.012	0.020
c	0.100	0.200	0.004	0.008
D	2.820	3.020	0.111	0.119
E	1.500	1.700	0.059	0.067
E1	2.650	2.950	0.104	0.116
e	0.950(BSC)		0.037(BSC)	
e1	1.800	2.000	0.071	0.079
L	0.300	0.600	0.012	0.024
$\theta$	0°	8°	0°	8°

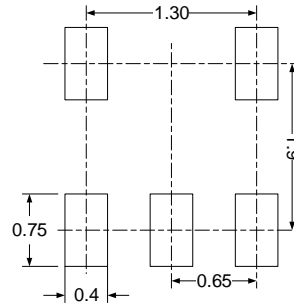
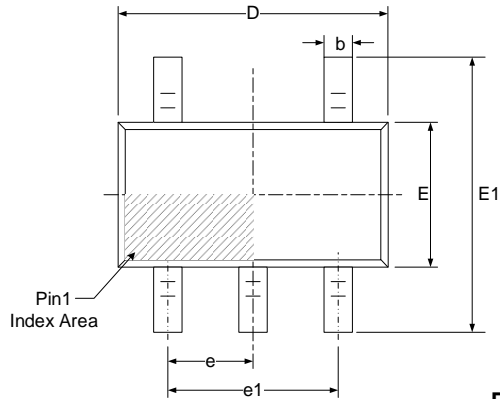
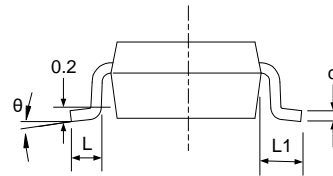
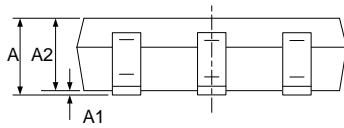
**SOT353(SC70-5)**

**RECOMMENDED LAND PATTERN (Unit: mm)**

Symbol	Dimensions In Millimeters		Dimensions In Inches	
	Min	Max	Min	Max
A	0.900	1.100	0.035	0.043
A1	0.000	0.100	0.000	0.004
A2	0.900	1.000	0.035	0.039
b	0.150	0.350	0.006	0.014
c	0.080	0.150	0.003	0.006
D	2.000	2.200	0.079	0.087
E	1.150	1.350	0.045	0.053
E1	2.150	2.450	0.085	0.096
e	0.650(BSC)		0.026(BSC)	
e1	1.300(BSC)		0.051(BSC)	
L	0.260	0.460	0.010	0.018
L1	0.525		0.021	
θ	0°	8°	0°	8°

## TAPE AND REEL INFORMATION

### REEL DIMENSIONS

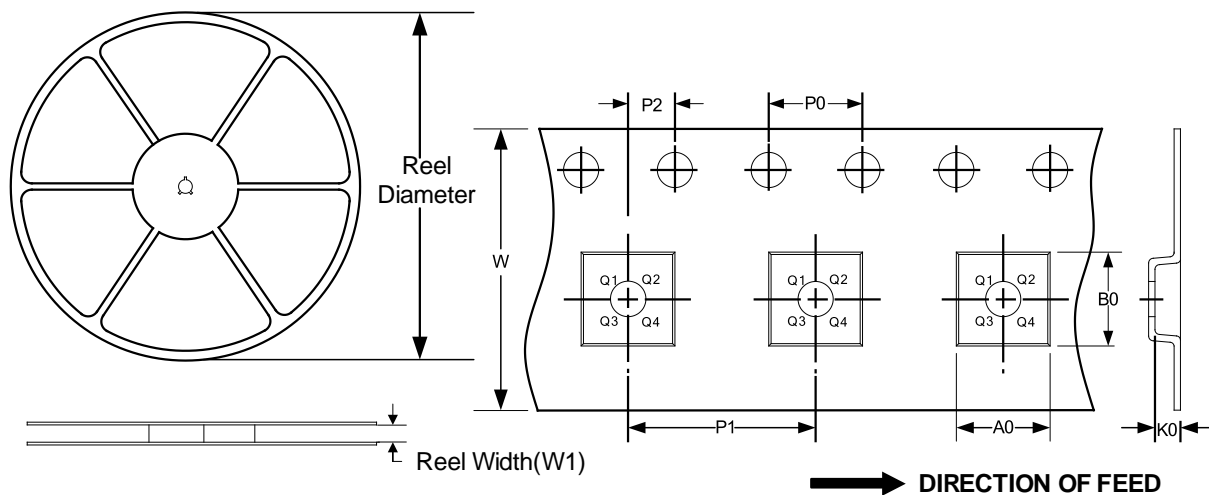
### TAPE DIMENSION



NOTE: The picture is only for reference. Please make the object as the standard.

### KEY PARAMETER LIST OF TAPE AND REEL

Package Type	Reel Diameter	Reel Width(mm)	A0 (mm)	B0 (mm)	K0 (mm)	P0 (mm)	P1 (mm)	P2 (mm)	W (mm)	Pin1 Quadrant
SOT23-5	7"	9.5	3.20	3.20	1.40	4.0	4.0	2.0	8.0	Q3
SOT353(SC70-5)	7"	9.5	2.25	2.55	1.20	4.0	4.0	2.0	8.0	Q3