

# 150kHz, Rail-to-Rail I/O CMOS Operational Amplifier

## 1 FEATURES

- **GAIN BANDWIDTH: 150kHz**
- **RAIL-TO-RAIL INPUT AND OUTPUT**  
**±0.8mV Typical Vos**
- **INPUT VOLTAGE RANGE: -0.1V to +5.6V**  
**with  $V_s = 5.5V$**
- **SUPPLY RANGE: +2.5V to +5.5V**
- **SHUTDOWN: RS121S/RS122S**
- **SPECIFIED UP TO +125°C**
- **Micro SIZE PACKAGES: SOT23-5, SOT23-6**

## 2 APPLICATIONS

- **SENSORS**
- **PHOTODIODE AMPLIFICATION**
- **ACTIVE FILTERS**
- **TEST EQUIPMENT**
- **DRIVING A/D CONVERTERS**

## 3 DESCRIPTIONS

The RS121, RS122, RS124, RS121S, RS122S families of products offer low voltage operation and rail-to-rail input and output, as well as excellent speed/power consumption ratio, providing an excellent bandwidth (150kHz) and slew rate of 0.05V/us. The op-amps are unity gain stable and feature an ultra-low input bias current.

The devices are ideal for sensor interfaces, active filters and portable applications. The RS121S, RS122S include a shutdown mode. Under logic control, the amplifiers can be switched from normal operation to a standby current that is less than 1uA. The RS121, RS122, RS124, RS121S, RS122S families of operational amplifiers are specified at the full temperature range of -40°C to +125°C under single or dual power supplies of 2.5V to 5.5V.

**Device Information <sup>(1)</sup>**

PART NUMBER	PACKAGE	BODY SIZE(NOM)
RS121	SOT23-5	2.90mm×1.60mm
	SOIC-8(SOP8)	4.90mm×3.90mm
	MSOP-8	3.00mm×3.00mm
RS121S	SOT23-6	2.90mm×1.60mm
	SOIC-8(SOP8)	4.90mm×3.90mm
RS122	SOIC-8(SOP8)	4.90mm×3.90mm
	MSOP-8	3.00mm×3.00mm
	DFN3×3-8L	3.00mm×3.00mm
RS122S	MSOP-10	3.00mm×3.00mm
RS124	SOIC-14(SOP14)	8.65mm×3.90mm
	TSSOP-14	5.00mm×4.40mm

(1) For all available packages, see the orderable addendum at the end of the data sheet.

## Table of Contents

<b>1 FEATURES</b> .....	1
<b>2 APPLICATIONS</b> .....	1
<b>3 DESCRIPTIONS</b> .....	1
<b>4 Revision History</b> .....	3
<b>5 PACKAGE/ORDERING INFORMATION</b> <sup>(1)</sup> .....	4
<b>6 Pin Configuration and Functions (Top View)</b> .....	5
<b>7 SPECIFICATIONS</b> .....	8
7.1 Absolute Maximum Ratings .....	8
7.2 ESD Ratings .....	8
7.3 Recommended Operating Conditions .....	9
7.4 ELECTRICAL CHARACTERISTICS .....	10
7.5 TYPICAL CHARACTERISTICS .....	11
<b>8 Application and Implementation</b> .....	13
8.1 APPLICATION NOTE .....	13
8.2 RS121S/RS122S ENABLE FUNCTION .....	13
8.3 LAYOUT GUIDELINS .....	13
8.4 INSTRUMENTATION AMPLIFIER .....	13
<b>9 PACKAGE OUTLINE DIMENSIONS</b> .....	14
<b>10 TAPE AND REEL INFORMATION</b> .....	22

## 4 Revision History

Note: Page numbers for previous revisions may differ from page numbers in the current version.

Version	Change Date	Change Item
C.1	2022/12/30	1. Update Package Qty on Page 2@RevB.2 2. Added TAPE AND REEL INFORMATION 3. Update ELECTRICAL CHARACTERISTICS on Page 3@RevB.2

**5 PACKAGE/ORDERING INFORMATION <sup>(1)</sup>**

Orderable Device	Package Type	Pin	Channel	Op Temp(°C)	Device Marking <sup>(2)</sup>	Package Qty
RS121XF	SOT23-5	5	1	-40°C ~125°C	121	Tape and Reel,3000
RS121BXF	SOT23-5	5	1	-40°C ~125°C	121B	Tape and Reel,3000
RS121XK	SOIC-8(SOP8)	8	1	-40°C ~125°C	RS121	Tape and Reel,4000
RS121XM	MSOP-8	8	1	-40°C ~125°C	RS121	Tape and Reel,4000
RS121SXK	SOIC-8(SOP8)	8	1	-40°C ~125°C	RS121S	Tape and Reel,4000
RS121SXH	SOT23-6	6	1	-40°C ~125°C	121S	Tape and Reel,3000
RS122XK	SOIC-8(SOP8)	8	2	-40°C ~125°C	RS122	Tape and Reel,4000
RS122XM	MSOP-8	8	2	-40°C ~125°C	RS122	Tape and Reel,4000
RS122XTDC8	DFN3x3-8L	8	2	-40°C ~125°C	RS122	Tape and Reel,5000
RS122SXN	MSOP-10	10	2	-40°C ~125°C	RS122S	Tape and Reel,4000
RS124XP	SOIC-14(SOP14)	14	4	-40°C ~125°C	RS124	Tape and Reel,4000
RS124XQ	TSSOP-14	14	4	-40°C ~125°C	RS124	Tape and Reel,4000

**NOTE:**

- (1) This information is the most current data available for the designated devices. This data is subject to change without notice and revision of this document. For browser-based versions of this data sheet, refer to the right-hand navigation.
- (2) There may be additional marking, which relates to the lot trace code information (data code and vendor code), the logo or the environmental category on the device.

## 6 Pin Configuration and Functions (Top View)

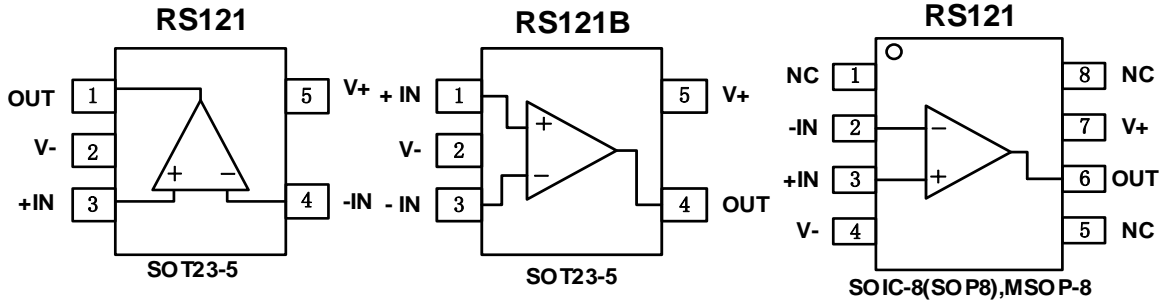

### Pin Description

NAME	PIN			I/O <sup>(1)</sup>	DESCRIPTION
	RS121	RS121B	RS121		
	SOT23-5	SOT23-5	SOIC-8(SOP8)/MSOP-8		
-IN	4	3	2	I	Negative (inverting) input
+IN	3	1	3	I	Positive (noninverting) input
NC <sup>(2)</sup>	-	-	1,5,8	-	No internal connection (can be left floating)
OUT	1	4	6	O	Output
V-	2	2	4	-	Negative (lowest) power supply
V+	5	5	7	-	Positive (highest) power supply

(1) I = Input, O = Output.

(2) There is no internal connection. Typically, GND is the recommended connection to a heat spreading plane.

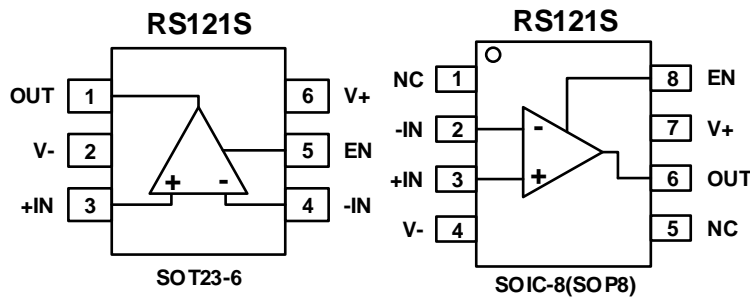

### Pin Description

NAME	PIN		I/O <sup>(1)</sup>	DESCRIPTION
	RS121S			
	SOT23-6	SOIC-8(SOP8)		
-IN	4	2	I	Inverting input
+IN	3	3	I	Noninverting input
OUT	1	6	O	Output
EN	5	8	I	Enable pin. This pin turns the regulator on or off. Low = disabled, high = normal operation (pin must be driven)
NC <sup>(2)</sup>	-	1,5	-	No internal connection (can be left floating)
V-	2	4	-	Negative (lowest) power supply
V+	6	7	-	Positive (highest) power supply

(1) I = Input, O = Output.

(2) There is no internal connection. Typically, GND is the recommended connection to a heat spreading plane.

## Pin Configuration and Functions (Top View)

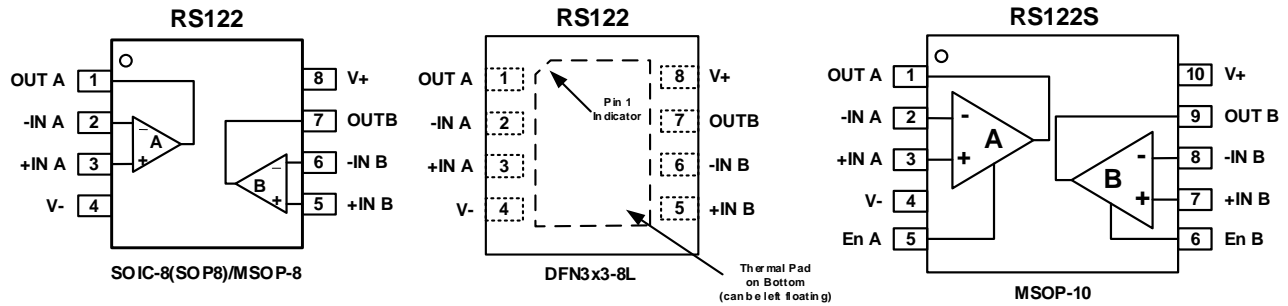

## Pin Description

NAME	PIN		I/O <sup>(1)</sup>	DESCRIPTION
	RS122	RS122S		
	SOIC-8(SOP8)/ MSOP-8/ DFN3x3-8L	MSOP-10		
-INA	2	2	I	Inverting input, channel A
+INA	3	3	I	Noninverting input, channel A
-INB	6	8	I	Inverting input, channel B
+INB	5	7	I	Noninverting input, channel B
OUTA	1	1	O	Output, channel A
OUTB	7	9	O	Output, channel B
EnA	-	5	I	Enable pin, channel A. This pin turns the regulator on or off. Low = disabled, high = normal operation (pin must be driven)
EnB	-	6	I	Enable pin, channel B. This pin turns the regulator on or off. Low = disabled, high = normal operation (pin must be driven)
V-	4	4	-	Negative (lowest) power supply
V+	8	10	-	Positive (highest) power supply
-	Thermal Pad	-	-	Connect thermal pad to V-

(1) I = Input, O = Output.

## Pin Configuration and Functions (Top View)

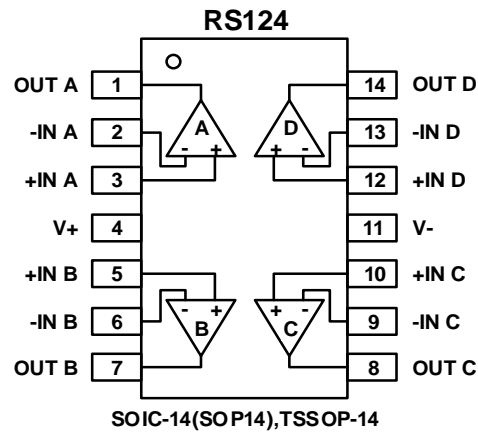

### Pin Description

NAME	PIN	I/O <sup>(1)</sup>	DESCRIPTION
	SOIC-14(SOP14)/TSSOP-14		
-INA	2	I	Inverting input, channel A
+INA	3	I	Noninverting input, channel A
-INB	6	I	Inverting input, channel B
+INB	5	I	Noninverting input, channel B
-INC	9	I	Inverting input, channel C
+INC	10	I	Noninverting input, channel C
-IND	13	I	Inverting input, channel D
+IND	12	I	Noninverting input, channel D
OUTA	1	O	Output, channel A
OUTB	7	O	Output, channel B
OUTC	8	O	Output, channel C
OUTD	14	O	Output, channel D
V-	11	-	Negative (lowest) power supply
V+	4	-	Positive (highest) power supply

(1) I = Input, O = Output.

## 7 SPECIFICATIONS

### 7.1 Absolute Maximum Ratings

Over operating free-air temperature range (unless otherwise noted) <sup>(1)</sup>

		MIN	MAX	UNIT
Voltage	Supply, $V_s=(V+) - (V-)$		7	V
	Signal input pin <sup>(2)</sup>	(V-)-0.5	(V+) +0.5	
	Signal output pin <sup>(3)</sup>	(V-)-0.5	(V+) +0.5	
Current	Signal input pin <sup>(2)</sup>	-10	10	mA
	Signal output pin <sup>(3)</sup>	-50	50	mA
	Output short-circuit <sup>(4)</sup>	Continuous		
$\theta_{JA}$	Package thermal impedance <sup>(5)</sup>	SOT23-5	230	°C/W
		SOIC-8(SOP8)	110.88	
		MSOP-8	165.7	
		SOIC-14(SOP14)	104.5	
		TSSOP-14	89.21	
		SOT23-6	230	
		DFN3x3-8L	43	
		MSOP-10	200	
Temperature	Operating range, $T_A$	-40	125	°C
	Junction, $T_J$ <sup>(6)</sup>	-40	150	
	Storage, $T_{stg}$	-65	150	

(1) Stresses above these ratings may cause permanent damage. Exposure to absolute maximum conditions for extended periods may degrade device reliability. These are stress ratings only, and functional operation of the device at these or any other conditions beyond those specified is not implied.

(2) Input terminals are diode-clamped to the power-supply rails. Input signals that can swing more than 0.5V beyond the supply rails should be current-limited to 10mA or less.

(3) Output terminals are diode-clamped to the power-supply rails. Output signals that can swing more than 0.5V beyond the supply rails should be current-limited to  $\pm 50$ mA or less.

(4) Short-circuit to ground, one amplifier per package.

(5) The package thermal impedance is calculated in accordance with JESD-51.

(6) The maximum power dissipation is a function of  $T_{J(MAX)}$ ,  $R_{\theta JA}$ , and  $T_A$ . The maximum allowable power dissipation at any ambient temperature is  $P_D = (T_{J(MAX)} - T_A) / R_{\theta JA}$ . All numbers apply for packages soldered directly onto a PCB.

### 7.2 ESD Ratings

The following ESD information is provided for handling of ESD-sensitive devices in an ESD protected area only.

			VALUE	UNIT
$V_{(ESD)}$	Electrostatic discharge	Human-body model (HBM), per ANSI/ESDA/JEDEC JS-001 <sup>(1)</sup>	$\pm 5000$	V
		Machine Model (MM)	$\pm 400$	

(1) JEDEC document JEP155 states that 500 V HBM allows safe manufacturing with a standard ESD control process.



#### ESD SENSITIVITY CAUTION

ESD damage can range from subtle performance degradation to complete device failure. Precision integrated circuits may be more susceptible to damage because very small parametric changes could cause the device not to meet its published specifications.



### 7.3 Recommended Operating Conditions

Over operating free-air temperature range (unless otherwise noted)

		MIN	NOM	MAX	UNIT
Supply voltage , $V_S = (V+) - (V-)$	Single-supply	2.5		5.5	V
	Dual-supply	$\pm 1.25$		$\pm 2.75$	

## 7.4 ELECTRICAL CHARACTERISTICS

(At  $T_A = +25^\circ\text{C}$ ,  $V_S = 5\text{V}$ ,  $R_L = 500\text{k}\Omega$  connected to  $V_S/2$ , and  $V_{OUT} = V_S/2$ ,  $V_{CM} = V_S/2$ , unless otherwise noted.) <sup>(1)</sup>

PARAMETER	CONDITIONS	$T_J$	RS121S, RS122S, RS121, RS122, RS124				
			MIN <sup>(2)</sup>	TYP <sup>(3)</sup>	MAX <sup>(2)</sup>	UNIT	
<b>POWER SUPPLY</b>							
$V_S$	Operating Voltage Range	$25^\circ\text{C}$	2.5		5.5		V
$I_Q$	Quiescent Current/Amplifier	$25^\circ\text{C}$		12			$\mu\text{A}$
PSRR	Power-Supply Rejection Ratio	$V_S = 2.5\text{V to } 5.5\text{V}$ $V_{CM} = (V_-) + 0.5\text{V}$	$25^\circ\text{C}$	68	95		dB
<b>INPUT</b>							
$V_{OS}$	Input Offset Voltage	$V_{CM} = V_S/2$	$25^\circ\text{C}$	-5	$\pm 0.8$	5	mV
$I_B$	Input Bias Current <sup>(4) (5)</sup>		$25^\circ\text{C}$		$\pm 1$	$\pm 10$	pA
$I_{OS}$	Input Offset Current <sup>(4)</sup>		$25^\circ\text{C}$		$\pm 1$	$\pm 10$	pA
$V_{CM}$	Common-Mode Voltage Range	$V_S = 5.5\text{V}$	$25^\circ\text{C}$	-0.1		5.6	V
CMRR	Common-Mode Rejection Ratio	$V_S = 5.5\text{V}$ $V_{CM} = -0.1\text{V to } 4\text{V}$	$25^\circ\text{C}$	72	95		dB
		$V_S = 5.5\text{V}$ $V_{CM} = -0.1\text{V to } 5.6\text{V}$	$25^\circ\text{C}$	62	90		
<b>OUTPUT</b>							
$A_{OL}$	Open-Loop Voltage Gain	$R_L = 500\text{k}\Omega$ $V_O = 0.015\text{V to } 4.985\text{V}$	$25^\circ\text{C}$	92	110		dB
		$R_L = 100\text{k}\Omega$ $V_O = 0.1\text{V to } 4.9\text{V}$	$25^\circ\text{C}$	90	110		
	Output Swing From Rail	$R_L = 2\text{k}\Omega$	$25^\circ\text{C}$		3		mV
$I_{OUT}$	Output Short-Circuit Current <sup>(6) (7)</sup>		$25^\circ\text{C}$		$\pm 25$		mA
<b>FREQUENCY RESPONSE</b>							
SR	Slew Rate <sup>(8)</sup>		$25^\circ\text{C}$		0.05		V/ $\mu\text{s}$
GBP	Gain-Bandwidth Product		$25^\circ\text{C}$		0.15		MHz
<b>NOISE</b>							
$e_n$	Input Voltage Noise Density	$f = 1\text{KHz}$	$25^\circ\text{C}$		77		nV/ $\sqrt{\text{Hz}}$
		$f = 10\text{KHz}$	$25^\circ\text{C}$		39		nV/ $\sqrt{\text{Hz}}$
<b>ENABLE/SHUTDOWN(RS121S,RS122S)</b>							
$I_{Q(OFF)}$	Supply Current in Shutdown		$25^\circ\text{C}$		<1		$\mu\text{A}$
$t_{OFF}$			$25^\circ\text{C}$		3		$\mu\text{s}$
$t_{ON}$			$25^\circ\text{C}$		20		$\mu\text{s}$
$V_L$	Shut Down		$25^\circ\text{C}$	$V_-$		$(V_-) + 0.8$	V
$V_H$	Amplifier Is Active		$25^\circ\text{C}$	$(V_-) + 2$		$V_+$	V

NOTE:

- Electrical table values apply only for factory testing conditions at the temperature indicated. Factory testing conditions result in very limited self-heating of the device.
- Limits are 100% production tested at  $25^\circ\text{C}$ . Limits over the operating temperature range are ensured through correlations using statistical quality control (SQC) method.
- Typical values represent the most likely parametric norm as determined at the time of characterization. Actual typical values may vary over time and will also depend on the application and configuration.
- This parameter is ensured by design and/or characterization and is not tested in production.
- Positive current corresponds to current flowing into the device.
- The maximum power dissipation is a function of  $T_{J(MAX)}$ ,  $R_{\theta JA}$ , and  $T_A$ . The maximum allowable power dissipation at any ambient temperature is  $PD = (T_{J(MAX)} - T_A) / R_{\theta JA}$ . All numbers apply for packages soldered directly onto a PCB.
- Short circuit test is a momentary test.
- Number specified is the slower of positive and negative slew rates.

## 7.5 TYPICAL CHARACTERISTICS

NOTE: The graphs and tables provided following this note are a statistical summary based on a limited number of samples and are provided for informational purposes only.

At  $T_A = +25^\circ\text{C}$ ,  $V_S = 5\text{V}$ ,  $R_L = 500\text{k}\Omega$  connected to  $V_S/2$ ,  $V_{OUT} = V_S/2$ , unless otherwise noted.

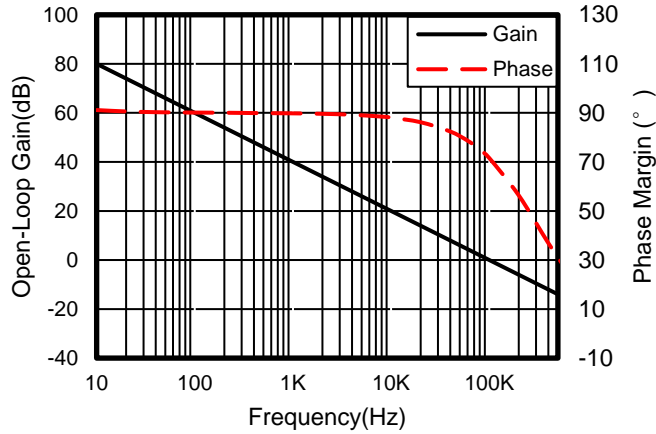

Figure 1. Open-Loop Gain and Phase vs Frequency

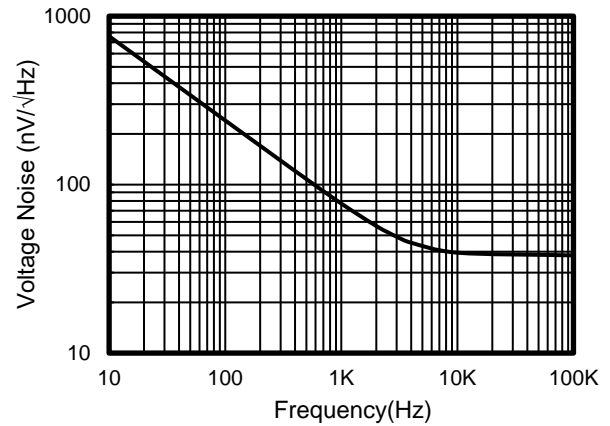

Figure 2. Input Voltage Noise Spectral Density vs Frequency

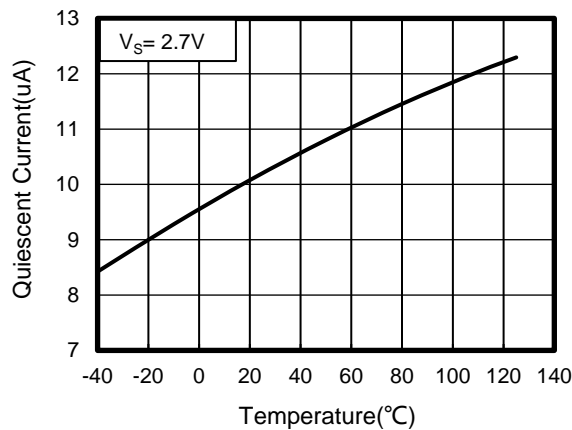

Figure 3. Quiescent Current vs Temperature

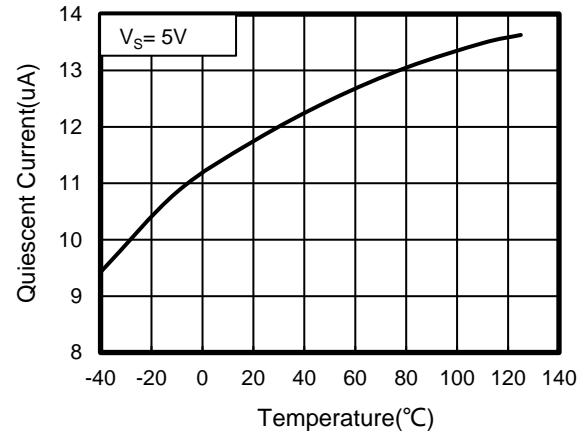

Figure 4. Quiescent Current vs Temperature

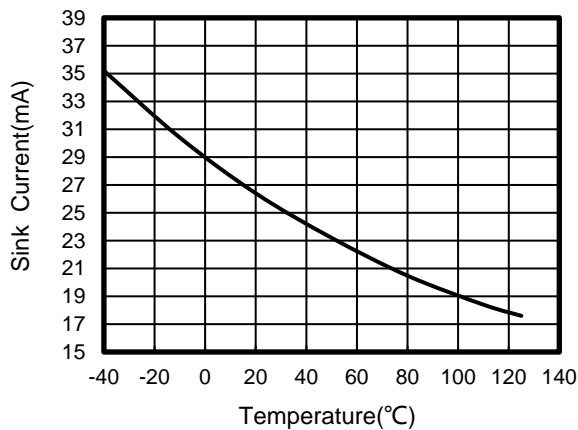

Figure 5. Sink Current vs Temperature

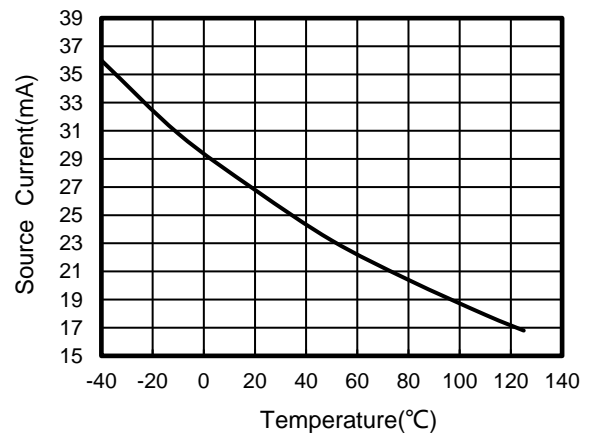

Figure 6. Source Current vs Temperature

## TYPICAL CHARACTERISTICS

NOTE: The graphs and tables provided following this note are a statistical summary based on a limited number of samples and are provided for informational purposes only.

At  $T_A = +25^\circ\text{C}$ ,  $V_S = 5\text{V}$ ,  $R_L = 500\text{k}\Omega$  connected to  $V_S/2$ ,  $V_{OUT} = V_S/2$ , unless otherwise noted.

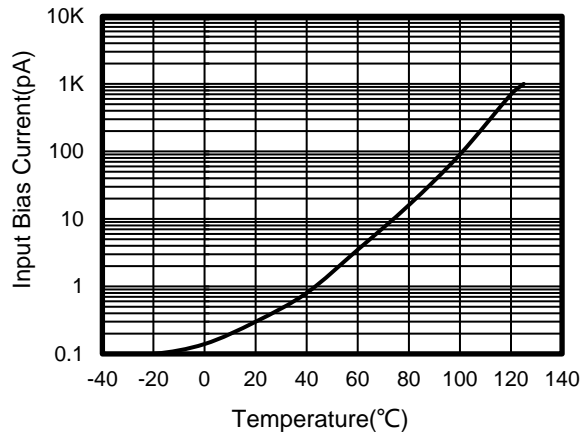

Figure 7. Input Bias Current vs Temperature

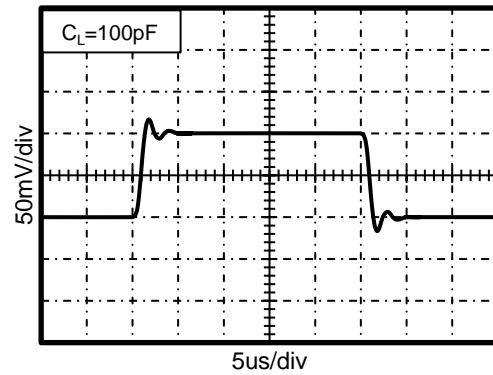

Figure 8. Small-Signal Step Response

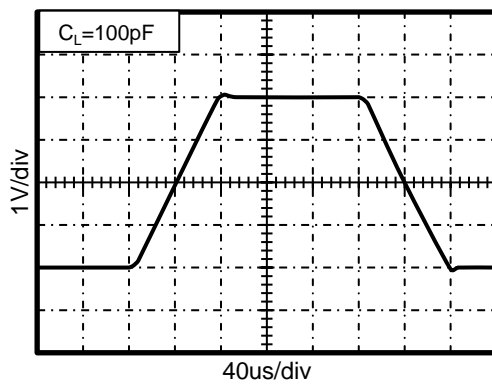

Figure 9. Large-Signal Step Response

## 8 Application and Implementation

Information in the following applications sections is not part of the Runic component specification, and Runic does not warrant its accuracy or completeness. Runic's customers are responsible for determining suitability of components for their purposes. Customers should validate and test their design implementation to confirm system functionality.

### 8.1 APPLICATION NOTE

The RS121, RS122, RS124, RS121S, RS122S are high precision, rail-to-rail operational amplifiers that can be run from a single-supply voltage 2.5V to 5.5V ( $\pm 1.25V$  to  $\pm 2.75V$ ). Supply voltages higher than 7V (absolute maximum) can permanently damage the amplifier. Rail-to-rail input and output swing significantly increases dynamic range, especially in low-supply applications. Good layout practice mandates use of a 0.1uF capacitor placed closely across the supply pins.

### 8.2 RS121S/RS122S ENABLE FUNCTION

The RS121S/RS122S includes a shutdown mode. Under logic control, the amplifiers can be switched from normal mode to a standby current of 1uA. When the Enable pin is connected to high, the amplifier is active. Connecting Enable low disables the amplifier, and places the amplifier, and place the output in a high-impedance state.

### 8.3 LAYOUT GUIDELINS

Attention to good layout practices is always recommended. Keep traces short. When possible, use a PCB ground plane with surface-mount components placed as close to the device pins as possible. Place a 0.1uF capacitor closely across the supply pins. These guidelines should be applied throughout the analog circuit to improve performance and provide benefits such as reducing the EMI susceptibility.

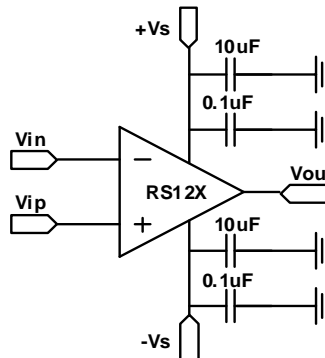

Figure 10. Amplifier with Bypass Capacitors

### 8.4 INSTRUMENTATION AMPLIFIER

In the three-op amp, instrumentation amplifier configuration shown in Figure 11,

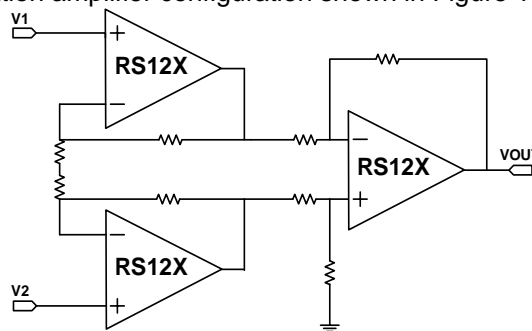
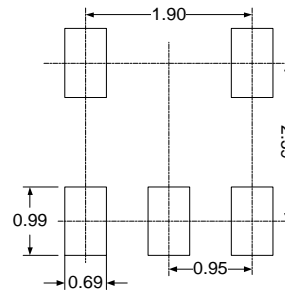
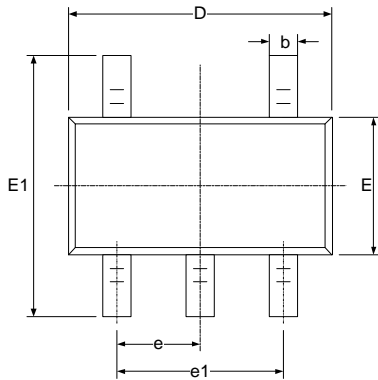
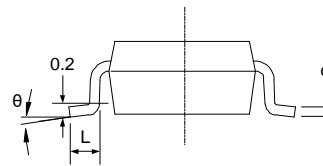
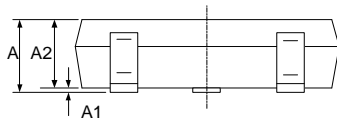

Figure 11. Amplifier instrumentation amplifier

## 9 PACKAGE OUTLINE DIMENSIONS SOT23-5



RECOMMENDED LAND PATTERN (Unit: mm)



Symbol	Dimensions In Millimeters		Dimensions In Inches	
	Min	Max	Min	Max
A	1.050	1.250	0.041	0.049
A1	0.000	0.100	0.000	0.004
A2	1.050	1.150	0.041	0.045
b	0.300	0.500	0.012	0.020
c	0.100	0.200	0.004	0.008
D	2.820	3.020	0.111	0.119
E	1.500	1.700	0.059	0.067
E1	2.650	2.950	0.104	0.116
e	0.950(BSC)		0.037(BSC)	
e1	1.800	2.000	0.071	0.079
L	0.300	0.600	0.012	0.024
$\theta$	0°	8°	0°	8°

SOT23-6

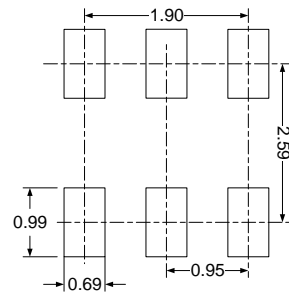
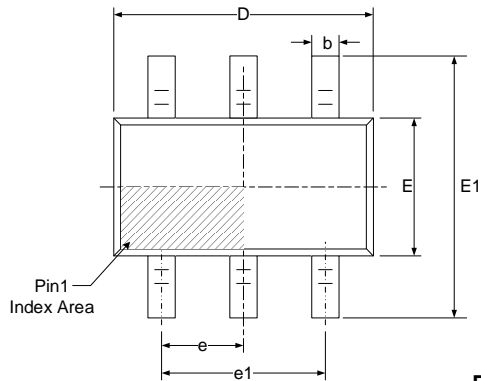

RECOMMENDED LAND PATTERN (Unit: mm)

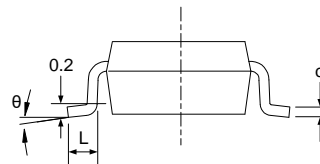
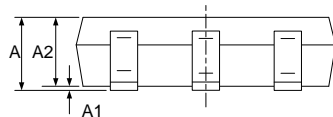

Symbol	Dimensions In Millimeters		Dimensions In Inches	
	Min	Max	Min	Max
A	1.050	1.250	0.041	0.049
A1	0.000	0.100	0.000	0.004
A2	1.050	1.150	0.041	0.045
b	0.300	0.500	0.012	0.020
c	0.100	0.200	0.004	0.008
D	2.820	3.020	0.111	0.119
E	1.500	1.700	0.059	0.067
E1	2.650	2.950	0.104	0.116
e	0.950(BSC)		0.037(BSC)	
e1	1.800	2.000	0.071	0.079
L	0.300	0.600	0.012	0.024
$\theta$	0°	8°	0°	8°

MSOP-10

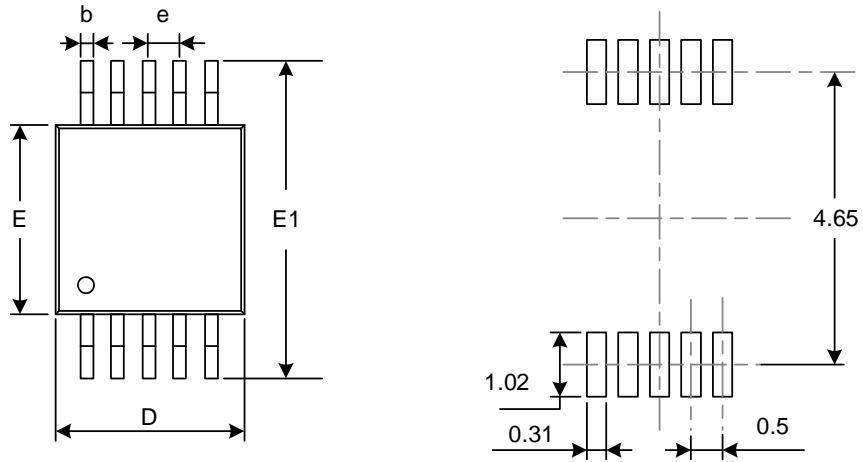

RECOMMENDED LAND PATTERN (Unit: mm)

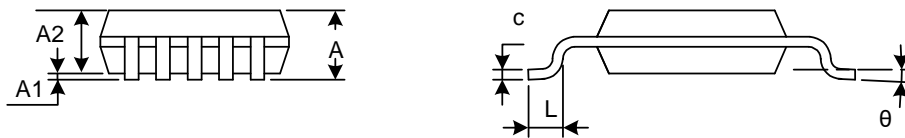

Symbol	Dimensions In Millimeters		Dimensions In Inches	
	Min	Max	Min	Max
A	0.820	1.100	0.032	0.043
A1	0.020	0.150	0.001	0.006
A2	0.750	0.950	0.030	0.037
b	0.180	0.280	0.007	0.011
c	0.090	0.230	0.004	0.009
D	2.900	3.100	0.114	0.122
e	0.50(BSC)		0.020(BSC)	
E	2.900	3.100	0.114	0.122
E1	4.750	5.050	0.187	0.199
L	0.400	0.800	0.016	0.031
θ	0°	6°	0°	6°



MSOP-8

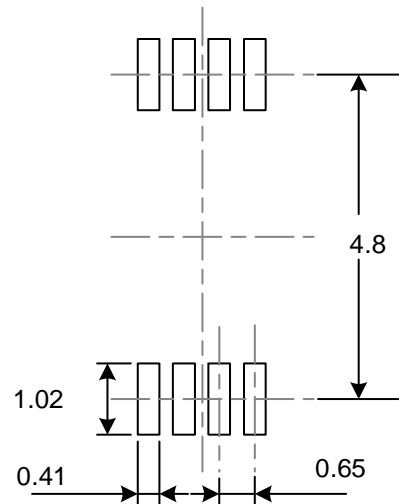
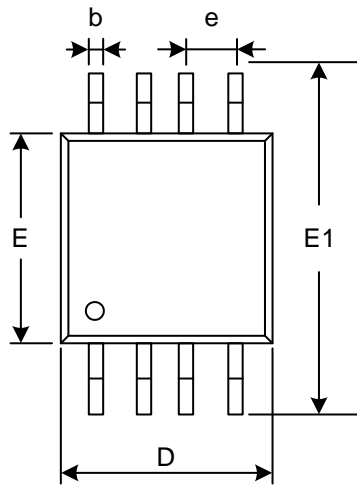

RECOMMENDED LAND PATTERN (Unit: mm)

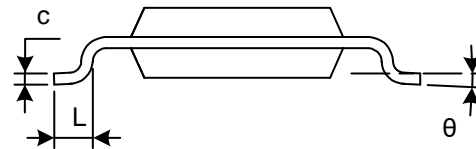
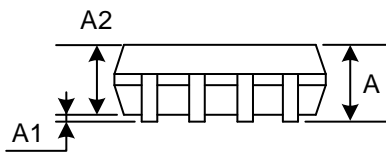

Symbol	Dimensions In Millimeters		Dimensions In Inches	
	Min	Max	Min	Max
A	0.820	1.100	0.032	0.043
A1	0.020	0.150	0.001	0.006
A2	0.750	0.950	0.030	0.037
b	0.250	0.380	0.010	0.015
c	0.090	0.230	0.004	0.009
D	2.900	3.100	0.114	0.122
e	0.650(BSC)		0.026(BSC)	
E	2.900	3.100	0.114	0.122
E1	4.750	5.050	0.187	0.199
L	0.400	0.800	0.016	0.031
$\theta$	0°	6°	0°	6°

TSSOP-14

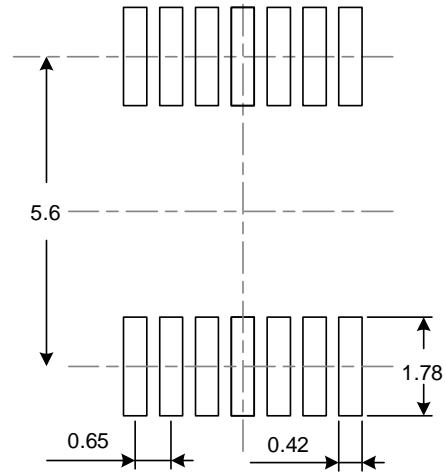
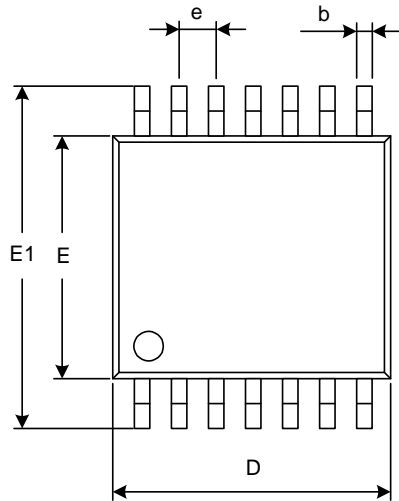

RECOMMENDED LAND PATTERN (Unit: mm)

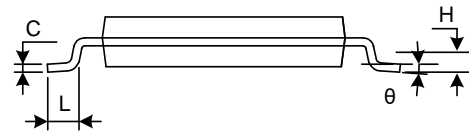
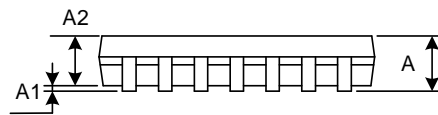

Symbol	Dimensions In Millimeters		Dimensions In Inches	
	Min	Max	Min	Max
A		1.200		0.047
A1	0.050	0.150	0.002	0.006
A2	0.800	1.050	0.031	0.041
b	0.190	0.300	0.007	0.012
c	0.090	0.200	0.004	0.008
D	4.860	5.100	0.191	0.201
E	4.300	4.500	0.169	0.177
E1	6.250	6.550	0.246	0.258
e	0.650(BSC)		0.026(BSC)	
L	0.500	0.700	0.020	0.028
H	0.25(TYP)		0.01(TYP)	
$\theta$	1°	7°	1°	7°

SOIC-8 (SOP8)

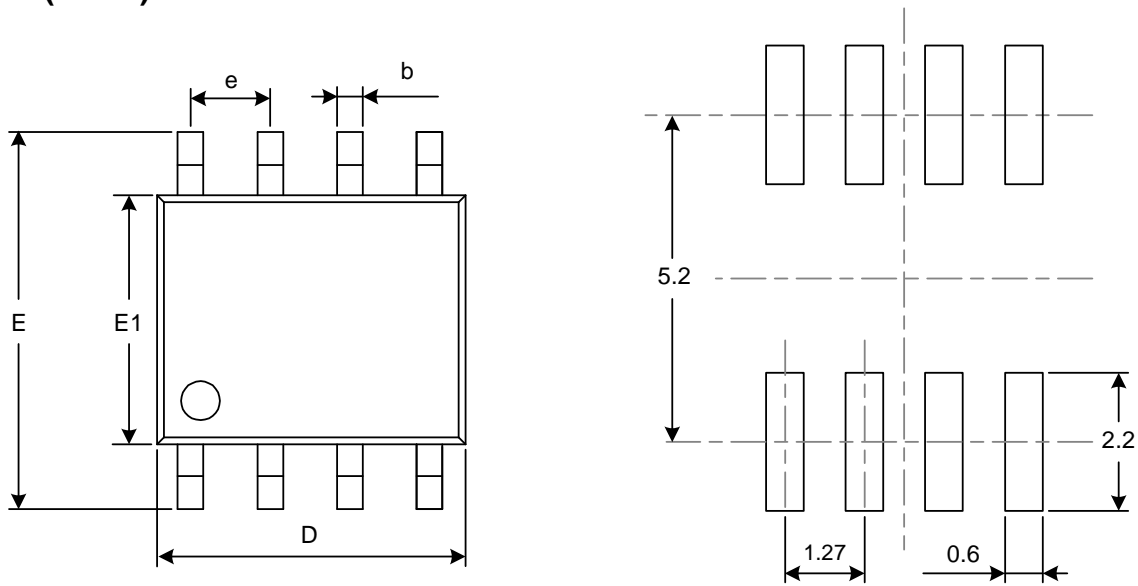

RECOMMENDED LAND PATTERN (Unit: mm)

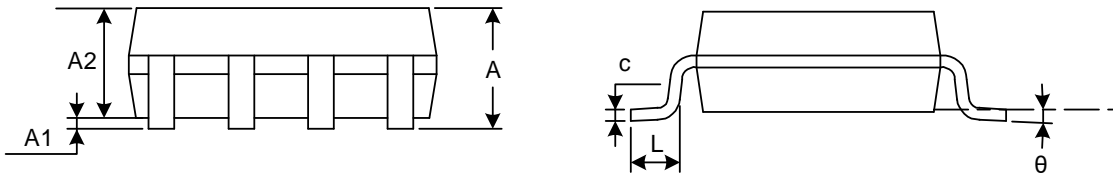

Symbol	Dimensions In Millimeters		Dimensions In Inches	
	Min	Max	Min	Max
A	1.350	1.750	0.053	0.069
A1	0.100	0.250	0.004	0.010
A2	1.350	1.550	0.053	0.061
b	0.330	0.510	0.013	0.020
c	0.170	0.250	0.007	0.010
D	4.800	5.000	0.189	0.197
e	1.270(BSC)		0.050(BSC)	
E	5.800	6.200	0.228	0.244
E1	3.800	4.000	0.150	0.157
L	0.400	1.270	0.016	0.050
θ	0°	8°	0°	8°

SOIC-14 (SOP14)

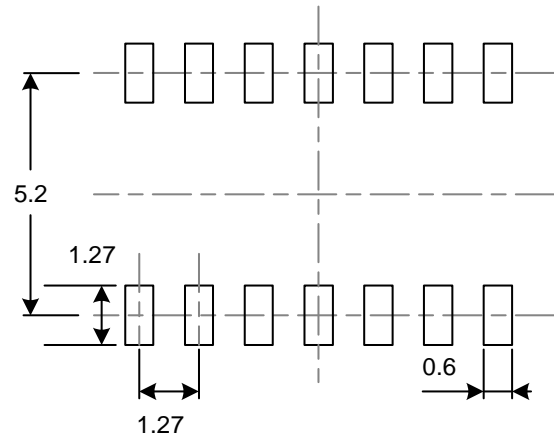
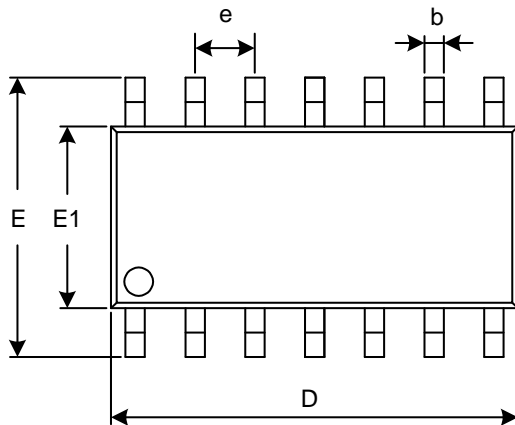

RECOMMENDED LAND PATTERN (Unit: mm)

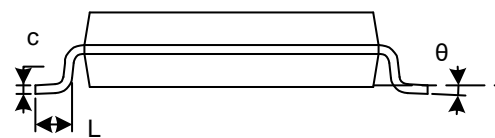
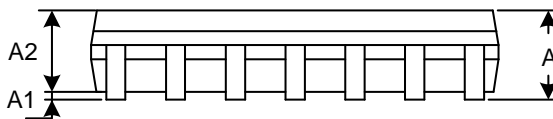

Symbol	Dimensions In Millimeters		Dimensions In Inches	
	Min	Max	Min	Max
A	1.350	1.750	0.053	0.069
A1	0.100	0.250	0.004	0.010
A2	1.350	1.550	0.053	0.061
b	0.310	0.510	0.012	0.020
c	0.100	0.250	0.004	0.010
D	8.450	8.850	0.333	0.348
e	1.270(BSC)		0.050(BSC)	
E	5.800	6.200	0.228	0.244
E1	3.800	4.000	0.150	0.157
L	0.400	1.270	0.016	0.050
$\theta$	0°	8°	0°	8°

DFN3x3-8L

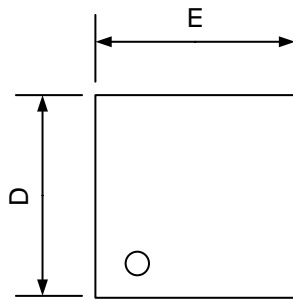

TOP VIEW

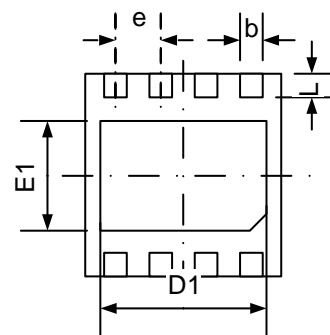

BOTTOM VIEW

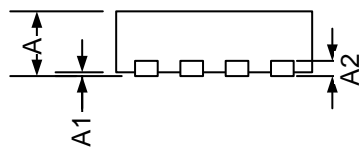

SIDE VIEW

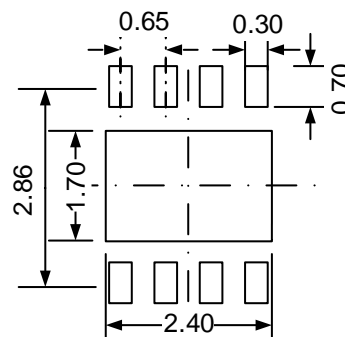

RECOMMENDED LAND PATTERN (Unit: mm)

Symbol	Dimensions In Millimeters		Dimensions In Inches	
	Min	Max	Min	Max
A	0.700	0.800	0.028	0.031
A1	0.000	0.050	0.000	0.002
A2	0.203		0.008	
b	0.250	0.350	0.010	0.014
D	2.900	3.100	0.114	0.122
D1	2.350	2.450	0.093	0.096
E	2.900	3.100	0.114	0.122
E1	1.650	1.750	0.065	0.069
e	0.650 TYP		0.026 TYP	
L	0.370	0.470	0.015	0.019

NOTE:

- A. All linear dimension is in millimeters.
- B. This drawing is subject to change without notice.
- C. Body dimensions do not include mold flash or protrusion. Mold flash and protrusion shall not exceed 0.15 per side.
- D. BSC: Basic Dimension. Theoretically exact value shown without tolerances.

## 10 TAPE AND REEL INFORMATION REEL DIMENSIONS

## TAPE DIMENSION

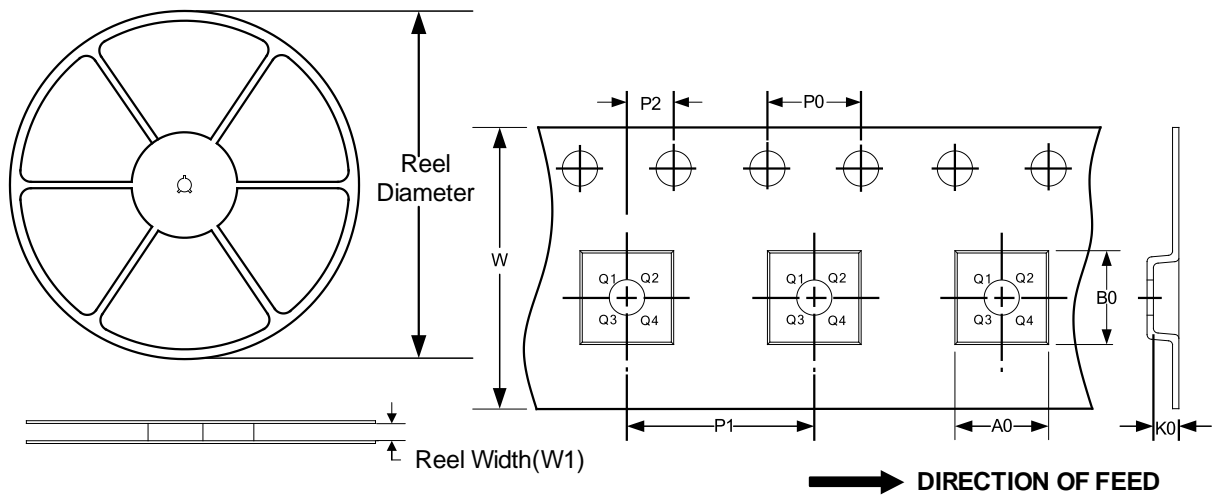

NOTE: The picture is only for reference. Please make the object as the standard.

### KEY PARAMETER LIST OF TAPE AND REEL

Package Type	Reel Diameter	Reel Width (mm)	A0 (mm)	B0 (mm)	K0 (mm)	P0 (mm)	P1 (mm)	P2 (mm)	W (mm)	Pin1 Quadrant
SOT23-5	7"	9.5	3.20	3.20	1.40	4.0	4.0	2.0	8.0	Q3
SOT23-6	7"	9.5	3.17	3.23	1.37	4.0	4.0	2.0	8.0	Q3
MSOP-10	13"	12.4	5.20	3.30	1.20	4.0	8.0	2.0	12.0	Q1
MSOP-8	13"	12.4	5.20	3.30	1.50	4.0	8.0	2.0	12.0	Q1
TSSOP-14	13"	12.4	6.95	5.60	1.20	4.0	8.0	2.0	12.0	Q1
SOIC-8 (SOP8)	13"	12.4	6.40	5.40	2.10	4.0	8.0	2.0	12.0	Q1
SOIC-14 (SOP14)	13"	16.4	6.60	9.30	2.10	4.0	8.0	2.0	16.0	Q1
DFN3x3-8L	13"	12.4	3.35	3.35	1.13	4.0	8.0	2.0	12.0	Q1

NOTE:

1. All dimensions are nominal.
2. Plastic or metal protrusions of 0.15mm maximum per side are not included.

## **IMPORTANT NOTICE AND DISCLAIMER**

Jiangsu Runic Technology Co., Ltd. will accurately and reliably provide technical and reliability data (including data sheets), design resources (including reference designs), application or other design advice, WEB tools, safety information and other resources, without warranty of any defect, and will not make any express or implied warranty, including but not limited to the warranty of merchantability. Implied warranty that it is suitable for a specific purpose or does not infringe the intellectual property rights of any third party.

These resources are intended for skilled developers designing with Runic products. You will be solely responsible for: (1) Selecting the appropriate products for your application; (2) Designing, validating and testing your application; (3) Ensuring your application meets applicable standards and any other safety, security or other requirements; (4) Runic and the Runic logo are registered trademarks of Runic Incorporated. All trademarks are the property of their respective owners; (5) For change details, review the revision history included in any revised document. The resources are subject to change without notice. Our company will not be liable for the use of this product and the infringement of patents or third-party intellectual property rights due to its use.