



PxxxxSDT-3L TSS

Rev.1.4

DESCRIPTION

PxxxxSDT-3L series are a type of semiconductor components. They can be used to replace the traditional GDT and TVS combination solution RS485, they have small dimension, low capacitance etc.

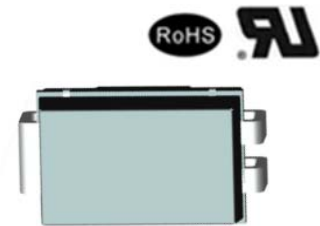

SMC-3

FEATURES

- ✧ Glass passivated junction.
- ✧ Excellent capability of absorbing transient surge.
- ✧ Quick response to surge voltage (ns Level).
- ✧ Eliminates overvoltage caused by fast rising transients.
- ✧ Lead free in compliance with EU RoHS 2011/65/EU directive.
- ✧ Moisture sensitivity level: Level 1.
- ✧ UL 497B item recognized. (File No.: E480698).
- ✧ IEC61000-4-2 (ESD) $\pm 30\text{kV}$ (air), $\pm 30\text{kV}$ (contact).
- ✧ Non degenerative.

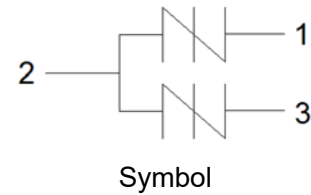

ABSOLUTE MAXIMUM RATINGS ($T_A=25^\circ\text{C}$, RH=45%-75%, unless otherwise noted)

Parameter	Symbol	Value	Unit
Storage temperature range	T_{STG}	-60 to +150	$^\circ\text{C}$
Operating junction temperature range	T_J	-40 to +125	$^\circ\text{C}$
Operating ambient temperature range	T_A	-40 to +125	$^\circ\text{C}$
Peak pulse current@1.2/50 μs -8/20 μs @2 Ω (Note 1)	I_{PP}	3000	A

Notes: 1. Surge rating: 3000A@1.2/50 μs -8/20 μs @2 Ω (PIN 1 or 3 to 2)

ELECTRICAL CHARACTERISTICS($T_A=25^{\circ}\text{C}$)

Symbol	Parameter
V_{DRM}	Peak off-state voltage
I_{DRM}	Off-state current
V_{S}	Switching voltage
I_{S}	Switching current
V_{T}	On-state voltage
I_{T}	On-state current
I_{H}	Holding current
C_{O}	Off-state capacitance

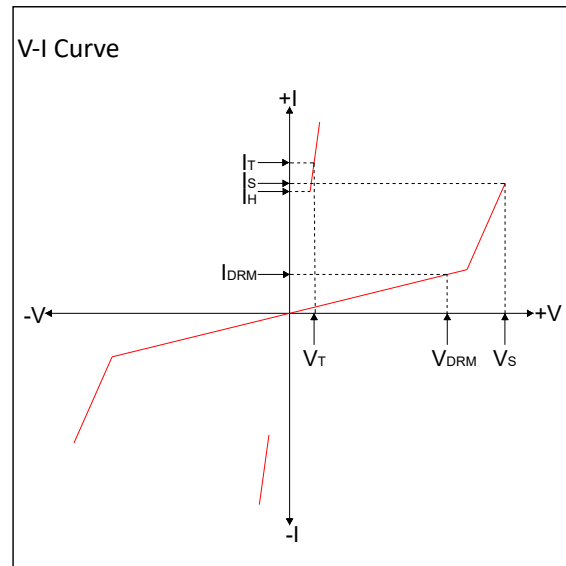

MARKING



P08T: Device Marking Code
2009: In ninth week, 2020

ELECTRICAL CHARACTERISTICS($T_A=125^{\circ}\text{C}$)

Part Number	$I_{\text{DRM}}@V_{\text{DRM}}$		$V_{\text{S}}^{\text{①}}@I_{\text{S}}$		$V_{\text{T}}@I_{\text{T}}$		I_{H}	$C_{\text{O}}^{\text{②}}$		Marking
	μA	V	V	mA	V	A	mA	pF		
	max	Pin 1,3-2	Pin 1,3-2	max	max	max	min	min	max	
P0080SDT-3L	20	6	15	800	4	2.2	35	400	700	P08T
P0150SDT-3L	20	15	25	800	4	2.2	35	100	400	P15T

① V_{S} is measured at $100\text{V}/\mu\text{s}$

②Off-state capacitance is measured in $V_{\text{DC}}=2\text{V}$, $V_{\text{RMS}}=1\text{V}$, $f=1\text{MHz}$

ORDERING INFORMATION

P Series code P: SIDAC	008 Median voltage	0 0: Bi-direction	S	DT Surge ratings:3000A Package type:SMC-3	-3L 3 Pins
-------------------------------------	------------------------------	-----------------------------	----------	--	----------------------

SOLDERING PARAMETERS

Reflow Condition		Pb-Free assembly (see FIG.2)
Pre Heat	-Temperature Min ($T_{s(min)}$)	+150°C
	-Temperature Max($T_{s(max)}$)	+200°C
	-Time (Min to Max) (ts)	60-180 secs.
Average ramp up rate (Liquidus Temp (T_L) to peak)		3°C/sec. Max
$T_{s(max)}$ to T_L - Ramp-up Rate		3°C/sec. Max
Reflow	-Temperature(T_L) (Liquidus)	+217°C
	-Temperature(t_L)	60-150 secs.
Peak Temp (T_p)		+260(+0/-5)°C
Time within 5°C of actual Peak Temp (t_p)		30 secs. Max
Ramp-down Rate		6°C/sec. Max
Time 25°C to Peak Temp (T_P)		8 min. Max
Do not exceed		+260°C

FIG.1: Pulse waveform

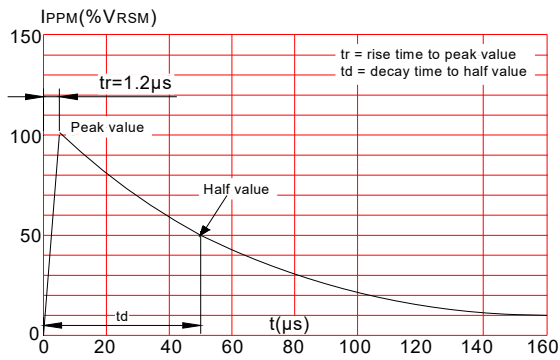

FIG.3: Normalized Vs change vs. junction temperature

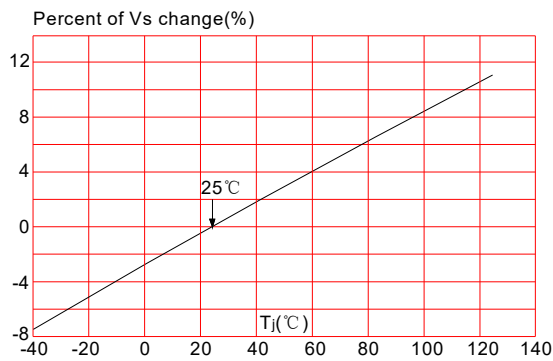

FIG.2: Reflow condition

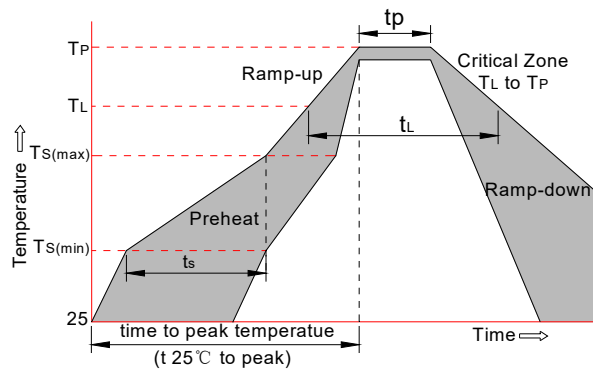
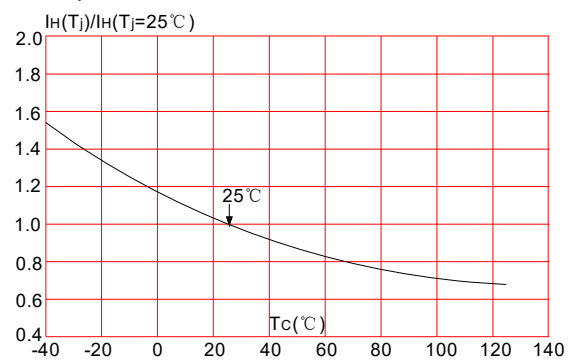
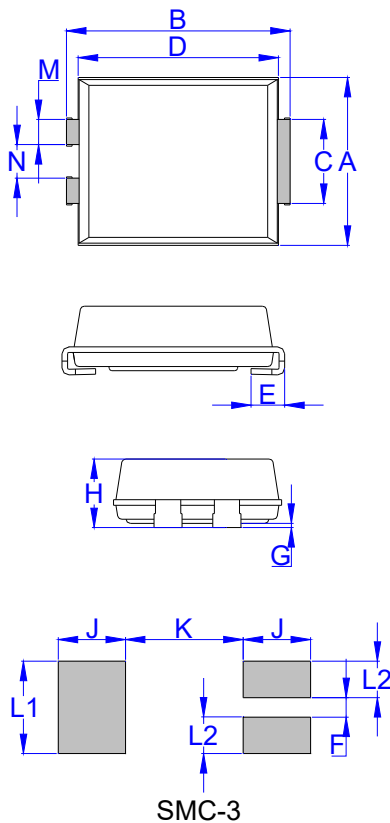

FIG.4: Normalized DC holding current vs. case temperature



PACKAGE MECHANICAL DATA



Ref.	Dimensions			
	Millimeters		Inches	
	Min.	Max.	Min.	Max.
A	5.75	6.25	0.226	0.246
B	7.70	8.20	0.303	0.323
C	2.75	3.25	0.108	0.128
D	6.90	7.40	0.272	0.291
E	0.95	1.52	0.037	0.060
G	-	0.30	-	0.012
H	2.15	2.62	0.085	0.103
M	0.70	1.10	0.028	0.043
N	1.00	1.40	0.039	0.055
L2	1.30		0.051	
F	0.70		0.028	
J	2.40		0.094	
K		4.20		0.165
L1	3.30		0.130	

TAPE AND REEL SPECIFICATION-SMC-3

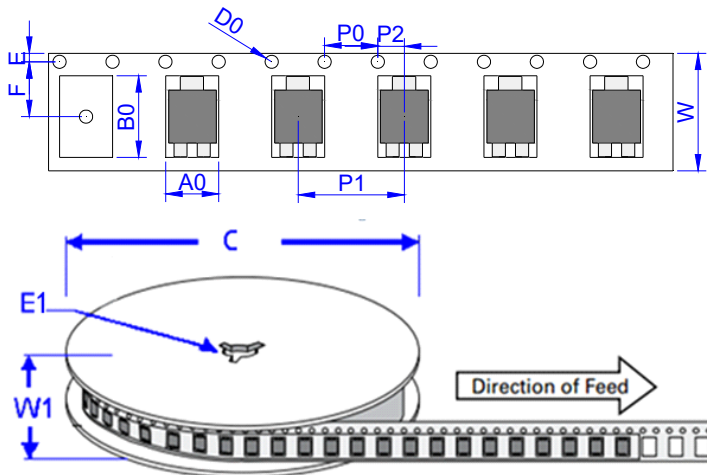

Ref.	Dimensions	
	Millimeters	Inches
A0	6.05 ± 0.3	0.238 ± 0.012
B0	8.31 ± 0.3	0.327 ± 0.012
C	330.0	13.0
D0	1.55 ± 0.1	0.061 ± 0.004
E	1.75 ± 0.2	0.069 ± 0.008
E1	13.3 ± 0.3	0.524 ± 0.012
F	7.50 ± 0.2	0.295 ± 0.008
P0	4.00 ± 0.2	0.157 ± 0.008
P1	8.00 ± 0.2	0.3145 ± 0.008
P2	2.00 ± 0.2	0.079 ± 0.008
W	16.0 ± 0.2	0.630 ± 0.008
W1	19.7 ± 2.0	0.776 ± 0.079

PART No.	UNIT WEIGHT (g/PCS) typ.	REEL (PCS)	PER CARTON (PCS)	DESCRIPTION
PxxxxSDT-3L	0.33	3,000	48,000	13 inch reel pack

JieJie products are not designed for, and shall not be used for, any purpose (including, without limitation, automotive, military, aerospace, medical, life-saving, life-sustaining or nuclear facility applications, devices intended for surgical implant into the body, or any other application in which the failure or lack of desired operation of the product may result in personal injury, death, or property damage) other than those expressly set forth in applicable JieJie product documentation. Warranties granted by JieJie shall be deemed void for products used for any purpose not expressly set forth in applicable JieJie documentation. JieJie shall not be liable for any claims or damages arising out of products used in applications not expressly intended by JieJie as set forth in applicable JieJie documentation. The sale and use of JieJie products is subject to JieJie terms and conditions of sale, unless otherwise agreed by JieJie.

Information furnished in this document is believed to be accurate and reliable. However, Jiangsu JieJie Microelectronics Co., Ltd. assumes no responsibility for the consequences of use without consideration for such information nor use beyond it. Information mentioned in this document is subject to change without notice, apart from that when an agreement is signed, Jiangsu JieJie complies with the agreement. Products and information provided in this document have no infringement of patents. Jiangsu JieJie assumes no responsibility for any infringement of other rights of third parties which may result from the use of such products and information. This document is the 1.4th version which is made in 13-Mar.-2023. This document supersedes and replaces all information previously supplied.

 is a registered trademark of Jiangsu JieJie Microelectronics Co., Ltd.

Copyright ©2023 Jiangsu JieJie Microelectronics Co., Ltd. Printed All rights reserved.