

MLR120610FR005

1. SCOPE

This specification is applicable to lead free and halogen free of RoHS directive for MLR series metal alloy low-resistance resistor.

2. Type Designation

MLR	1206	10	F	R005
Product Type	Size (Inch)	Rated Power	Tolerance	Resistance
MLR	1206	1.00W	±1%	5mΩ

3. Construction and Physical Dimensions

3.1 Construction

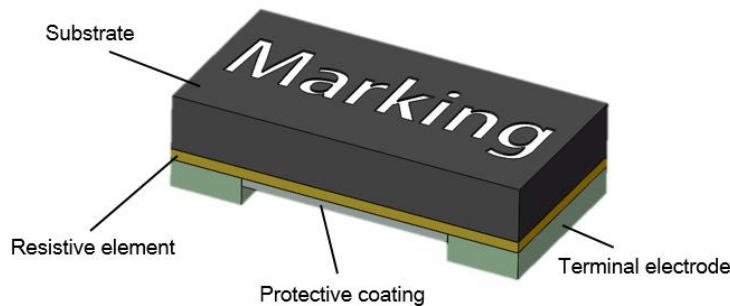

3.2 Physical Dimensions

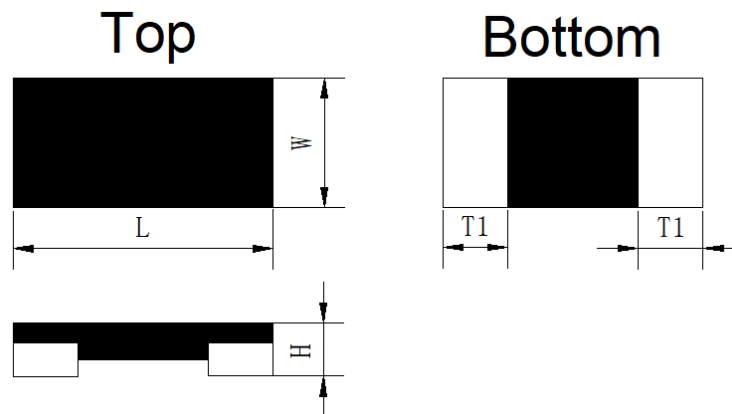

Type	Dimensions (mm)			
	L	W	H	T1
MLR120610FR005	3.20±0.25	1.60±0.25	0.45Max.	0.85±0.35

4. Product Specifications

Type	Max. Rating Power (W)	Resistance Value (mΩ)	Resistance Tolerance	T.C.R (PPM/°C)	Operation Temp. Range (°C)
MLR120610FR005	1.0	5.0	±1%	±100	-55~ + 155

MLR120610FR005

5. Recommended Customer Soldering Parameters

5.1 Recommended IR Reflow Profile

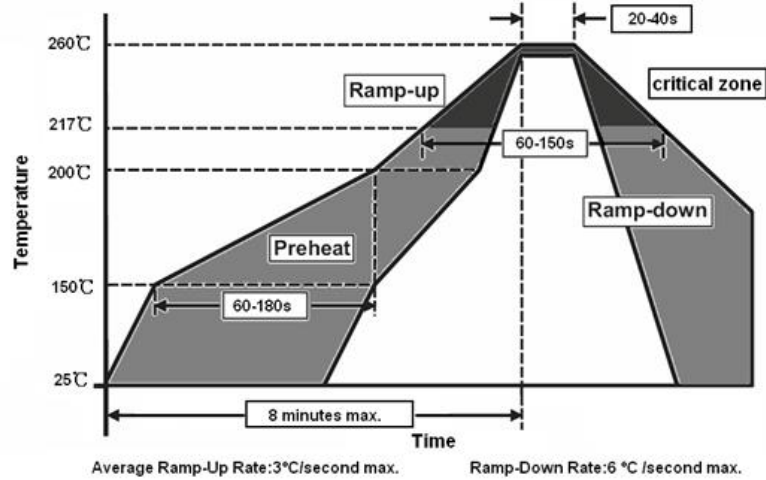

5.2 Recommend Solder Pad Layout

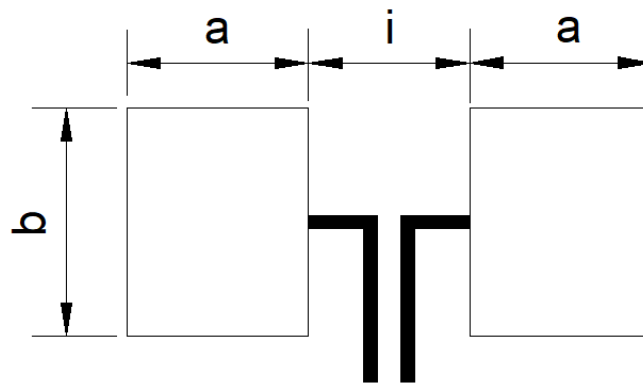

Type	a (mm)	b (mm)	i (mm)
MLR120610FR005	1.35	1.70	1.20

5.3 Recommend Steel Net Layout

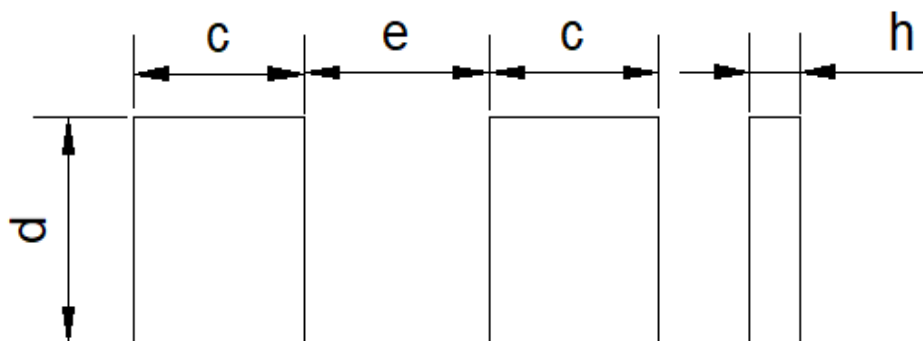

Type	c (mm)	d (mm)	e (mm)	h (mm)
MLR120610FR005	0.85	1.53	1.30	0.08

6. Power Derating Curve

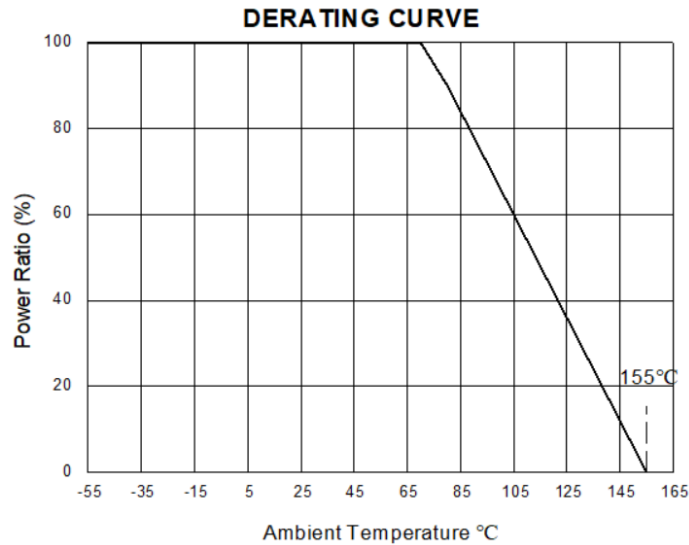

7. Rating Current

The following equation may be used to determine the DC (Direct Current) or AC (Alternating Current) (RMS, root mean square value) of normal rated power. However, if the result value exceeds the highest current of regulated standards, the highest normal rated power is to be used

$$I = \sqrt{P/R}$$

I= Rating current (A)

P= Rating Power (W)

R= Resistance(Ω)

8. Reliability Performance

NO.	Item	Test Method	Test Condition	Specification
1	Temperature Coefficient of Resistance (T.C.R)	JIS C 5201-1 clause 4.8	T.C.R. (ppm/°C) = $\frac{(R2-R1)}{R1(T2-T1)} \times 10^6$ R1: resistance at room temperature (T1) R2: resistance at 125°C (T2)	Refer to Electrical Specification
2	Short Time Overload	JIS C 5201-1 clause 4.13	2.5 times of rated power for 5 sec	ΔR : ±1%
3	High Temperature Exposure	JIS C 5201-1 clause 4.23.2	+ 155°C±2°C for 1000hrs	ΔR : ±1%
4	Low Temperature Storage	JIS C 5201-1 clause 4.23.4	-55°C±2°C for 1000hrs	ΔR : ±1%
5	Load Life	JIS C 5201-1 clause 4.25	Apply rated power at 70±2°C for 1000 hours with 1.5hrs ON and 0.5hrs off	ΔR : ±1%
6	Soldering Heat	JIS C 5201-1 clause 4.18	260±5°C for 10±1 sec	ΔR : ±1%
7	Temperature Cycling	JIS C 5201-1 clause 4.19	-55°C to +155°C , 100cycles	ΔR : ±1%
8	Solderability	JIS C 5201-1 clause 4.17	245±5°C for 3±0.5 sec	Covered area > 95%
9	Bending Strength	JIS C 5201-1 clause 4.33	Chips mounted on a 90mm PCB(FR4) 2 mm bending Bending time: 60±1 seconds	ΔR : ±1%

MLR120610FR005

9. Packaging Information

9.1 Reel Dimensions

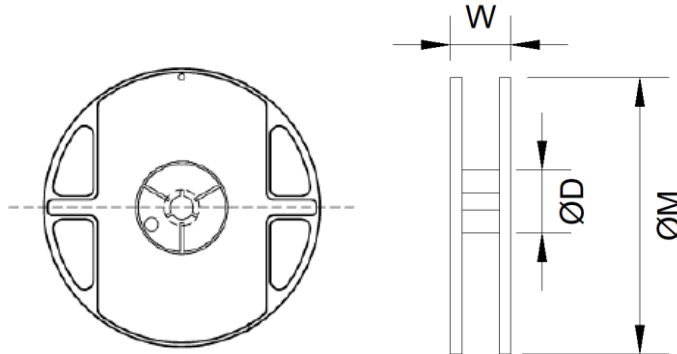

Type	φD (mm)	W (mm)	φM (mm)
MLR120610FR005	60±2	9.0±1	178±5

9.2 Carrier Dimensions (mm)

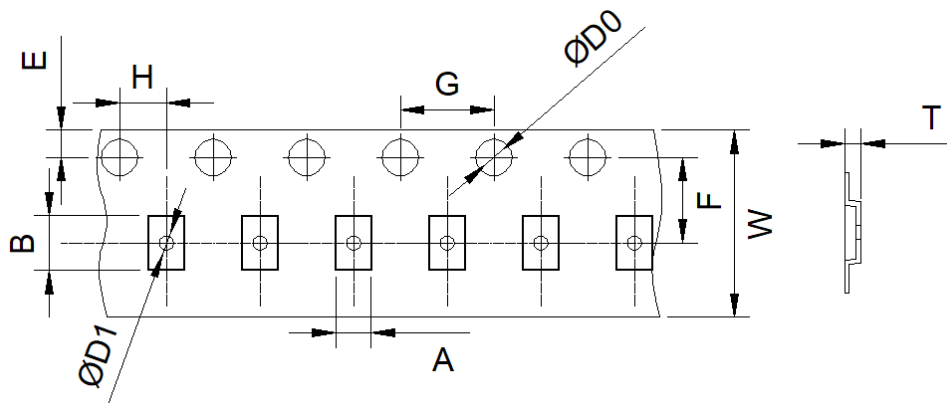

Type	W	P	E	F	φD0	φD1
MLR120610FR005	8.0±0.30	4.0±0.10	1.75±0.10	3.5±0.10	1.5 + 0.10	0.6±0.05
	G	H	A	B	T	
	4.0±0.10	2.0±0.10	2.05±0.20	3.65±0.20	0.60±0.20	

9.3 Peeling Strength of Top Cover Tape

Peeling Strength: 0.1-1.0N at a peel-off speed of 300 mm/min.

9.4 Packaging

TYPE	PCS/Reel
MLR120610FR005	5,000

10. Storage Temperature and Life

Temperature: 5~35°C, Humidity: 60±20%.

When the product is finally discarded, it can be treated as general electronic waste, and raw material compositions of CSR can be referred to MSDS.