

**MLR080505FR003**

## 1. SCOPE

This specification is applicable to lead free and halogen free of RoHS directive for MLR series metal alloy low-resistance resistor.

## 2. Type Designation

MLR	0805	05	F	R003
Product Type	Size (Inch)	Rated Power	Tolerance	Resistance
MLR	0805	0.50W	±1%	3mΩ

## 3. Construction and Physical Dimensions

### 3.1 Construction

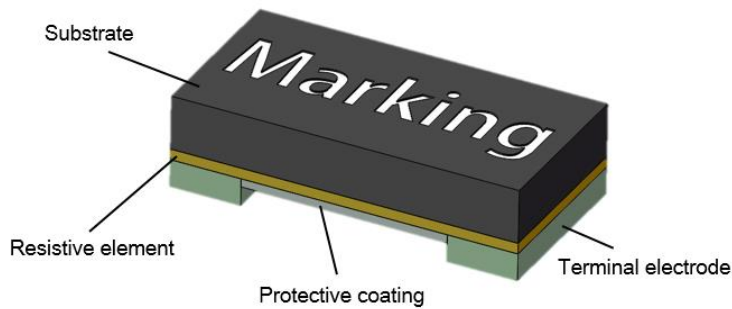

### 3.2 Physical Dimensions

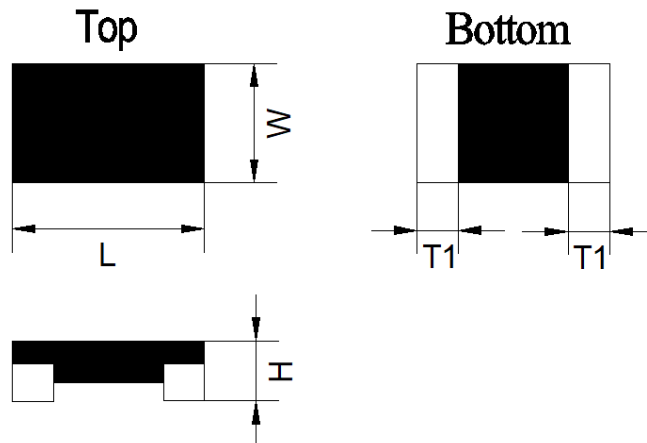

Type	Dimensions (mm)			
	L	W	H	T1
MLR080505FR003	2.00±0.25	1.25±0.25	0.40±0.10	0.40±0.20

## 4. Product Specifications

Type	Max. Rating Power (W)	Resistance Value (mΩ)	Resistance Tolerance	T.C.R (PPM/°C)	Operation Temp. Range (°C)
MLR080505FR003	0.5	3	±1%	±75	-55~ + 155

**MLR080505FR003**

**5. Recommended Customer Soldering Parameters**

**5.1 Recommended IR Reflow Profile**

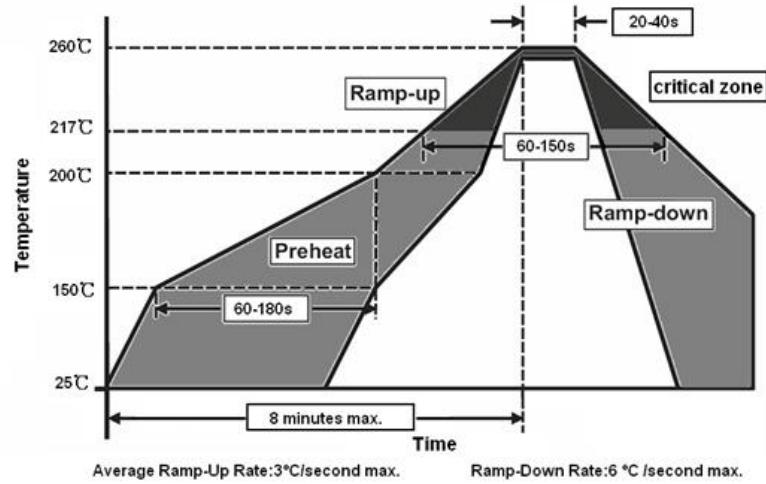

**5.2 Recommend Solder Pad Layout**

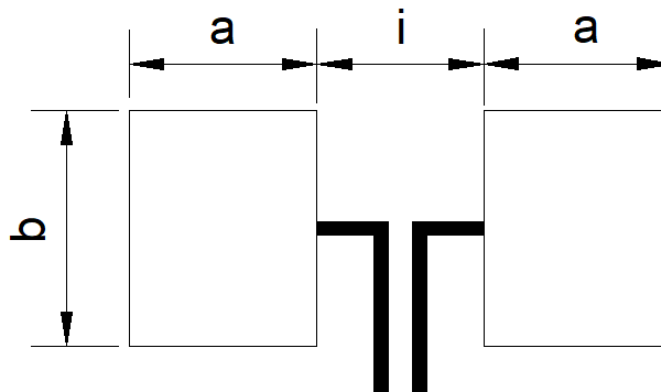

Type	a (mm)	b (mm)	i (mm)
MLR080505FR003	0.85	1.40	1.00

**5.3 Recommend Steel Net Layout**

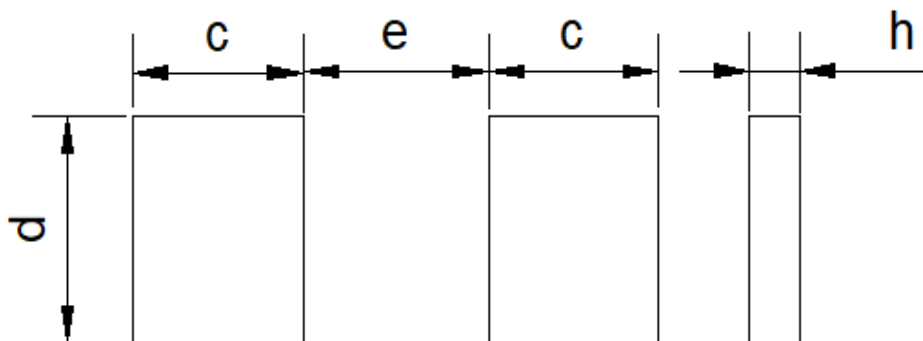

Type	c (mm)	d (mm)	e (mm)	h (mm)
MLR080505FR003	0.41	1.26	1.04	0.08

## 6. Power Derating Curve

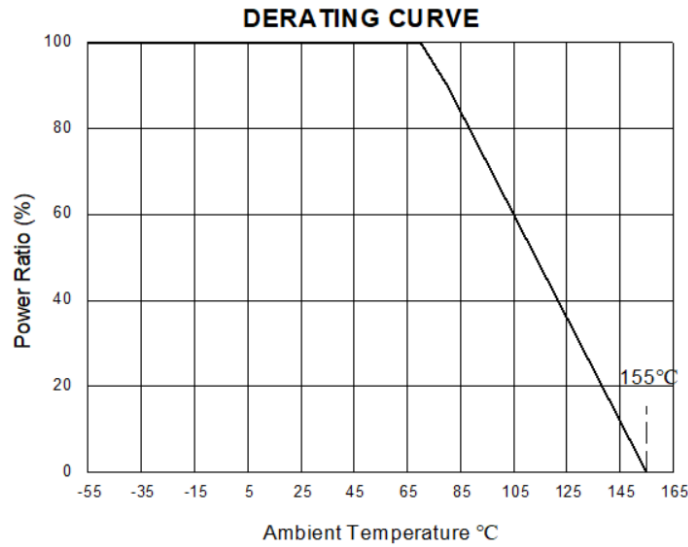

## 7. Rating Current

The following equation may be used to determine the DC (Direct Current) or AC (Alternating Current) (RMS, root mean square value) of normal rated power. However, if the result value exceeds the highest current of regulated standards, the highest normal rated power is to be used

$$I = \sqrt{P/R}$$

I= Rating current (A)

P= Rating Power (W)

R= Resistance(Ω)

## 8. Reliability Performance

NO.	Item	Test Method	Test Condition	Specification
1	Temperature Coefficient of Resistance ( T.C.R )	JIS C 5201-1 clause 4.8	T.C.R. (ppm/°C) = $\frac{(R2-R1)}{R1(T2-T1)} \times 10^6$ R1: resistance at room temperature (T1) R2: resistance at 125°C (T2)	Refer to Electrical Specification
2	Short Time Overload	JIS C 5201-1 clause 4.13	2.5 times of rated power for 5 sec	ΔR : ±1%
3	High Temperature Exposure	JIS C 5201-1 clause 4.23.2	+ 155°C±2°C for 1000hrs	ΔR : ±1%
4	Low Temperature Storage	JIS C 5201-1 clause 4.23.4	-55°C±2°C for 1000hrs	ΔR : ±1%
5	Load Life	JIS C 5201-1 clause 4.25	Apply rated power at 70±2°C for 1000 hours with 1.5hrs ON and 0.5hrs off	ΔR : ±1%
6	Soldering Heat	JIS C 5201-1 clause 4.18	260±5°C for 10±1 sec	ΔR : ±1%
7	Temperature Cycling	JIS C 5201-1 clause 4.19	-55°C to +155°C , 100cycles	ΔR : ±1%
8	Solderability	JIS C 5201-1 clause 4.17	245±5°C for 3±0.5 sec	Covered area > 95%
9	Bending Strength	JIS C 5201-1 clause 4.33	Chips mounted on a 90mm PCB(FR4) 2 mm bending Bending time: 60±1 seconds	ΔR : ±1%

**MLR080505FR003**

**9. Packaging Information**

**9.1 Reel Dimensions**

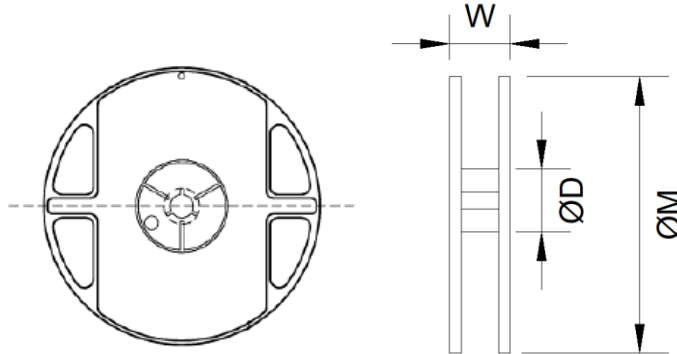

Type	ØD (mm)	W (mm)	ØM (mm)
MLR080505FR003	60±2	9.0±1	178±5

**9.2 Carrier Dimensions (mm)**

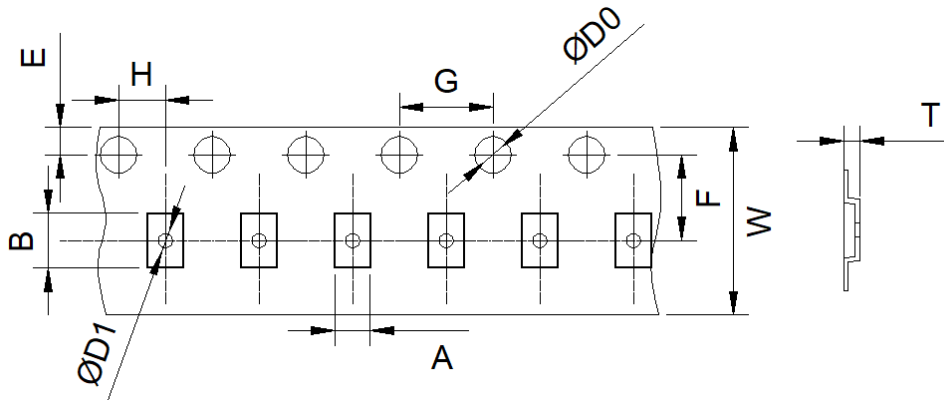

Type	W	P	E	F	ØD0	ØD1
MLR080505FR003	8.0±0.30	4.0±0.10	1.75±0.10	3.5±0.10	1.5 + 0.10	0.6±0.05
	G	H	A	B	T	
	4.0±0.10	2.0±0.10	1.55±0.20	2.30±0.20	0.60±0.20	

**9.3 Peeling Strength of Top Cover Tape**

Peeling Strength: 0.1-1.0N at a peel-off speed of 300 mm/min.

**9.4 Packaging**

TYPE	PCS/Reel
MLR080505FR003	5,000

**10. Storage Temperature**

Temperature: 5~35°C, Humidity: 60±20%

When the product is finally discarded, it can be treated as general electronic waste, and raw material compositions of CSR can be referred to MSDS.