



Description

JMT N And P-Channel Enhancement Mode MOSFET

Features

- N-Channel: 30V, 11.5A
 $R_{DS(ON)} < 12m\Omega @ V_{GS} = 10V$
 $R_{DS(ON)} < 19m\Omega @ V_{GS} = 4.5V$
- P-Channel: -30V, -11.5A
 $R_{DS(ON)} < 24m\Omega @ V_{GS} = -10V$
 $R_{DS(ON)} < 39m\Omega @ V_{GS} = -4.5V$
- Excellent Gate Charge x $R_{DS(ON)}$ Product(FOM)
- Very Low On-resistance $R_{DS(ON)}$
- Fast Switching Speed

Application

- Battery Protection
- Load Switch
- Power Management



100% UIS TESTED!
100% ΔV_{ds} TESTED!

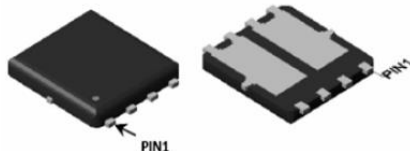

Top View

Bottom View

PDFN5x6-8L-D

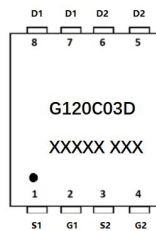

Marking and pin Assignment

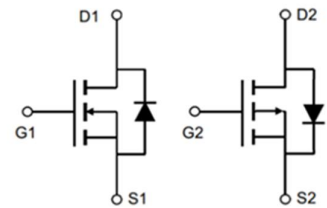

Schematic Diagram

Package Marking and Ordering Information

Device Marking	Device	OUTLINE	Device Package	Reel Size	Reel (PCS)	Per Carton (PCS)
G120C03D	JMTG120C03D	TAPING	PDFN5x6-8L-D	13inch	2500	25000

Absolute Maximum Ratings ($T_C=25^\circ C$ unless otherwise specified)

Symbol	Parameter	Max. N-Channel	Max. P-Channel	Units
V_{DSS}	Drain-Source Voltage	30	-30	V
V_{GSS}	Gate-Source Voltage	± 20	± 20	V
I_D	Continuous Drain Current	$T_C = 25^\circ C$	-11.5	A
		$T_C = 100^\circ C$	-7.5	A
I_{DM}	Pulsed Drain Current ^{note1}	46	46	A
E_{AS}	Single Pulsed Avalanche Energy ^{note2}	20	25	mJ
P_D	Power Dissipation	$T_C = 25^\circ C$	5.4	W
$R_{\theta JC}$	Thermal Resistance, Junction to Ambient	46	23	$^\circ C/W$
T_J, T_{STG}	Operating and Storage Temperature Range	-55 to +150		$^\circ C$



N-Channel Electrical Characteristics (T_J=25°C unless otherwise specified)

Symbol	Parameter	Test Condition	Min.	Typ.	Max.	Units
Off Characteristic						
V _{(BR)DSS}	Drain-Source Breakdown Voltage	V _{GS} =0V, I _D =250μA	30	-	-	V
I _{DSS}	Zero Gate Voltage Drain Current	V _{DS} =30V, V _{GS} =0V	-	-	1	μA
I _{GSS}	Gate to Body Leakage Current	V _{DS} =0V, V _{GS} =±20V	-	-	±100	nA
On Characteristics						
V _{GS(th)}	Gate Threshold Voltage	V _{DS} =V _{GS} , I _D =250μA	1.0	1.4	2.5	V
R _{DS(on)}	Static Drain-Source on-Resistance <small>note2</small>	V _{GS} =10V, I _D =10A	-	9	12	mΩ
		V _{GS} =4.5V, I _D =5A	-	13.5	19	mΩ
Dynamic Characteristics						
C _{iss}	Input Capacitance	V _{DS} =15V, V _{GS} =0V, f=1.0MHz	-	584	-	pF
C _{oss}	Output Capacitance		-	112	-	pF
C _{rss}	Reverse Transfer Capacitance		-	96	-	pF
Q _g	Total Gate Charge	V _{DS} =15V, I _D =10A, V _{GS} =10V	-	15	-	nC
Q _{gs}	Gate-Source Charge		-	4.7	-	nC
Q _{gd}	Gate-Drain("Miller") Charge		-	3.6	-	nC
Switching Characteristics						
t _{d(on)}	Turn-on Delay Time	V _{DS} =30V, I _D =10A, V _{GS} =10V, R _{REN} =3Ω	-	5	-	ns
t _r	Turn-on Rise Time		-	8	-	ns
t _{d(off)}	Turn-off Delay Time		-	21	-	ns
t _f	Turn-off Fall Time		-	7	-	ns
Drain-Source Diode Characteristics and Maximum Ratings						
I _S	Maximum Continuous Drain to Source Diode Forward Current		-	-	11.5	A
I _{SM}	Maximum Pulsed Drain to Source Diode Forward Current		-	-	46	A
V _{SD}	Drain to Source Diode Forward Voltage	V _{GS} =0V, I _S =11.5A	-	0.8	1.2	V
t _{rr}	Body Diode Reverse Recovery Time	I _F =10A,	-	7	-	ns
Q _{rr}	Body Diode Reverse Recovery	dI/dt=100A/μs	-	5.9	-	nC

Notes:1. Repetitive Rating: Pulse Width Limited by Maximum Junction Temperature

2. EAS condition : T_J=25°C, V_{DD}=15V, V_G=10V, L=0.5mH, R_g=25Ω, I_{AS}=9A

T_J=25°C, V_{DD}= -15V, V_G= -10V, L=0.5mH, R_g=25Ω, I_{AS}= -10A

3. Pulse Test: Pulse Width≤300μs, Duty Cycle≤0.5%



P-Channel Electrical Characteristics (T_J=25°C unless otherwise specified)

Symbol	Parameter	Test Condition	Min.	Typ.	Max.	Units
Off Characteristic						
V _{(BR)DSS}	Drain-Source Breakdown Voltage	V _{GS} =0V, I _D = -250μA	-30	-	-	V
I _{DSS}	Zero Gate Voltage Drain Current	V _{DS} = -30V, V _{GS} =0V,	-	-	-1	μA
I _{GSS}	Gate to Body Leakage Current	V _{DS} =0V, V _{GS} = ±20V	-	-	±100	nA
On Characteristics						
V _{GS(th)}	Gate Threshold Voltage	V _{DS} =V _{GS} , I _D = -250μA	-1.0	-1.5	-2.5	V
R _{DS(on)}	Static Drain-Source on-Resistance <small>note3</small>	V _{GS} = -10V, I _D = -10A	-	18.5	24	mΩ
		V _{GS} = -4.5V, I _D = -5A	-	28	39	
Dynamic Characteristics						
C _{iss}	Input Capacitance	V _{DS} = -15V, V _{GS} =0V, f=1.0MHz	-	1200	-	pF
C _{oss}	Output Capacitance		-	155	-	pF
C _{rss}	Reverse Transfer Capacitance		-	139	-	pF
Q _g	Total Gate Charge	V _{DS} = -15V, I _D = -8A, V _{GS} = -10V	-	52	-	nC
Q _{gs}	Gate-Source Charge		-	9.8	-	nC
Q _{gd}	Gate-Drain("Miller") Charge		-	8.3	-	nC
Switching Characteristics						
t _{d(on)}	Turn-on Delay Time	V _{DD} = -15V, I _D = -1A, V _{GS} = -10V, R _{GEN} =6Ω R _D =15Ω	-	13	-	ns
t _r	Turn-on Rise Time		-	15	-	ns
t _{d(off)}	Turn-off Delay Time		-	198	-	ns
t _f	Turn-off Fall Time		-	98	-	ns
Drain-Source Diode Characteristics and Maximum Ratings						
I _S	Maximum Continuous Drain to Source Diode Forward Current		-	-	-11.5	A
I _{SM}	Maximum Pulsed Drain to Source Diode Forward Current		-	-	-46	A
V _{SD}	Drain to Source Diode Forward Voltage	V _{GS} =0V, I _S = -11.5A	-	-0.8	-1.2	V
trr	Reverse Recovery Time	T _J =25°C,	-	37	-	ns
Qrr	Reverse Recovery Charge	I _F =-2A, dI/dt=-100A/μs	-	36	-	nC



Typical Performance Characteristics-N

Figure 1: Output Characteristics

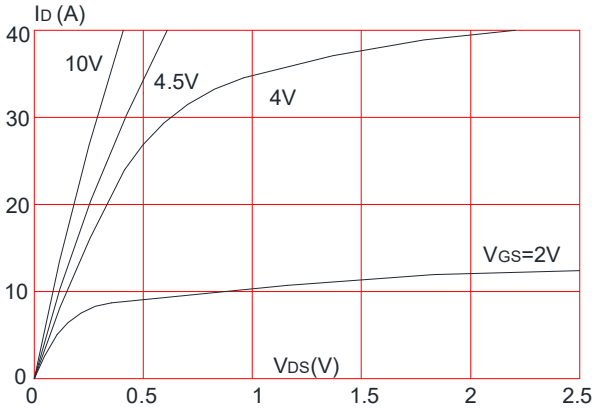

Figure 2: Typical Transfer Characteristics

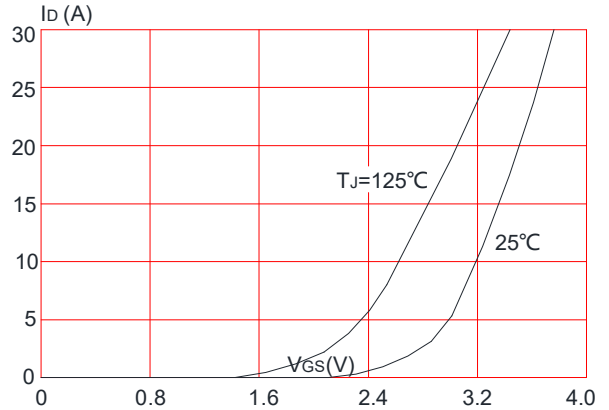

Figure 3: On-resistance vs. Drain Current

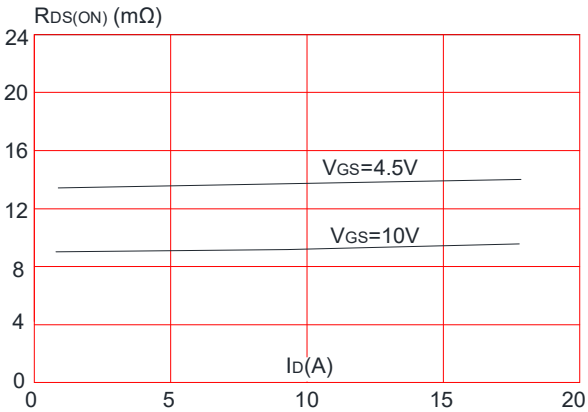

Figure 4: Body Diode Characteristics

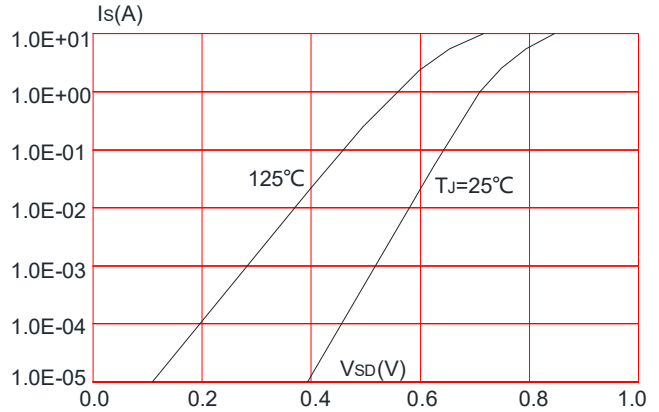

Figure 5: Gate Charge Characteristics

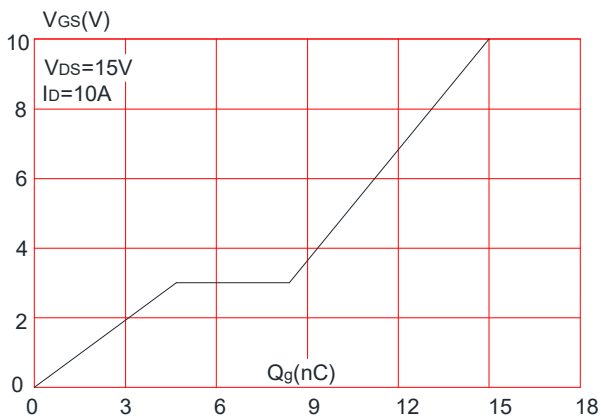

Figure 6: Capacitance Characteristics

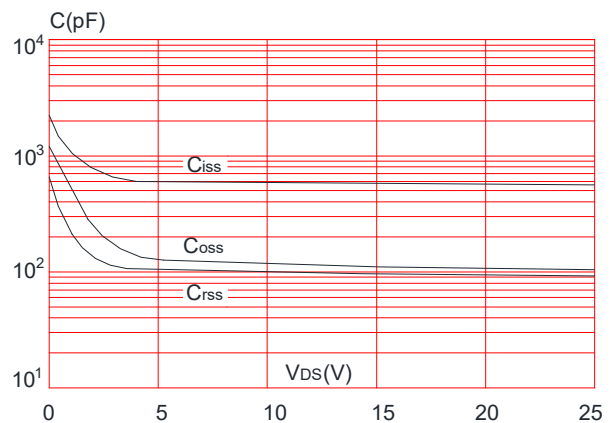



Figure 7: Normalized Breakdown Voltage vs. Junction Temperature

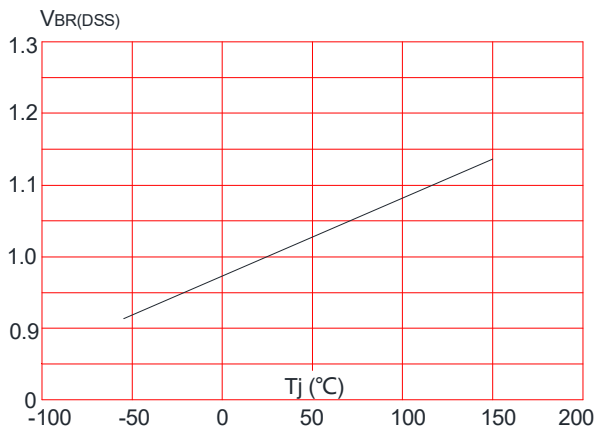

Figure 8: Normalized on Resistance vs. Junction Temperature

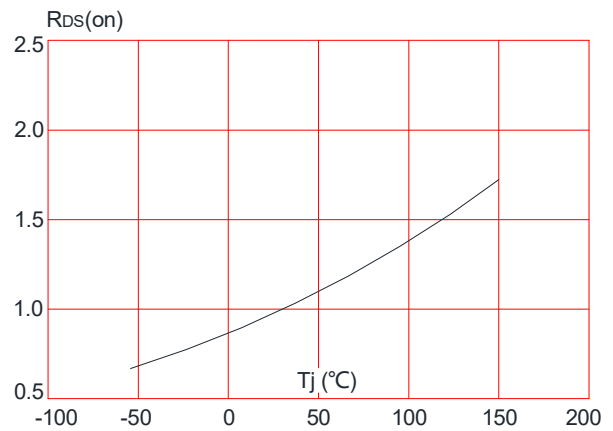

Figure 9: Maximum Safe Operating Area

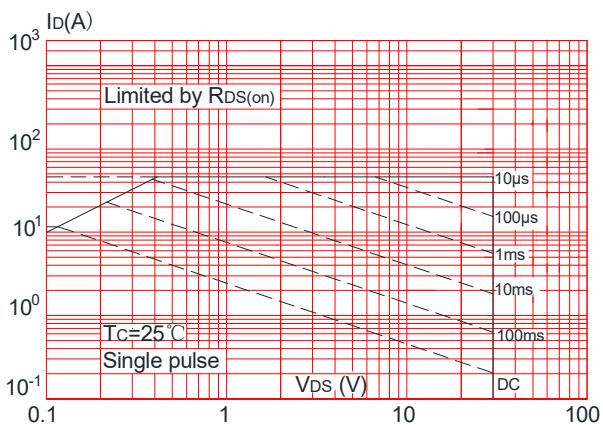

Figure 10: Maximum Continuous Drain Current vs. Case Temperature

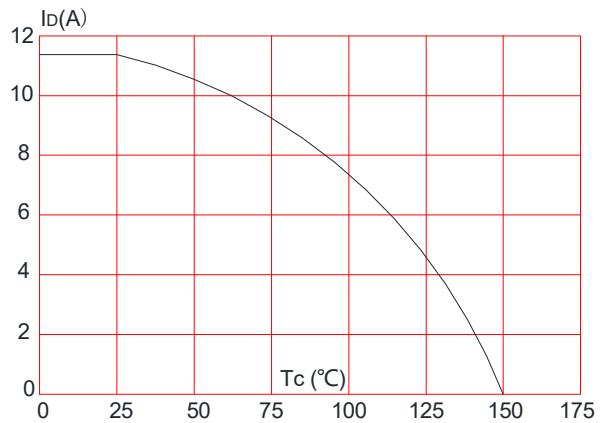
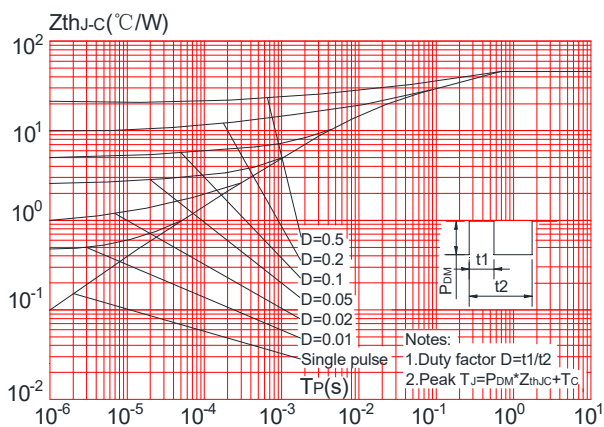

Figure.11: Maximum Effective Transient Thermal Impedance, Junction-to-Case



Test Circuit-N

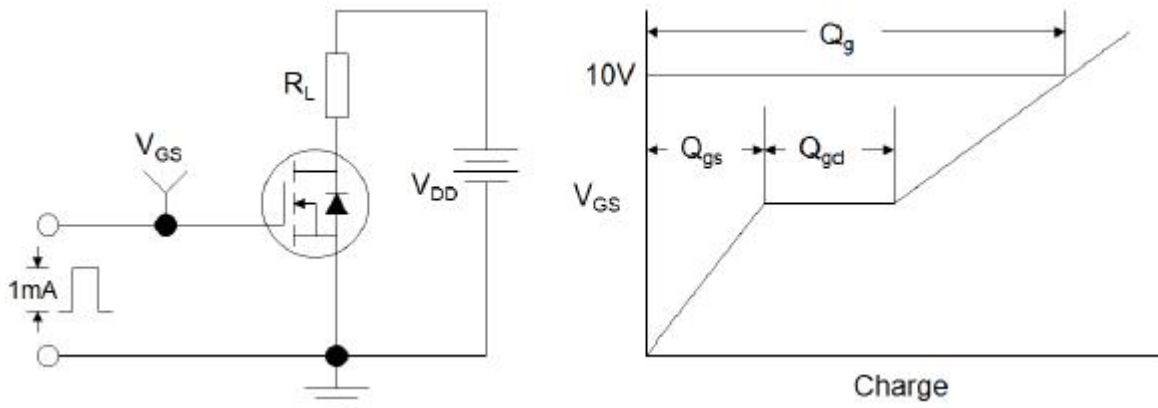

Figure1:Gate Charge Test Circuit & Waveform

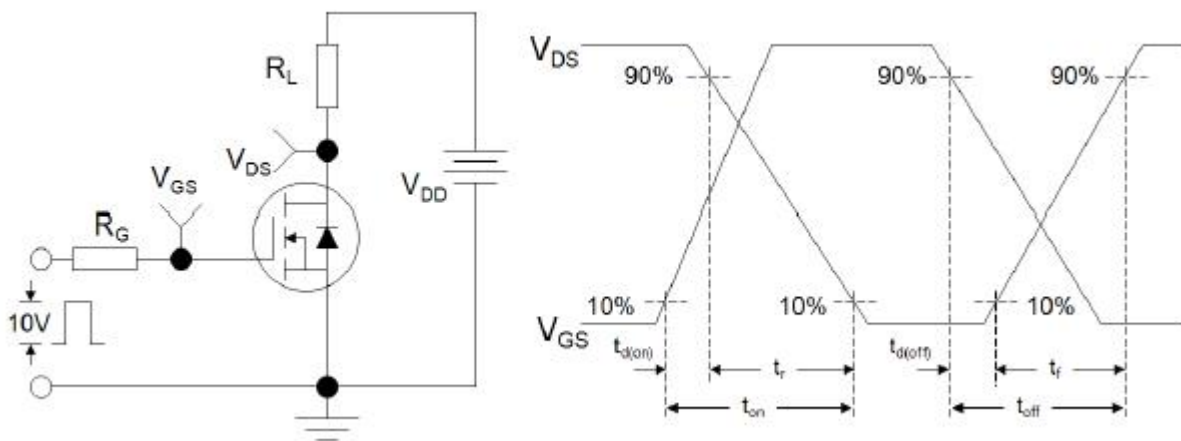

Figure 2: Resistive Switching Test Circuit & Waveforms

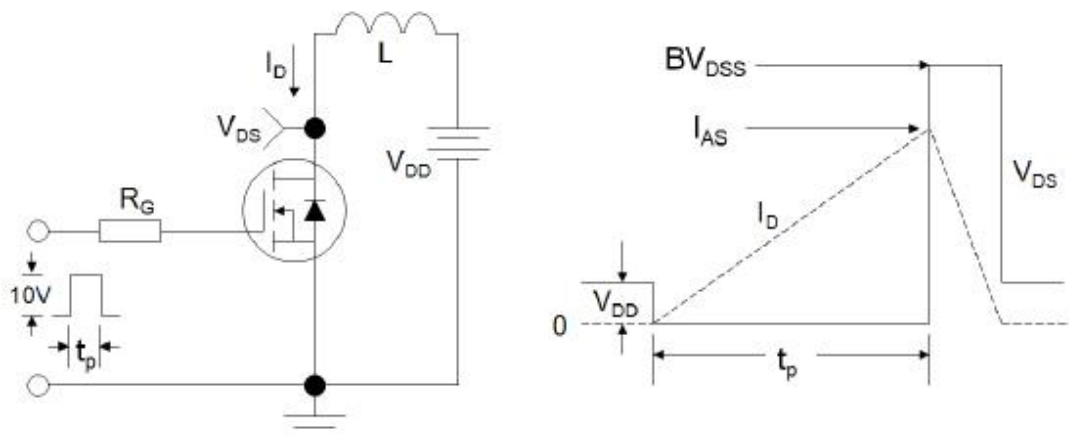

Figure 3:Unclamped Inductive Switching Test Circuit & Waveforms



Typical Performance Characteristics-P

Figure 1: Output Characteristics

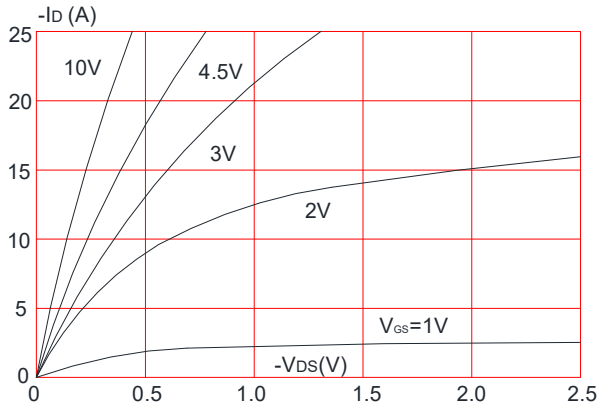

Figure 2: Typical Transfer Characteristics

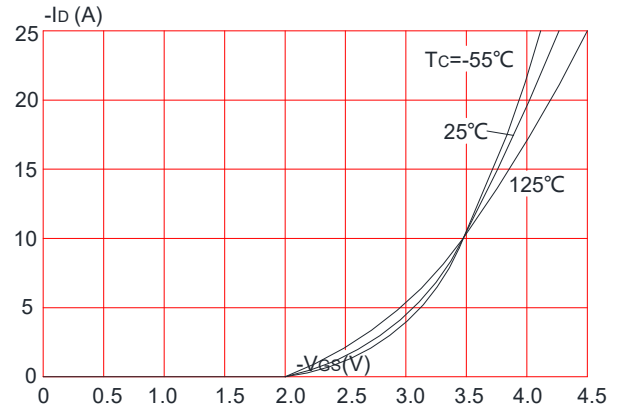

Figure 3: On-resistance vs. Drain Current

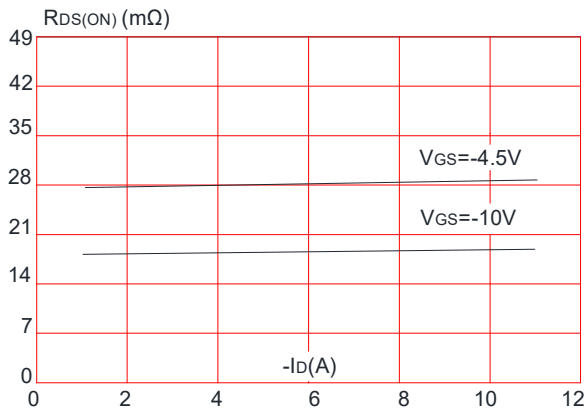

Figure 4: Body Diode Characteristics

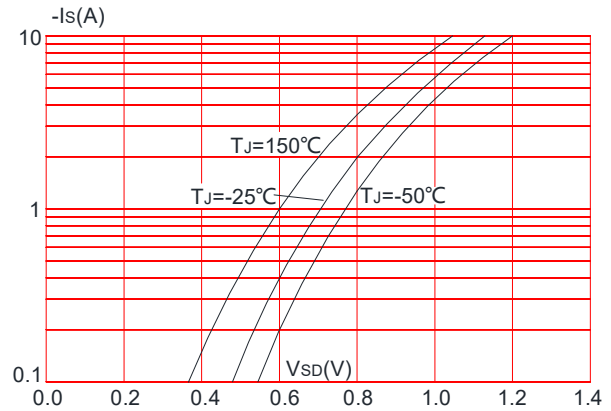

Figure 5: Gate Charge Characteristics

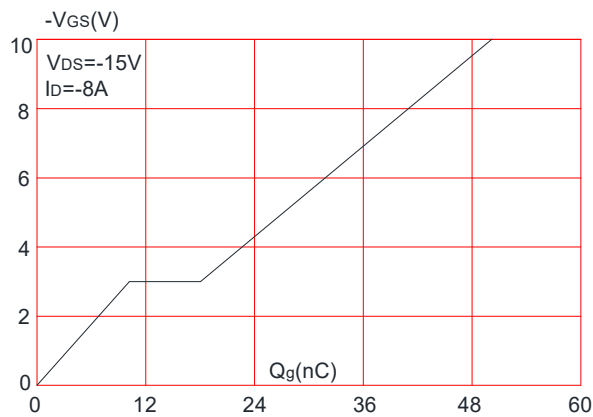

Figure 6: Capacitance Characteristics

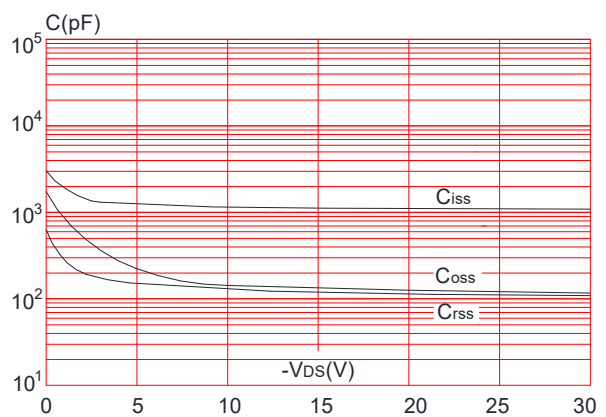



Figure 7: Normalized Breakdown Voltage vs. Junction Temperature

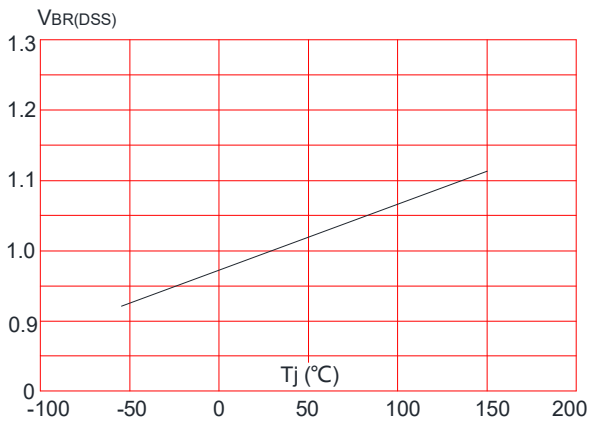

Figure 8: Normalized on Resistance vs. Junction Temperature

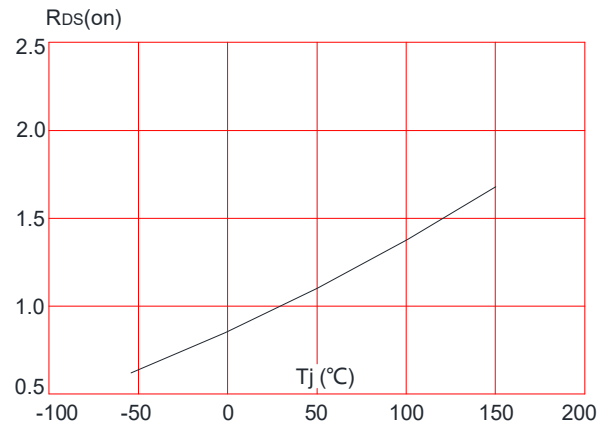

Figure 9: Maximum Safe Operating Area

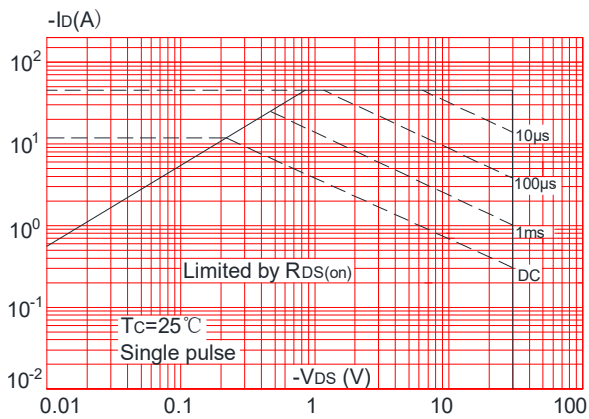

Figure 10: Maximum Continuous Drain Current vs. Case Temperature

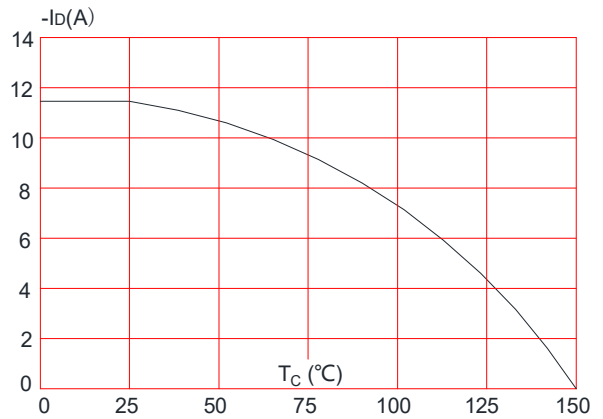
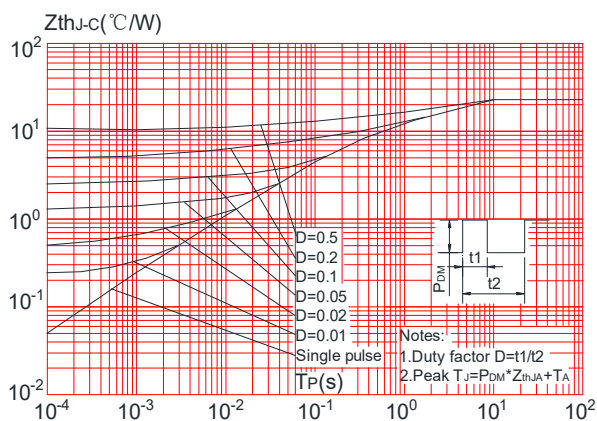
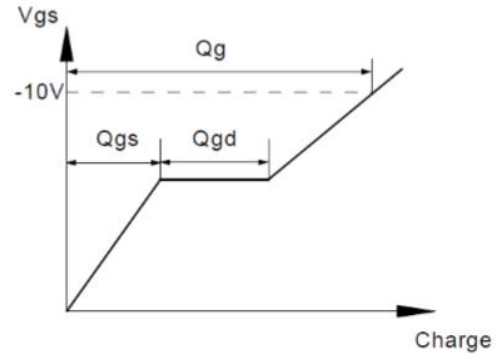
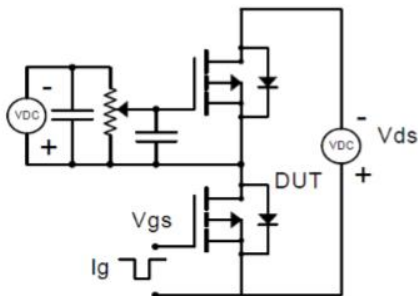

Figure.11: Maximum Effective Transient Thermal Impedance, Junction-to-Ambient



Test Circuit-P

Gate Charge Test Circuit & Waveform



Resistive Switching Test Circuit & Waveforms

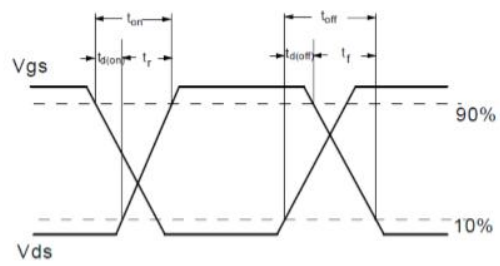
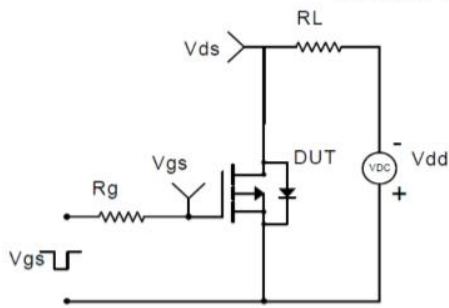

Unclamped Inductive Switching (UIS) Test Circuit & Waveforms

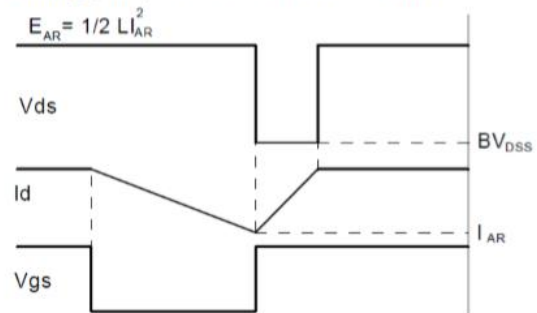
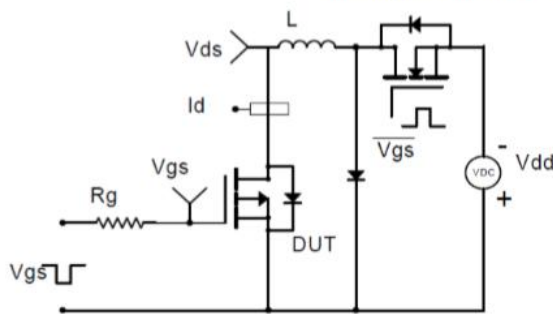

Diode Recovery Test Circuit & Waveforms

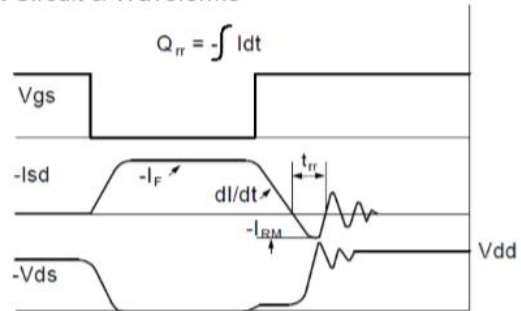
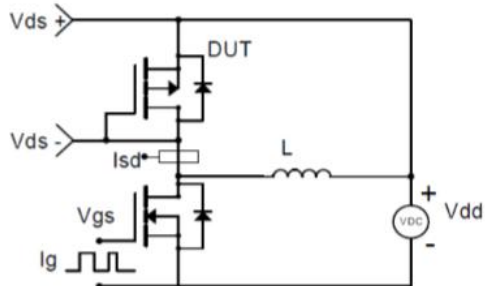



Package Mechanical Data-PDFN5x6-8L-D

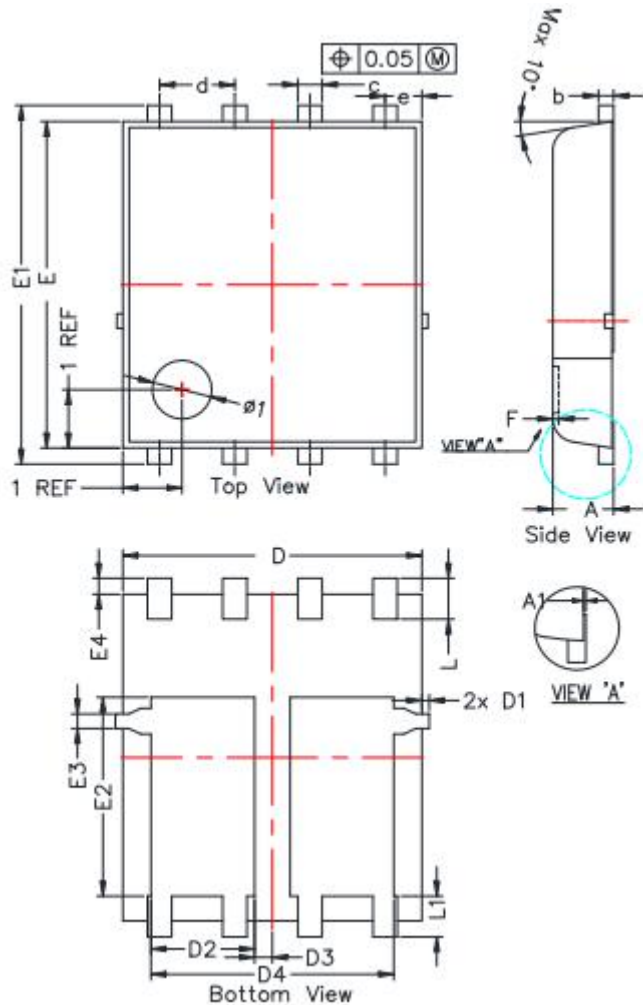

SYMBOLS	DIMENSION IN MM			DIMENSION IN INCHES		
	MIN	NOM	MAX	MIN	NOM	MAX
* A	0.900	1.000	1.100	0.035	0.039	0.043
A1	0.000	---	0.050	0.000	----	0.002
b	0.246	0.254	0.312	0.010	0.010	0.012
* c	0.310	0.410	0.510	0.012	0.016	0.020
d	1.27 BSC			0.050 BSC		
* D	4.950	5.050	5.150	0.195	0.199	0.203
*D1	---	---	0.125	---	---	0.005
*D2	1.650	1.750	1.850	0.065	0.069	0.073
D3	0.200	0.300	0.400	0.008	0.012	0.016
D4	4.000	4.100	4.200	0.157	0.161	0.165
e	0.62 BSC			0.024 BSC		
* E	5.500	5.600	5.700	0.217	0.220	0.224
* E1	6.050	6.150	6.250	0.238	0.242	0.246
E2	3.310	3.410	3.510	0.130	0.134	0.138
E3	0.150	0.250	0.350	0.006	0.010	0.014
* E4	0.175	0.275	0.375	0.007	0.011	0.015
F	-	-	0.100	-	-	0.004
* L	0.500	0.600	0.700	0.02	0.02	0.03
L1	0.600	0.700	0.800	0.02	0.03	0.03

Information furnished in this document is believed to be accurate and reliable. However, Jiangsu JieJie Microelectronics Co.,Ltd assumes no responsibility for the consequences of use without consideration for such information nor use beyond it.

Information mentioned in this document is subject to change without notice, apart from that when an agreement is signed, Jiangsu JieJie complies with the agreement.

Products and information provided in this document have no infringement of patents. Jiangsu JieJie assumes no responsibility for any infringement of other rights of third parties which may result from the use of such products and information.



is a registered trademark of Jiangsu JieJie Microelectronics Co.,Ltd.

Copyright ©2021 Jiangsu JieJie Microelectronics Co.,Ltd. Printed All rights reserved.