



# 100V 7.4mΩ N-Ch Power MOSFET

### Features

- Ultra-low  $R_{DS(ON)}$
- Low Gate Charge
- 100% UIS Tested, 100%  $R_g$  Tested
- Pb-free Lead Plating
- Halogen-free and RoHS-compliant

### Product Summary

Parameter	Typ.	Unit
$V_{DS}$	100	V
$V_{GS(th\_typ)}$	1.8	V
$I_D$ (@ $V_{GS} = 10V$ ) <sup>(1)</sup>	12	A
$R_{DS(ON)}$ (@ $V_{GS} = 10V$ )	7.4	mΩ
$R_{DS(ON)}$ (@ $V_{GS} = 4.5V$ )	9.2	mΩ

### Applications

- Power Management in Telecom., Industrial Automation, CE
- Current Switching in DC/DC & AC/DC (SR) Sub-systems
- Motor Driving in Power Tool, E-vehicle, Robotics

SOP-8L Top View

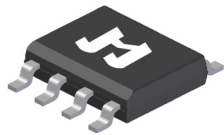

SOP-8L Bottom View

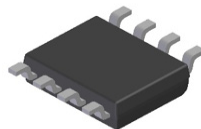

Top View Pin Configuration

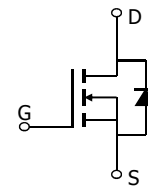
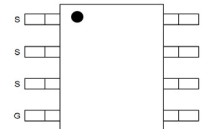

### Ordering Information

Device	Package	# of Pins	Marking	MSL	$T_J$ (°C)	Media	Quantity (pcs)
JMSL1008AP-13	SOP-8L	8	SL1008A	3	-55 to 150	13-inch Reel	4000

### Absolute Maximum Ratings (@ $T_A = 25^\circ C$ unless otherwise specified)

Parameter	Symbol	Value	Unit
Drain-to-Source Voltage	$V_{DS}$	100	V
Gate-to-Source Voltage	$V_{GS}$	±20	V
Continuous Drain Current <sup>(1)</sup>	$I_D$	$T_A = 25^\circ C$	12.1
		$T_A = 70^\circ C$	9.7
Pulsed Drain Current <sup>(2)</sup>	$I_{DM}$	37	A
Avalanche Current <sup>(3)</sup>	$I_{AS}$	45	A
Avalanche Energy <sup>(3)</sup>	$E_{AS}$	101	mJ
Power Dissipation <sup>(4)</sup>	$P_D$	$T_A = 25^\circ C$	2.5
		$T_A = 70^\circ C$	1.6
Junction & Storage Temperature Range	$T_J, T_{STG}$	-55 to 150	°C

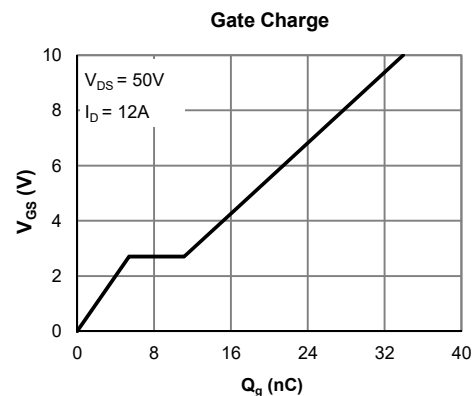
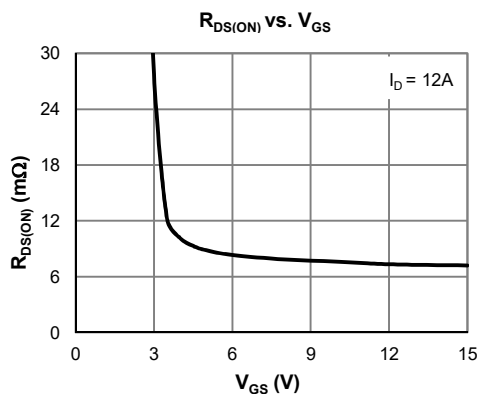



**Electrical Characteristics** (@  $T_J = 25^\circ\text{C}$  unless otherwise specified)

Parameter	Symbol	Conditions	Min.	Typ.	Max.	Unit
<b>STATIC PARAMETERS</b>						
Drain-Source Breakdown Voltage	$V_{(BR)DSS}$	$I_D = 250\mu\text{A}, V_{GS} = 0\text{V}$	100			V
Zero Gate Voltage Drain Current	$I_{DSS}$	$V_{DS} = 80\text{V}, V_{GS} = 0\text{V}$			1.0	$\mu\text{A}$
					5.0	
Gate-Body Leakage Current	$I_{GSS}$	$V_{DS} = 0\text{V}, V_{GS} = \pm 20\text{V}$			$\pm 100$	nA
Gate Threshold Voltage	$V_{GS(th)}$	$V_{DS} = V_{GS}, I_D = 250\mu\text{A}$	1.2	1.8	2.5	V
Static Drain-Source ON-Resistance	$R_{DS(ON)}$	$V_{GS} = 10\text{V}, I_D = 12\text{A}$		7.4	8.9	m $\Omega$
Static Drain-Source ON-Resistance	$R_{DS(ON)}$	$V_{GS} = 4.5\text{V}, I_D = 10\text{A}$		9.2	11.5	m $\Omega$
Forward Transconductance	$g_{FS}$	$V_{DS} = 5\text{V}, I_D = 12\text{A}$		45		S
Diode Forward Voltage	$V_{SD}$	$I_S = 1\text{A}, V_{GS} = 0\text{V}$		0.71	1.0	V
Diode Continuous Current	$I_S$	$T_A = 25^\circ\text{C}$			2.5	A
<b>DYNAMIC PARAMETERS</b> <sup>(5)</sup>						
Input Capacitance	$C_{iss}$	$V_{GS} = 0\text{V}, V_{DS} = 50\text{V}, f = 1\text{MHz}$		2360		pF
Output Capacitance	$C_{oss}$			368		pF
Reverse Transfer Capacitance	$C_{rss}$			5.9		pF
Gate Resistance	$R_g$	$V_{GS} = 0\text{V}, V_{DS} = 0\text{V}, f = 1\text{MHz}$		1.7		$\Omega$
<b>SWITCHING PARAMETERS</b> <sup>(5)</sup>						
Total Gate Charge (@ $V_{GS} = 10\text{V}$ )	$Q_g$	$V_{GS} = 0 \text{ to } 10\text{V}$ $V_{DS} = 50\text{V}, I_D = 12\text{A}$		34		nC
Total Gate Charge (@ $V_{GS} = 4.5\text{V}$ )	$Q_g$			16.8		nC
Gate Source Charge	$Q_{gs}$			5.4		nC
Gate Drain Charge	$Q_{gd}$			5.7		nC
Turn-On Delay Time	$t_{D(on)}$	$V_{GS} = 10\text{V}, V_{DS} = 50\text{V}$ $R_L = 4.1\Omega, R_{GEN} = 6\Omega$		8.4		ns
Turn-On Rise Time	$t_r$			12.2		ns
Turn-Off Delay Time	$t_{D(off)}$			43		ns
Turn-Off Fall Time	$t_f$			18.9		ns
Body Diode Reverse Recovery Time	$t_{rr}$		$I_F = 12\text{A}, dI_F/dt = 100\text{A}/\mu\text{s}$		51	
Body Diode Reverse Recovery Charge	$Q_{rr}$	$I_F = 12\text{A}, dI_F/dt = 100\text{A}/\mu\text{s}$		88		nC

**Thermal Performance**

Parameter	Symbol	Typ.	Max.	Unit
Thermal Resistance, Junction-to-Ambient ( $t \leq 10\text{s}$ )	$R_{\theta JA}$	40	50	$^\circ\text{C}/\text{W}$
Thermal Resistance, Junction-to-Ambient (steady state)		70	85	$^\circ\text{C}/\text{W}$

**Notes:**

1. Computed continuous current assumes the condition of  $T_{J\_Max}$  while the actual continuous current depends on the thermal & electro-mechanical application board design.
2. This single-pulse measurement was taken under  $T_{J\_Max} = 150^\circ\text{C}$ .
3. This single-pulse measurement was taken under the following condition [ $L = 100\mu\text{H}, V_{GS} = 10\text{V}, V_{DS} = 50\text{V}$ ] while its value is limited by  $T_{J\_Max} = 150^\circ\text{C}$ .
4. The power dissipation  $P_D$  is based on  $T_{J\_Max} = 150^\circ\text{C}$ .
5. This value is guaranteed by design hence it is not included in the production test.

Typical Electrical & Thermal Characteristics

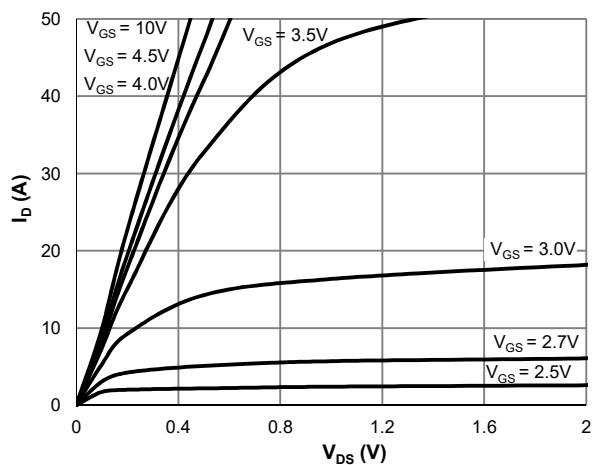

Figure 1: Saturation Characteristics

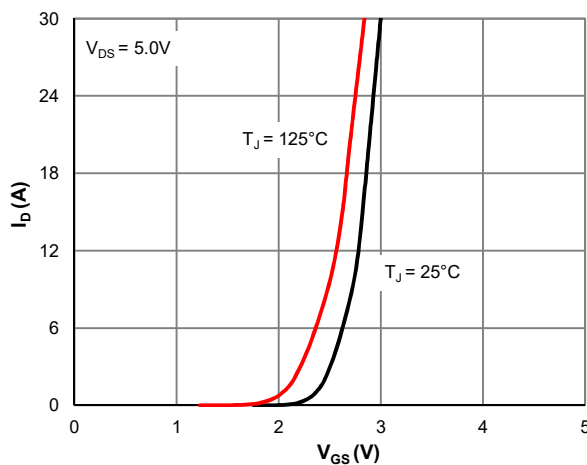

Figure 2: Transfer Characteristics

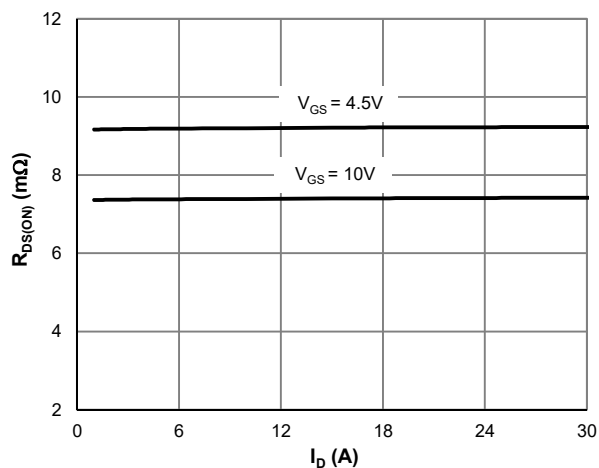

Figure 3:  $R_{DS(ON)}$  vs. Drain Current

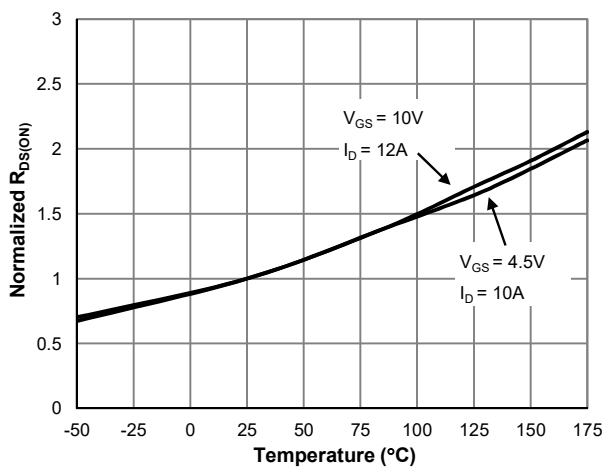

Figure 4:  $R_{DS(ON)}$  vs. Junction Temperature

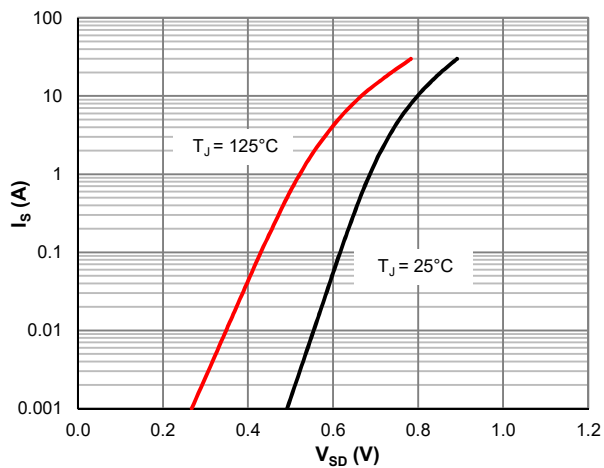

Figure 5: Body-Diode Characteristics

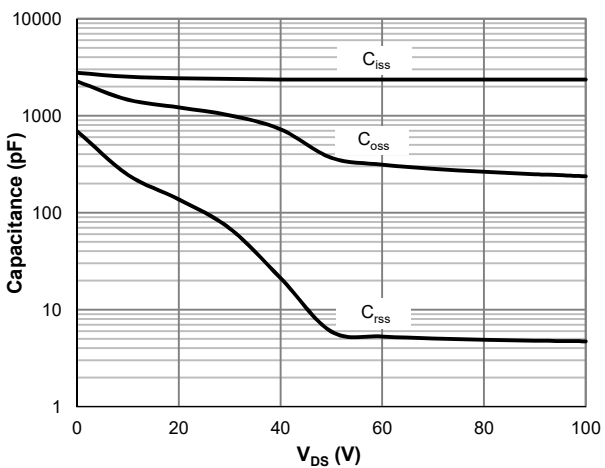

Figure 6: Capacitance Characteristics

Typical Electrical & Thermal Characteristics

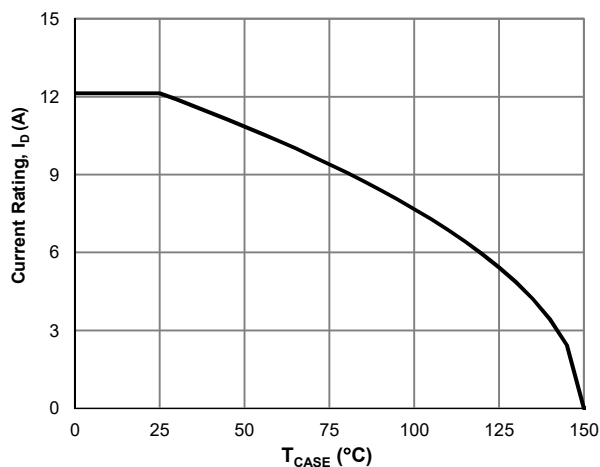

Figure 7: Current De-rating

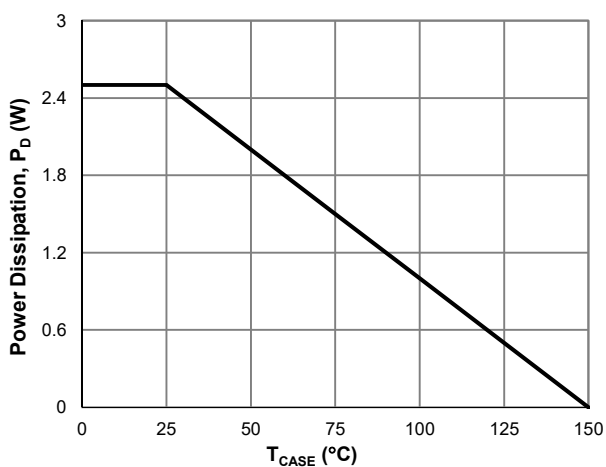

Figure 8: Power De-rating

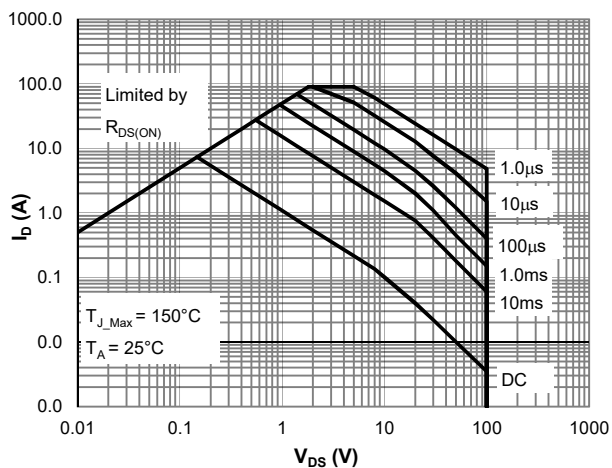

Figure 9: Maximum Safe Operating Area

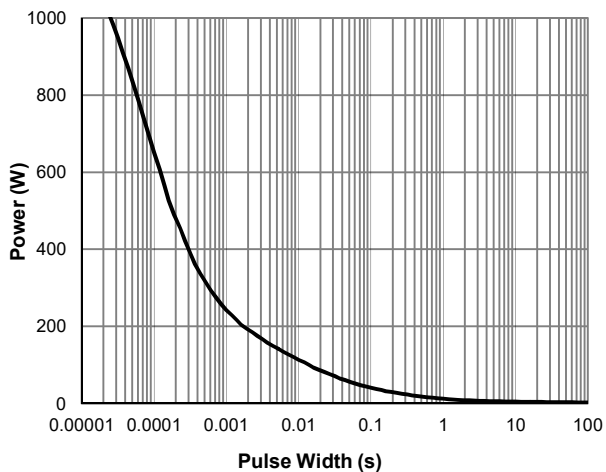

Figure 10: Single Pulse Power Rating, Junction-to-Case

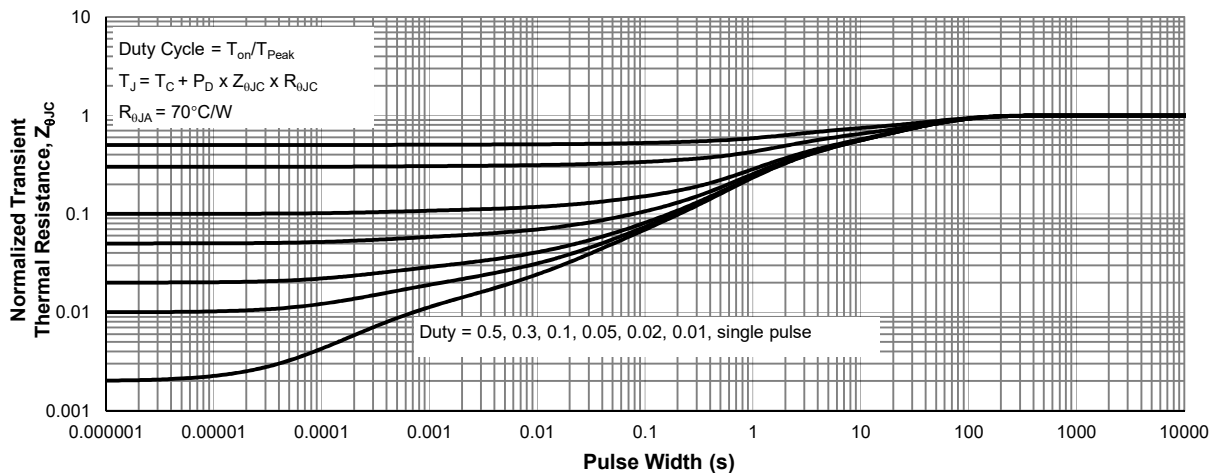
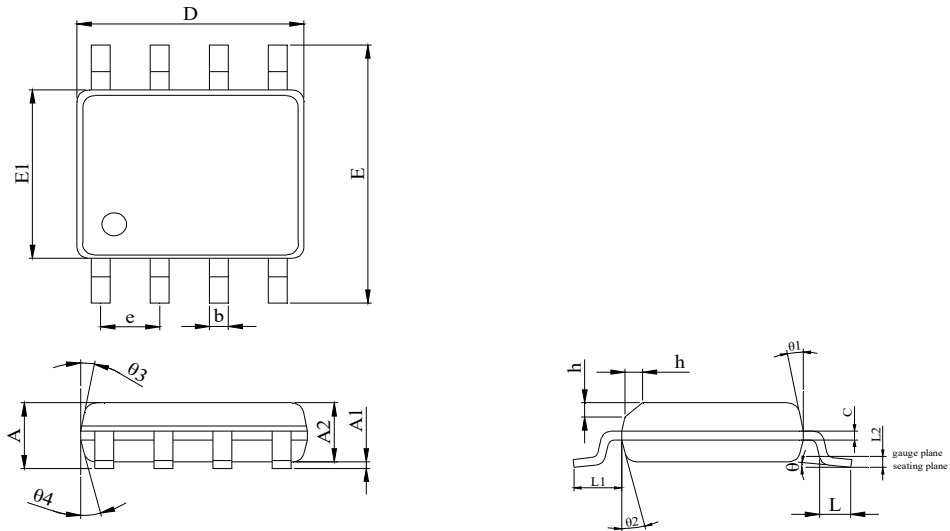
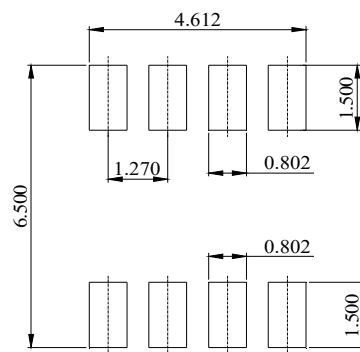

Figure 11: Normalized Maximum Transient Thermal Impedance

**SOP-8L Package Information**
**Package Outline**

DIM	MILLIMETER		
	MIN.	NOM.	MAX.
A	1.35	1.50	1.65
A1	0.05	0.10	0.15
A2	1.35	1.40	1.50
b	0.38	--	0.50
c	0.17	--	0.25
D	4.80	4.90	5.00
E	5.80	6.00	6.20
E1	3.80	3.90	4.00
e	1.27(BSC)		
L	0.45	0.60	0.80
L1	1.04 REF		
L2	0.25 BSC		
h	0.30	0.40	0.50
$\theta$	0°	--	8°
$\theta_1$	10°	12°	14°
$\theta_2$	8°	10°	12°
$\theta_3$	10°	12°	14°
$\theta_4$	8°	10°	12°

**Recommended Footprint**

DIMENSIONS: MILLIMETERS