



150V 10.6mΩ N-Ch Power MOSFET

Features

- Low $R_{DS(ON)}$
- Low Gate Charge
- 100% UIS Tested, 100% R_g Tested
- Pb-free Lead Plating
- Halogen-free and RoHS-compliant

Product Summary

| Parameter | Value | Unit |
|--|-------|------|
| V_{DS} | 150 | V |
| $V_{GS(th_Typ)}$ | 3.2 | V |
| I_D (@ $V_{GS} = 10V$) ⁽¹⁾ | 69 | A |
| $R_{DS(ON_Typ)}$ (@ $V_{GS} = 10V$) | 10.6 | mΩ |

Applications

- Power Management in Telecom., Industrial Automation, CE
- Current Switching in DC/DC & AC/DC (SR) Sub-systems
- Motor Driving in Power Tool, E-vehicle, Robotics

TO-220-3L Top View

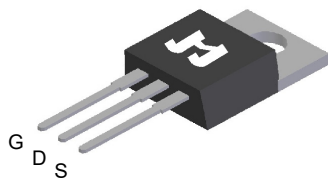

TO-263-3L Top View

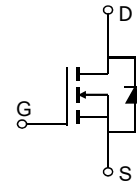
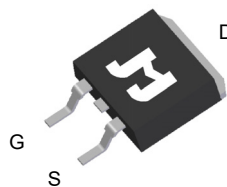

Ordering Information

| Device | Package | # of Pins | Marking | MSL | T_J (°C) | Media | Quantity (pcs) |
|---------------|-----------|-----------|---------|-----|------------|--------------|----------------|
| JMSH1513AC-U | TO-220-3L | 3 | SH1513A | N/A | -55 to 150 | Tube | 50 |
| JMSH1513AE-13 | TO-263-3L | 3 | SH1513A | 1 | -55 to 150 | 13-inch Reel | 800 |

Absolute Maximum Ratings (@ $T_A = 25^\circ C$ unless otherwise specified)

| Parameter | Symbol | Value | Unit |
|---|----------------|---------------------|------|
| Drain-to-Source Voltage | V_{DS} | 150 | V |
| Gate-to-Source Voltage | V_{GS} | ±20 | V |
| Continuous Drain Current ⁽¹⁾ | I_D | $T_C = 25^\circ C$ | 69 |
| | | $T_C = 100^\circ C$ | 43 |
| Pulsed Drain Current ⁽²⁾ | I_{DM} | 232 | A |
| Avalanche Current ⁽³⁾ | I_{AS} | 34 | A |
| Avalanche Energy ⁽³⁾ | E_{AS} | 173 | mJ |
| Power Dissipation ⁽⁴⁾ | P_D | $T_C = 25^\circ C$ | 139 |
| | | $T_C = 100^\circ C$ | 56 |
| Junction & Storage Temperature Range | T_J, T_{STG} | -55 to 150 | °C |

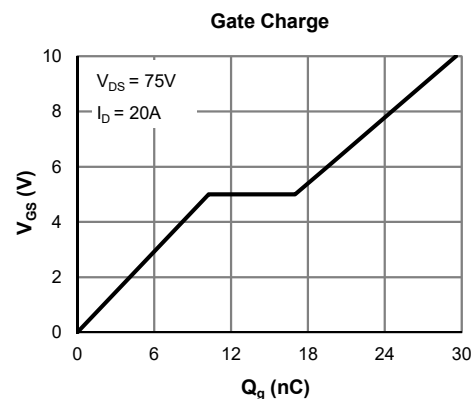
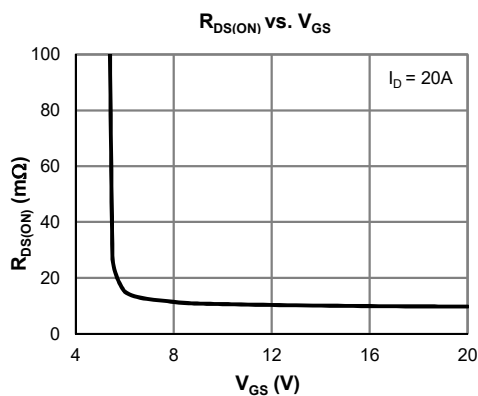



Electrical Characteristics (@ $T_J = 25^\circ\text{C}$ unless otherwise specified)

| Parameter | Symbol | Conditions | Min. | Typ. | Max. | Unit | |
|---|---------------|---|---|------|-----------|---------------|------------|
| STATIC PARAMETERS | | | | | | | |
| Drain-Source Breakdown Voltage | $V_{(BR)DSS}$ | $I_D = 250\mu\text{A}, V_{GS} = 0\text{V}$ | 150 | | | V | |
| Zero Gate Voltage Drain Current | I_{DSS} | $V_{DS} = 120\text{V}, V_{GS} = 0\text{V}$ | | | 1.0 | μA | |
| | | | | | 5.0 | | |
| Gate-Body Leakage Current | I_{GSS} | $V_{DS} = 0\text{V}, V_{GS} = \pm 20\text{V}$ | | | ± 100 | nA | |
| Gate Threshold Voltage | $V_{GS(th)}$ | $V_{DS} = V_{GS}, I_D = 250\mu\text{A}$ | 2.5 | 3.2 | 4.5 | V | |
| Static Drain-Source ON-Resistance | $R_{DS(on)}$ | $V_{GS} = 10\text{V}, I_D = 20\text{A}$ | TO-263-3L | | 10.6 | 13.3 | m Ω |
| | | | TO-220-3L | | 10.8 | 13.7 | m Ω |
| Forward Transconductance | g_{FS} | $V_{DS} = 5\text{V}, I_D = 20\text{A}$ | | 48 | | S | |
| Diode Forward Voltage | V_{SD} | $I_S = 1\text{A}, V_{GS} = 0\text{V}$ | | 0.71 | 1.0 | V | |
| Diode Continuous Current | I_S | $T_C = 25^\circ\text{C}$ | | | 139 | A | |
| DYNAMIC PARAMETERS ⁽⁵⁾ | | | | | | | |
| Input Capacitance | C_{iss} | $V_{GS} = 0\text{V}, V_{DS} = 75\text{V}, f = 1\text{MHz}$ | | 2128 | | pF | |
| Output Capacitance | C_{oss} | | | 274 | | pF | |
| Reverse Transfer Capacitance | C_{rss} | | | 9.0 | | pF | |
| Gate Resistance | R_g | $V_{GS} = 0\text{V}, V_{DS} = 0\text{V}, f = 1\text{MHz}$ | | 1.9 | | Ω | |
| SWITCHING PARAMETERS ⁽⁵⁾ | | | | | | | |
| Total Gate Charge (@ $V_{GS} = 10\text{V}$) | Q_g | $V_{GS} = 0 \text{ to } 10\text{V}$ $V_{DS} = 75\text{V}, I_D = 20\text{A}$ | | 30 | | nC | |
| Total Gate Charge (@ $V_{GS} = 6.0\text{V}$) | Q_g | | | 19.5 | | nC | |
| Gate Source Charge | Q_{gs} | | | 10.3 | | nC | |
| Gate Drain Charge | Q_{gd} | | | 6.8 | | nC | |
| Turn-On Delay Time | $t_{D(on)}$ | $V_{GS} = 10\text{V}, V_{DS} = 75\text{V}$ $R_L = 3.75\Omega, R_{GEN} = 6\Omega$ | | 22 | | ns | |
| Turn-On Rise Time | t_r | | | 58 | | ns | |
| Turn-Off Delay Time | $t_{D(off)}$ | | | 33 | | ns | |
| Turn-Off Fall Time | t_f | | | 20 | | ns | |
| Body Diode Reverse Recovery Time | t_{rr} | | $I_F = 15\text{A}, dI_F/dt = 100\text{A}/\mu\text{S}$ | | 86 | | ns |
| Body Diode Reverse Recovery Charge | Q_{rr} | $I_F = 15\text{A}, dI_F/dt = 100\text{A}/\mu\text{S}$ | | 161 | | nC | |

Thermal Performance

| Parameter | Symbol | Typ. | Max. | Unit |
|---|-----------------|------|------|---------------------------|
| Thermal Resistance, Junction-to-Ambient | $R_{\theta JA}$ | 50 | 60 | $^\circ\text{C}/\text{W}$ |
| Thermal Resistance, Junction-to-Case | $R_{\theta JC}$ | 0.70 | 0.90 | $^\circ\text{C}/\text{W}$ |

Notes:

1. Computed continuous current assumes the condition of T_{J_Max} while the actual continuous current depends on the thermal & electro-mechanical application board design.
2. This single-pulse measurement was taken under $T_{J_Max} = 150^\circ\text{C}$.
3. This single-pulse measurement was taken under the following condition [L = 300 μH , $V_{GS} = 10\text{V}$, $V_{DS} = 75\text{V}$] while its value is limited by $T_{J_Max} = 150^\circ\text{C}$.
4. The power dissipation P_D is based on $T_{J_Max} = 150^\circ\text{C}$.
5. This value is guaranteed by design hence it is not included in the production test.

Typical Electrical & Thermal Characteristics

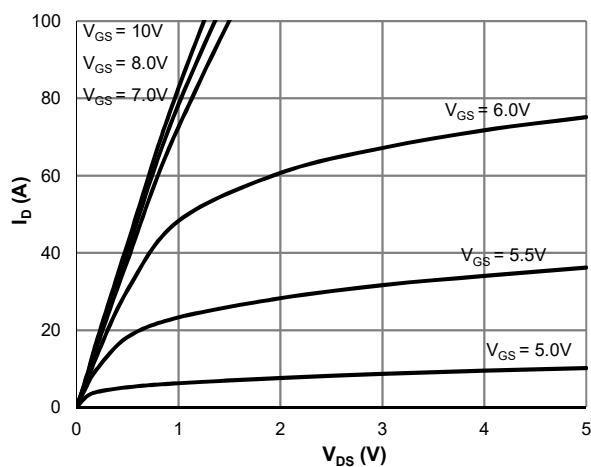

Figure 1: Saturation Characteristics

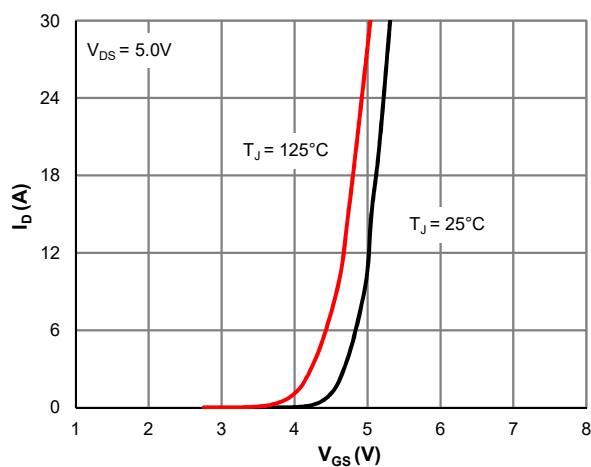

Figure 2: Transfer Characteristics

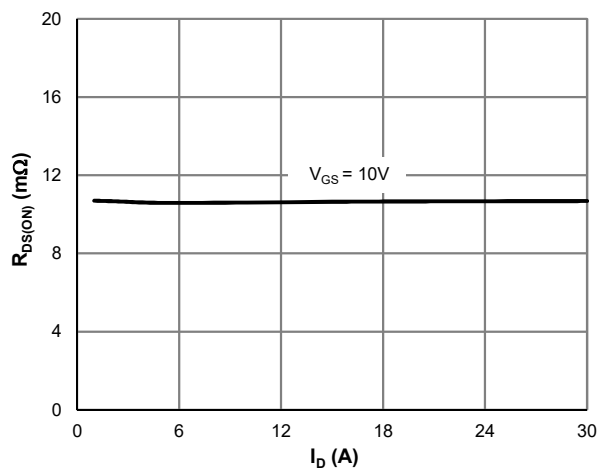

Figure 3: $R_{DS(ON)}$ vs. Drain Current

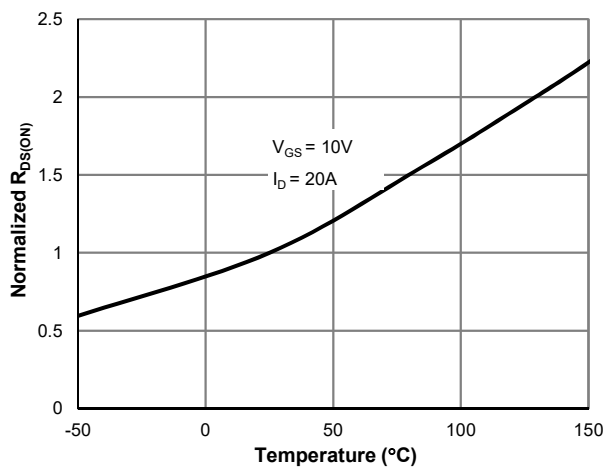

Figure 4: $R_{DS(ON)}$ vs. Junction Temperature

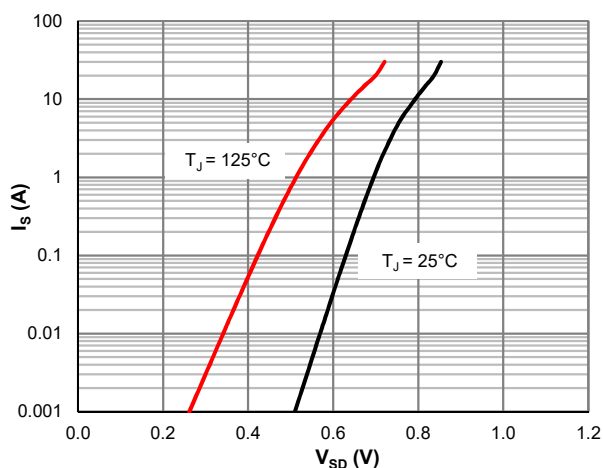

Figure 5: Body-Diode Characteristics

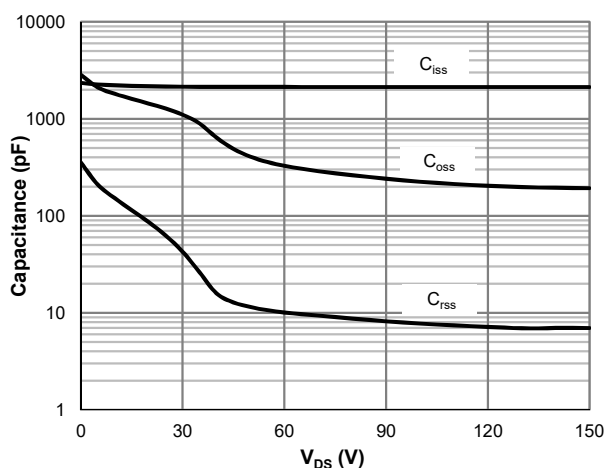

Figure 6: Capacitance Characteristics

Typical Electrical & Thermal Characteristics

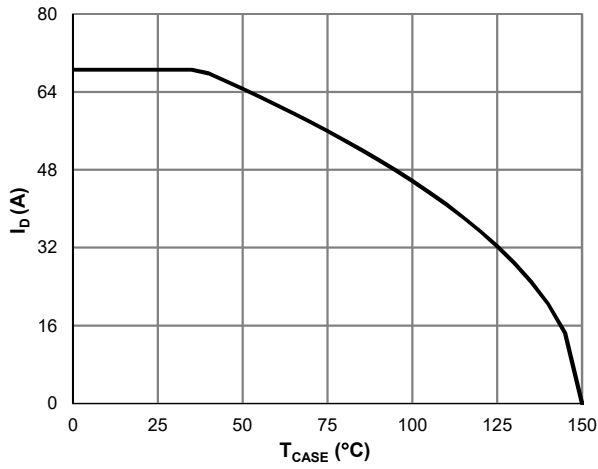

Figure 7: Current De-rating

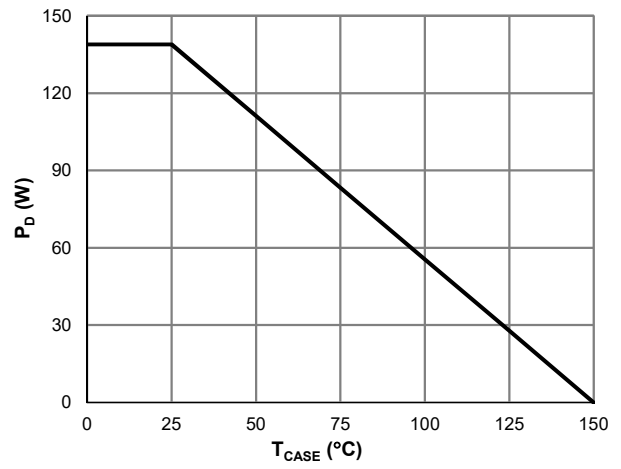

Figure 8: Power De-rating

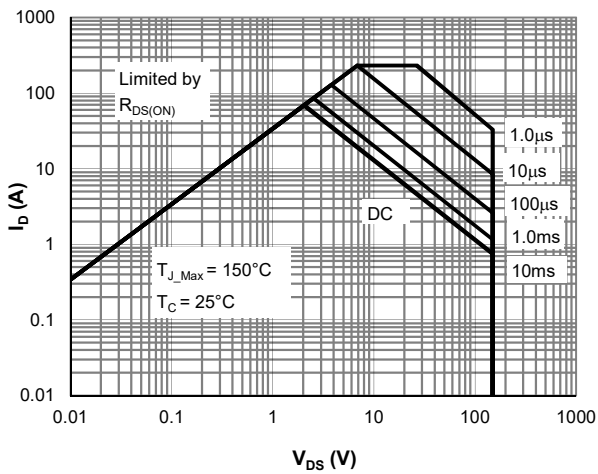

Figure 9: Maximum Safe Operating Area

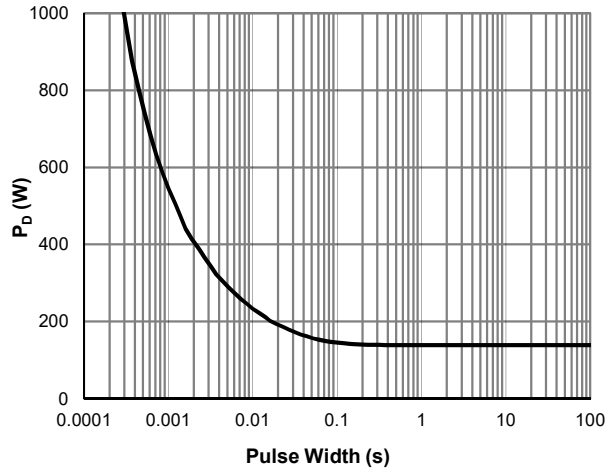

Figure 10: Single Pulse Power Rating, Junction-to-Case

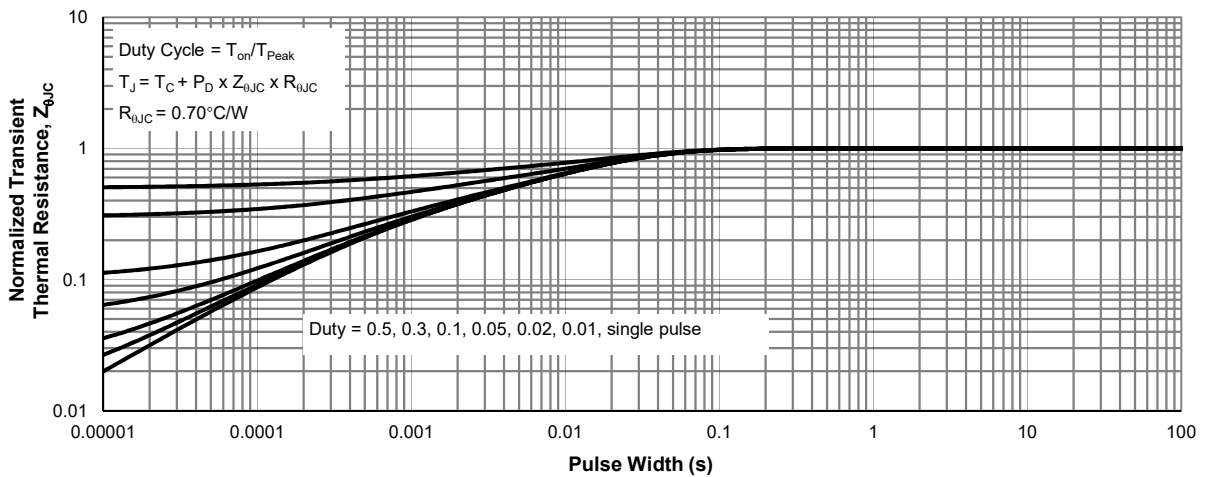
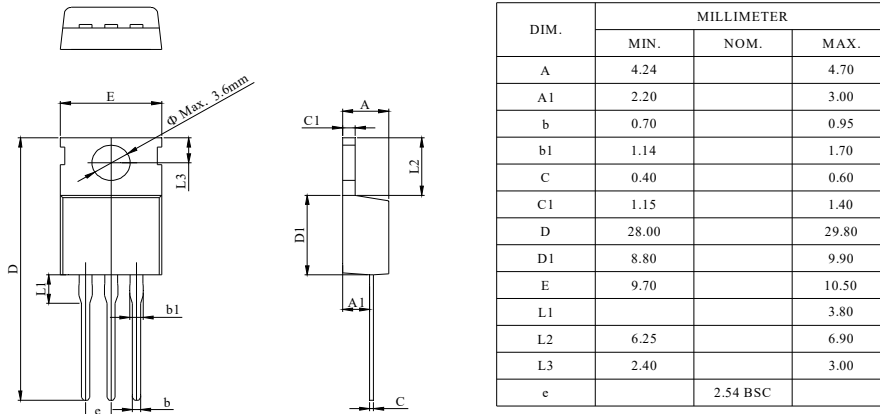

Figure 11: Normalized Maximum Transient Thermal Impedance

TO-220-3L Package Information

Package Outline



TO-263-3L Package Information

Package Outline

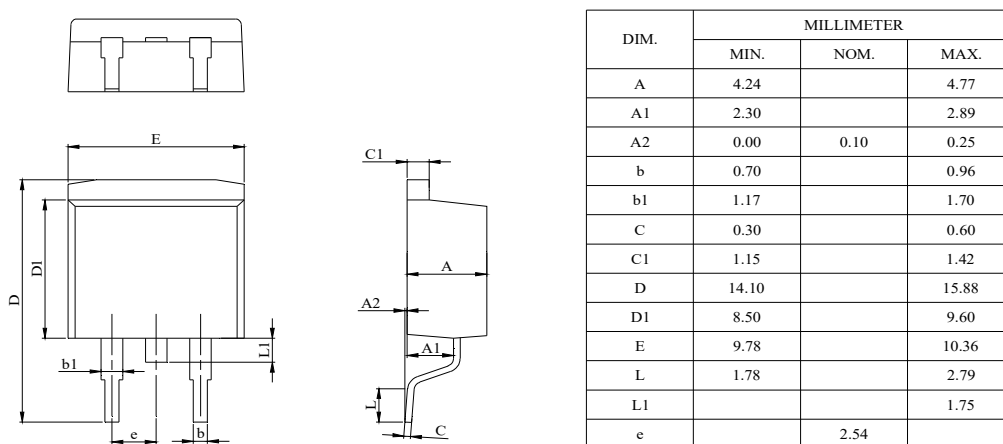

Recommended Footprint

