

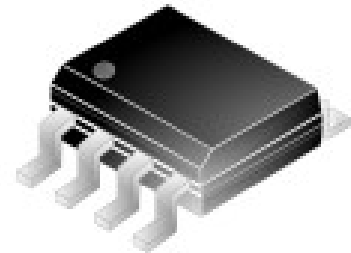

FEATURES

- ◇ 500 Watts peak pulse power per line ($t_p=8/20\mu s$)
- ◇ Protects four I/O lines and power supply line
- ◇ Low capacitance ($<15pF$) for high-speed interfaces
- ◇ Low clamping voltage
- ◇ Low operating voltage
- ◇ Solid-state technology
- ◇ RoHS compliant



SOP-8

MAIN APPLICATIONS

- ◇ USB power & data line protection
- ◇ HDSL, IDSL secondary IC side protection
- ◇ Video line protection
- ◇ Microcontroller input protection
- ◇ I²C bus protection
- ◇ Base stations

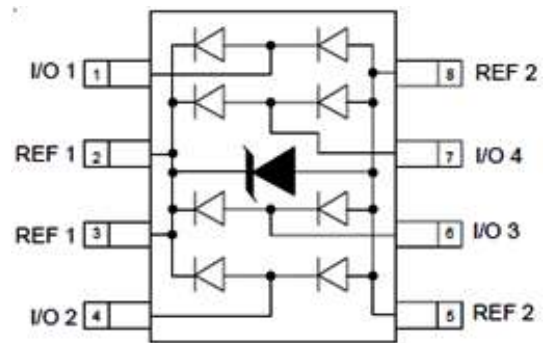

Pin configuration

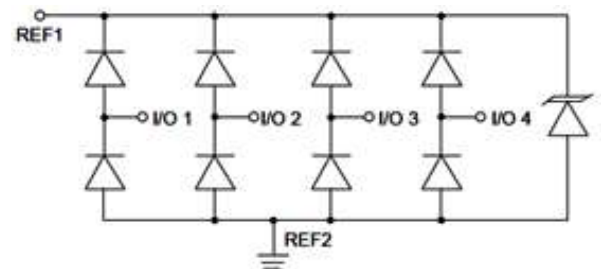

Circuit diagram

PROTECTION SOLUTION TO MEET

- ◇ IEC61000-4-2 (ESD) $\pm 15kV$ (air), $\pm 8kV$ (contact)
- ◇ IEC61000-4-4 (EFT) 40A (5/50ns)
- ◇ IEC61000-4-5 (Lightning) 25A (8/20 μs)

MECHANICAL CHARACTERISTICS

- ◇ JEDEC SOP-8 package
- ◇ Molding compound flammability rating : UL 94V-0
- ◇ Quantity per reel : 4,000pcs
- ◇ Lead finish : lead free
- ◇ Marking code : 05-4RDAXX

ABSOLUTE MAXIMUM RATINGS ($T_A=25^{\circ}\text{C}$, RH=45%-75%, unless otherwise noted)

| Parameter | Symbol | Value | Unit |
|--|-----------|-----------------|--------------------|
| Peak pulse power dissipation at 8/20 μs waveform | P_{PP} | 500 | W |
| ESD per IEC 61000-4-2 (Air) ESD per IEC 61000-4-2 (Contact) | V_{ESD} | +/- 15 +/- 8 | kV |
| Lead soldering temperature | T_L | 260 (10 sec.) | $^{\circ}\text{C}$ |
| Operating junction temperature range | T_J | -55 to +125 | $^{\circ}\text{C}$ |
| Storage temperature range | T_{STG} | -55 to +150 | $^{\circ}\text{C}$ |

ELECTRICAL CHARACTERISTICS ($T_A=25^{\circ}\text{C}$)

| Parameter | Symbol | Conditions | Min | Typ | Max | Unit |
|---------------------------|-----------|--|-----|-----|-----|---------------|
| Reverse working voltage | V_{RWM} | | | | 5 | V |
| Reverse breakdown voltage | V_{BR} | $I_T=1\text{mA}$ | 6 | | | V |
| Reverse leakage current | I_R | $V_{RWM}=5\text{V}$ | | | 10 | μA |
| Clamping voltage | V_C | $I_{PP}=1\text{A}, t_p=8/20\mu\text{s}$ | | | 9.8 | V |
| | | $I_{PP}=10\text{A}, t_p=8/20\mu\text{s}$ | | | 12 | V |
| | | $I_{PP}=25\text{A}, t_p=8/20\mu\text{s}$ | | | 20 | V |
| Junction capacitance | C_J | Between I/O pins and GND $V_R=0\text{V}, f=1\text{MHz}$ | | 8 | 15 | pF |
| | | Between I/O pins $V_R=0\text{V}, f=1\text{MHz}$ | | 4 | | pF |

RATINGS AND V-I CHARACTERISTICS CURVES ($T_A=25^{\circ}\text{C}$, unless otherwise noted)

FIG.1: V- I curve characteristics (Uni-directional)

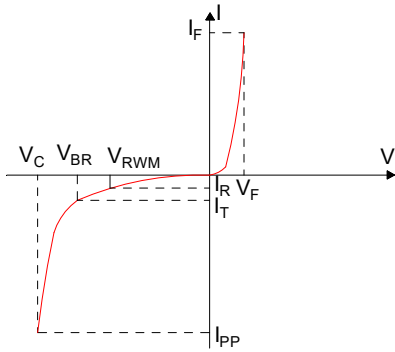

FIG.2: Pulse waveform (8/20 μs)

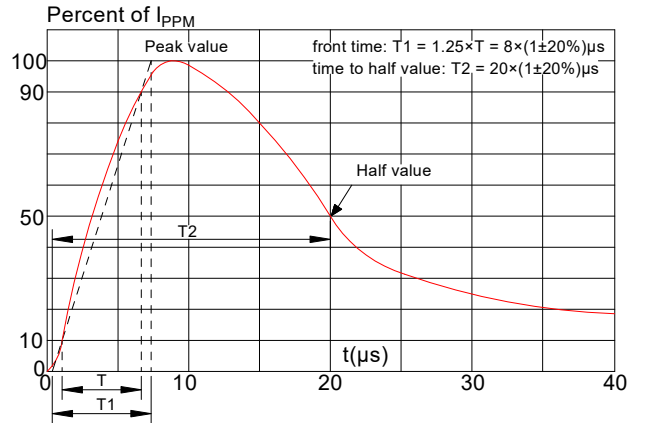

FIG.3: Pulse derating curve

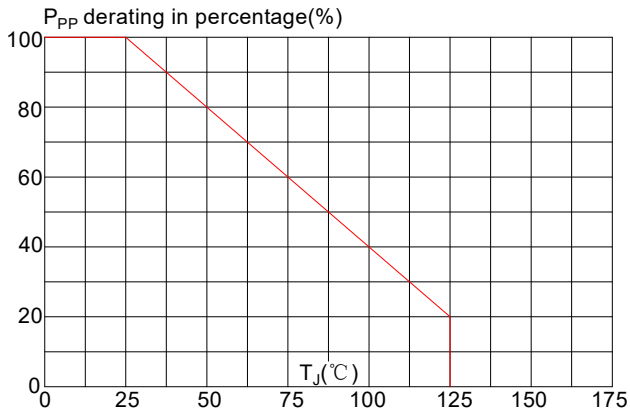
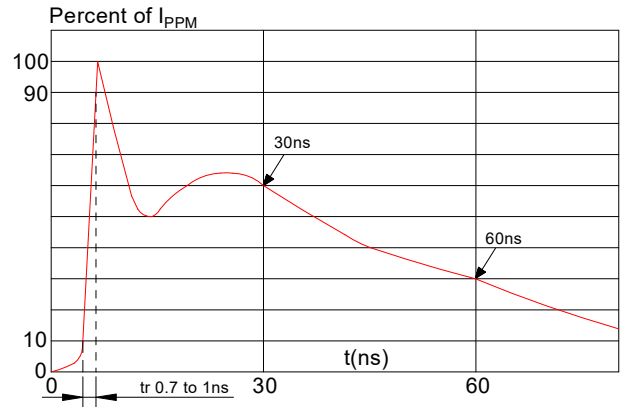
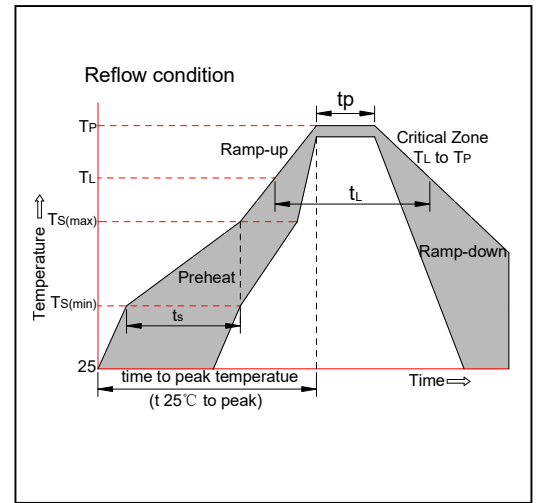

FIG.4: ESD clamping (8kV contact)



SOLDERING PARAMETERS

| | | |
|---|-----------------------------------|---|
| Reflow Condition | | Pb-Free assembly (see figure at right) |
| Pre Heat | -Temperature Min ($T_{s(min)}$) | +150°C |
| | -Temperature Max($T_{s(max)}$) | +200°C |
| | -Time (Min to Max) (t_s) | 60-180 secs. |
| Average ramp up rate (Liquidus Temp (T_L)to peak) | | 3°C/sec. Max |
| $T_{s(max)}$ to T_L - Ramp-up Rate | | 3°C/sec. Max |
| Reflow | -Temperature(T_L)(Liquidus) | +217°C |
| | -Temperature(t_L) | 60-150 secs. |
| Peak Temp (T_p) | | +260(+0/-5)°C |
| Time within 5°C of actual Peak Temp (t_p) | | 20-40secs. |
| Ramp-down Rate | | 6°C/sec. Max |
| Time 25°C to Peak Temp (T_p) | | 8 min. Max |
| Do not exceed | | +260°C |



PACKAGE MECHANICAL DATA

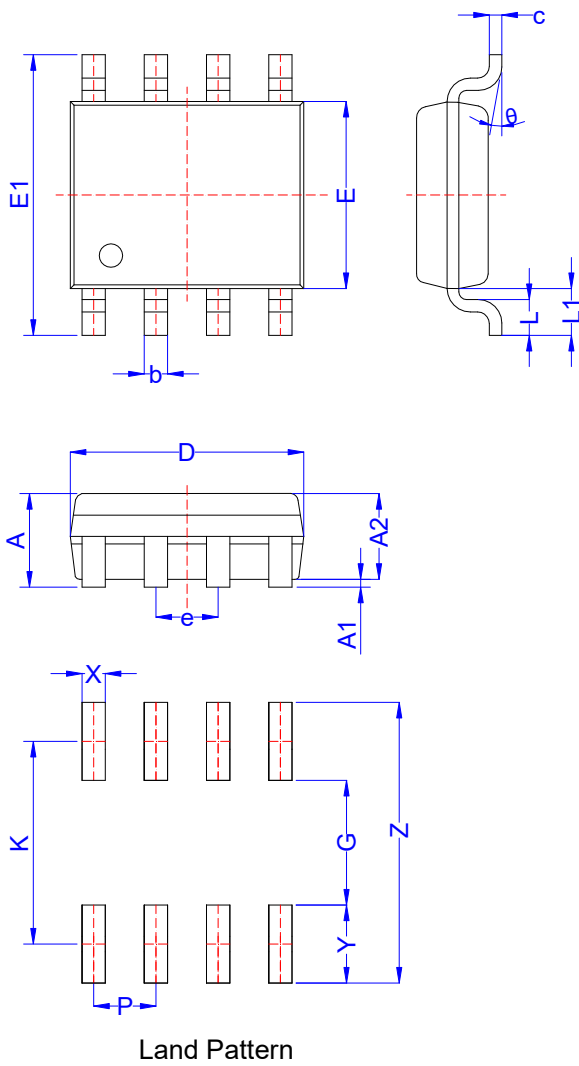

| Symbol | Millimeter | | | Inches | | |
|--------|------------|-------|-------|--------|-------|-------|
| | Min | Typ | Max | Min | Typ | Max |
| A | 1.35 | 1.55 | 1.70 | 0.053 | 0.061 | 0.067 |
| A1 | 0.04 | 0.11 | 0.18 | 0.002 | 0.004 | 0.007 |
| A2 | 1.30 | 1.40 | 1.55 | 0.051 | 0.055 | 0.061 |
| b | 0.31 | 0.41 | 0.51 | 0.012 | 0.016 | 0.020 |
| c | 0.17 | 0.21 | 0.25 | 0.007 | 0.008 | 0.010 |
| D | 4.65 | 4.90 | 5.10 | 0.183 | 0.193 | 0.201 |
| E | 3.70 | 3.90 | 4.10 | 0.146 | 0.154 | 0.161 |
| E1 | 5.80 | 6.00 | 6.20 | 0.228 | 0.236 | 0.244 |
| e | 1.14 | 1.27 | 1.40 | 0.045 | 0.050 | 0.055 |
| L | 0.40 | 0.50 | 0.77 | 0.016 | 0.020 | 0.030 |
| L1 | 0.825 | 1.025 | 1.225 | 0.032 | 0.040 | 0.048 |
| θ | 0° | 4° | 8° | 0° | 4° | 8° |
| G | 3.00 | | | 0.118 | | |
| K | 5.20 | | | 0.205 | | |
| P | 1.27 | | | 0.050 | | |
| X | 0.60 | | | 0.024 | | |
| Y | 2.20 | | | 0.087 | | |
| Z | 7.40 | | | 0.291 | | |

TAPE AND REEL SPECIFICATION-SOP-8

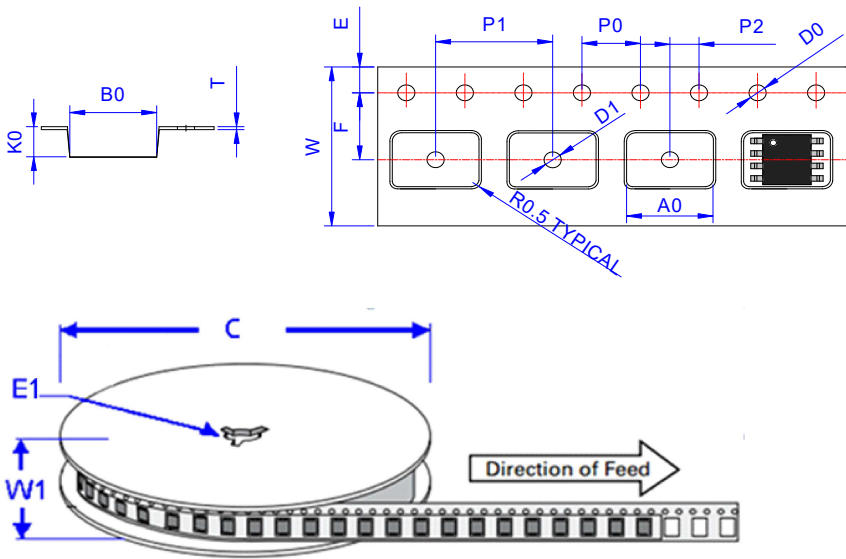

| Symbol | Millimeters | Inches |
|--------|-------------|--------|
| | Typ. | Typ. |
| A0 | 6.40 | 0.252 |
| B0 | 5.30 | 0.209 |
| C | 330 | 13.0 |
| D0 | 1.50 | 0.059 |
| D1 | 1.50 | 0.059 |
| E1 | 13.30 | 0.524 |
| E | 1.75 | 0.069 |
| F | 5.50 | 0.217 |
| K0 | 2.10 | 0.083 |
| P0 | 4.00 | 0.157 |
| P1 | 8.00 | 0.315 |
| P2 | 2.00 | 0.079 |
| T | 0.24 | 0.009 |
| W | 12.00 | 0.472 |
| W1 | 15.70 | 0.618 |

| PART No. | PACKAGE TYPE | QUANTITY(PCS) REEL | DESCRIPTION |
|------------|--------------|-----------------------|-------------------|
| JEU05-4RDA | SOP-8 | 4,000 | 13 inch reel pack |

MARKING CODE

| Part Number | Marking Code |
|-------------|--|
| JEU05-4RDA | <p>05-4RDAXX</p> <p>05-4RDA: Device code XX: Date code</p> |

JieJie products are not designed for, and shall not be used for, any purpose (including, without limitation, automotive, military, aerospace, medical, life-saving, life-sustaining or nuclear facility applications, devices intended for surgical implant into the body, or any other application in which the failure or lack of desired operation of the product may result in personal injury, death, or property damage) other than those expressly set forth in applicable JieJie product documentation. Warranties granted by JieJie shall be deemed void for products used for any purpose not expressly set forth in applicable JieJie documentation. JieJie shall not be liable for any claims or damages arising out of products used in applications not expressly intended by JieJie as set forth in applicable JieJie documentation. The sale and use of JieJie products is subject to JieJie terms and conditions of sale, unless otherwise agreed by JieJie.

Information furnished in this document is believed to be accurate and reliable. However, Jiangsu JieJie Microelectronics Co., Ltd. assumes no responsibility for the consequences of use without consideration for such information nor use beyond it.

Information mentioned in this document is subject to change without notice, apart from that when an agreement is signed, Jiangsu JieJie complies with the agreement.

Products and information provided in this document have no infringement of patents. Jiangsu JieJie assumes no responsibility for any infringement of other rights of third parties which may result from the use of such products and information.

This document is the 1.5th version which is made in 14-Dec.-2022. This document supersedes and replaces all information previously supplied.

 is a registered trademark of Jiangsu JieJie Microelectronics Co., Ltd.

Copyright ©2022 Jiangsu JieJie Microelectronics Co., Ltd. Printed All rights reserved.